



Bridgelux® E Series E8 CA LED Array

Product Data Sheet DS336

Introduction

E Series

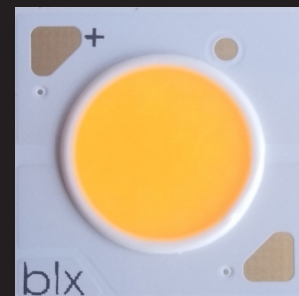

The Bridgelux E Series LED array products deliver high quality light in a compact and high cost-effective solid-state lighting package. These chip-on-board (COB) arrays can be efficiently driven at twice the nominal drive current, enabling design flexibility not previously possible. The E Series E8 CA is designed to support a wide range of luminaires and replacement lamps for both indoor and outdoor general lighting applications with highly competitive cost and good performance.

E Series E8 CA is available in a variety of electrical, CCT and CRI combinations providing substantial design flexibility and energy efficiencies.

Typical applications include, replacement lamps, and task, accent, spot, track, wide area, security, wall pack and down lights.

Features

- Compact, high flux density light source
- Uniform, high quality illumination
- Streamlined thermal path
- ENERGY STAR® / ANSI compliant color binning structure with 2, 3 and 4 SDCM options
- Higher energy efficiency than incandescent, halogen and CFL lamps
- Industry standard DC voltage operation
- Instant light with unlimited dimming
- RoHS and REACH compliant

Benefits

- Easy for second optics design
- Clean white light without pixilation
- Significantly reduced thermal resistance
- Easy for LED driver selection
- Easy to use with daylight and motion detectors to enable increased energy savings
- Reduced maintenance costs
- Environmentally friendly



Contents

Product Feature Map	2
Product Nomenclature	2
Product Selection Guide	3
Performance at Commonly Used Drive Currents	7
Electrical Characteristics	15
Absolute Maximum Ratings	16
Performance Curves	17
Typical Radiation Pattern	23
Typical Color Spectrum	24
Operating Limits	25
Color Binning Information	27
Mechanical Dimensions	29
Packaging and Labeling	30
Design Resources	32
About Bridgelux	33

Product Feature Map

Bridgelux arrays are fully engineered devices that provide consistent thermal and optical performance on an engineered mechanical platform.

The arrays incorporate several features to simplify design integration and assembly.

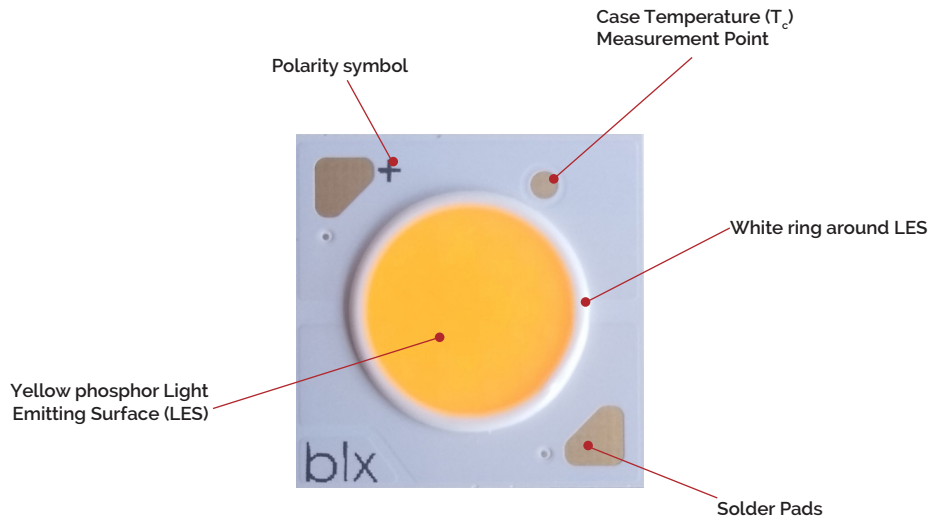

Note: Part number and lot codes are scribed on back of array

Product Nomenclature

The part number designation for Bridgelux E Series LED arrays is explained as follows:

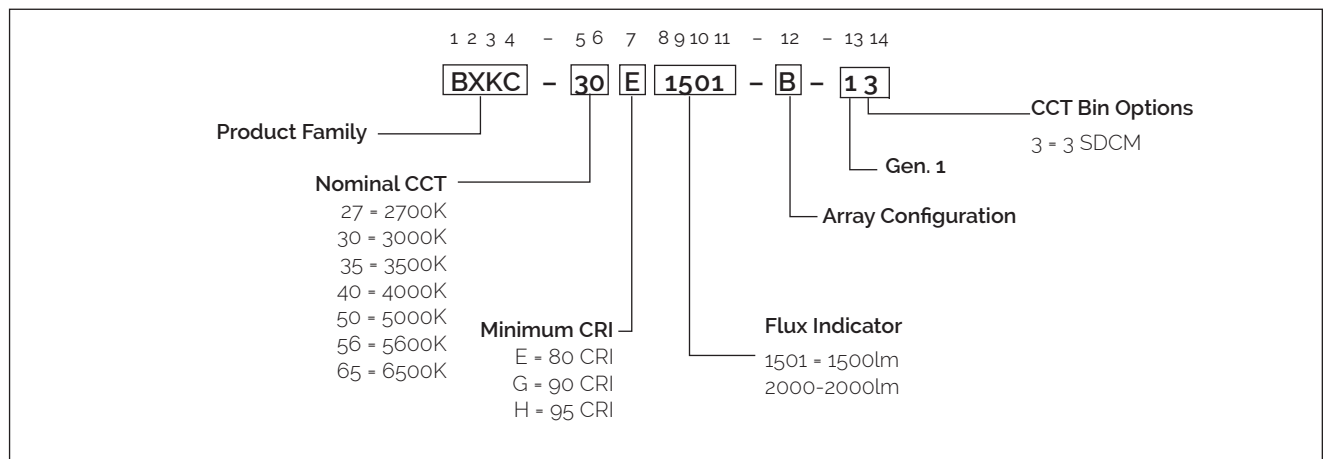

Product Selection Guide

Table 1: Selection Guide, Measurement Data (Tc=25°C)

Part Number	Nominal CCT ¹ (K)	Minimum CRI	Typical CRI	Nominal Drive Current (mA)	Typical Pulsed Flux ^{2,3,4} Tc = 25°C (lm)	Minimum Pulsed Flux ^{2,4,5} Tc = 25°C (lm)	Typical Vf (V)	Typical Power (W)	Typical Efficacy (lm/W)
BXKC-27E1501-B-13	2700	80	82	200	1020	887	35.5	7.1	144
BXKC-27G1501-B-13	2700	90	92	200	840	731	35.5	7.1	118
BXKC-27H1501-B-13	2700	95	96	200	817	711	35.5	7.1	115
BXKC-30E1501-B-13	3000	80	82	200	1077	937	35.5	7.1	152
BXKC-30G1501-B-13	3000	90	92	200	881	766	35.5	7.1	124
BXKC-30H1501-B-13	3000	95	96	200	830	722	35.5	7.1	117
BXKC-35E1501-B-13	3500	80	82	200	1099	956	35.5	7.1	155
BXKC-35G1501-B-13	3500	90	92	200	904	786	35.5	7.1	127
BXKC-35H1501-B-13	3500	95	96	200	875	761	35.5	7.1	123
BXKC-40E1501-B-13	4000	80	82	200	1109	965	35.5	7.1	156
BXKC-40G1501-B-13	4000	90	92	200	935	813	35.5	7.1	132
BXKC-40H1501-B-13	4000	95	96	200	905	787	35.5	7.1	127
BXKC-50E1501-B-14	5000	80	81.5	200	1143	994	35.5	7.1	161
BXKC-50G1501-B-14	5000	90	91	200	958	833	35.5	7.1	135
BXKC-56E1501-B-14	5600	80	81.5	200	1143	994	35.5	7.1	161
BXKC-65E1501-B-14	6500	80	81.5	200	1143	994	35.5	7.1	161
BXKC-27E1501-D-13	2700	80	82	400	1020	887	17.8	7.1	144
BXKC-27G1501-D-13	2700	90	92	400	840	731	17.8	7.1	118
BXKC-30E1501-D-13	3000	80	82	400	1077	937	17.8	7.1	152
BXKC-30G1501-D-13	3000	90	92	400	881	766	17.8	7.1	124
BXKC-35E1501-D-13	3500	80	82	400	1099	956	17.8	7.1	155
BXKC-35G1501-D-13	3500	90	92	400	904	786	17.8	7.1	127
BXKC-40E1501-D-13	4000	80	82	400	1109	965	17.8	7.1	156
BXKC-40G1501-D-13	4000	90	92	400	935	813	17.8	7.1	132
BXKC-50E1501-D-14	5000	80	81.5	400	1143	994	17.8	7.1	161
BXKC-50G1501-D-14	5000	90	91	400	958	833	17.8	7.1	135
BXKC-56E1501-D-14	5600	80	81.5	400	1143	994	17.8	7.1	161
BXKC-65E1501-D-14	6500	80	81.5	400	1143	994	17.8	7.1	161
BXKC-27E2000-C-13	2700	80	82	350	1704	1483	36.0	12.6	135
BXKC-27G2000-C-13	2700	90	92	350	1449	1260	36.0	12.6	115
BXKC-30E2000-C-13	3000	80	82	350	1794	1561	36.0	12.6	142
BXKC-30G2000-C-13	3000	90	92	350	1525	1327	36.0	12.6	121
BXKC-35E2000-C-13	3500	80	82	350	1857	1616	36.0	12.6	147
BXKC-35G2000-C-13	3500	90	92	350	1578	1373	36.0	12.6	125
BXKC-40E2000-C-13	4000	80	82	350	1916	1667	36.0	12.6	152
BXKC-40G2000-C-13	4000	90	92	350	1629	1417	36.0	12.6	129

Notes for Table 1:

1. Nominal CCT as defined by ANSI C78.377-2011.
2. Products tested under pulsed condition (10ms pulse width) at nominal test current where Tj (junction temperature) = Tc (case temperature) = 25°C.
3. Typical performance values are provided as a reference only and are not a guarantee of performance.
4. Bridgelux maintains a ±7% tolerance on flux measurements.
5. Minimum flux values at the nominal test current are guaranteed by 100% test.

Product Selection Guide

Table 1: Selection Guide, Measurement Data (Tc=25°C)

Part Number	Nominal CCT ¹ (K)	Minimum CRI	Typical CRI	Nominal Drive Current (mA)	Typical Pulsed Flux ^{2,3,4} Tc = 25°C (lm)	Minimum Pulsed Flux ^{2,4,5} Tc = 25°C (lm)	Typical Vf (V)	Typical Power (W)	Typical Efficacy (lm/W)
BXKC-50E2000-C-14	5000	80	81.5	350	1929	1678	36.0	12.6	153
BXKC-50G2000-C-14	5000	90	91	350	1639	1426	36.0	12.6	130
BXKC-56E2000-C-14	5600	80	81.5	350	1929	1678	36.0	12.6	153
BXKC-65E2000-C-14	6500	80	81.5	350	1929	1678	36.0	12.6	153
BXKC-27G2000-M-13	2700	90	92	350	1720	1496	45.2	15.82	109
BXKC-30G2000-M-13	3000	90	92	350	1790	1557	45.2	15.82	113
BXKC-40G2000-M-13	4000	90	92	350	1910	1662	45.2	15.82	121
BXKC-35G2000-M-13	3500	90	92	350	1840	1601	45.2	15.82	116

Notes for Table 1:

1. Nominal CCT as defined by ANSI C78.377-2011.
2. Products tested under pulsed condition (10ms pulse width) at nominal test current where Tj (junction temperature) = Tc (case temperature) = 25°C.
3. Typical performance values are provided as a reference only and are not a guarantee of performance.
4. Bridgelux maintains a ±7% tolerance on flux measurements.
5. Minimum flux values at the nominal test current are guaranteed by 100% test.

Product Selection Guide

Table 2: Selection Guide, Measurement Data (Tc=85°C)

Part Number	Nominal CCT* (K)	Minumum CRI	Typical CRI	Nominal Drive Current (mA)	Typical DC Flux ^{2,3} Tc = 85°C (lm)	Minimum DC Flux ⁴ Tc = 85°C (lm)	Typical Vf (V)	Typical Power (W)	Typical Efficacy (lm/W)
BXKC-27E1501-B-13	2700	80	82	200	919	799	34.9	7.0	132
BXKC-27G1501-B-13	2700	90	92	200	757	658	34.9	7.0	109
BXKC-27H1501-B-13	2700	95	96	200	736	640	34.9	7.0	106
BXKC-30E1501-B-13	3000	80	82	200	970	844	34.9	7.0	139
BXKC-30G1501-B-13	3000	90	92	200	794	690	34.9	7.0	114
BXKC-30H1501-B-13	3000	95	96	200	748	650	34.9	7.0	107
BXKC-35E1501-B-13	3500	80	82	200	990	861	34.9	7.0	142
BXKC-35G1501-B-13	3500	90	92	200	814	708	34.9	7.0	117
BXKC-35H1501-B-13	3500	95	96	200	788	686	34.9	7.0	113
BXKC-40E1501-B-13	4000	80	82	200	999	869	34.9	7.0	143
BXKC-40G1501-B-13	4000	90	92	200	842	733	34.9	7.0	121
BXKC-40H1501-B-13	4000	95	96	200	815	709	34.9	7.0	117
BXKC-50E1501-B-14	5000	80	81.5	200	1030	896	34.9	7.0	148
BXKC-50G1501-B-14	5000	90	91	200	863	751	34.9	7.0	124
BXKC-56E1501-B-14	5600	80	81.5	200	1030	896	34.9	7.0	148
BXKC-65E1501-B-14	6500	80	81.5	200	1030	896	34.9	7.0	148
BXKC-27E1501-D-13	2700	80	82	400	919	799	17.4	7.0	132
BXKC-27G1501-D-13	2700	90	92	400	757	658	17.4	7.0	109
BXKC-30E1501-D-13	3000	80	82	400	970	844	17.4	7.0	139
BXKC-30G1501-D-13	3000	90	92	400	794	690	17.4	7.0	114
BXKC-35E1501-D-13	3500	80	82	400	990	861	17.4	7.0	142
BXKC-35G1501-D-13	3500	90	92	400	814	708	17.4	7.0	117
BXKC-40E1501-D-13	4000	80	82	400	999	869	17.4	7.0	143
BXKC-40G1501-D-13	4000	90	92	400	842	733	17.4	7.0	121
BXKC-50E1501-D-14	5000	80	81.5	400	1030	896	17.4	7.0	148
BXKC-50G1501-D-14	5000	90	91	400	863	751	17.4	7.0	124
BXKC-56E1501-D-14	5600	80	81.5	400	1030	896	17.4	7.0	148
BXKC-65E1501-D-14	6500	80	81.5	400	1030	896	17.4	7.0	148
BXKC-27E2000-C-13	2700	80	82	350	1534	1335	35.5	12.4	123
BXKC-27G2000-C-13	2700	90	92	350	1304	1134	35.5	12.4	105
BXKC-30E2000-C-13	3000	80	82	350	1615	1405	35.5	12.4	130
BXKC-30G2000-C-13	3000	90	92	350	1373	1194	35.5	12.4	110
BXKC-35E2000-C-13	3500	80	82	350	1671	1454	35.5	12.4	135
BXKC-35G2000-C-13	3500	90	92	350	1421	1236	35.5	12.4	114
BXKC-40E2000-C-13	4000	80	82	350	1725	1500	35.5	12.4	139
BXKC-40G2000-C-13	4000	90	92	350	1466	1275	35.5	12.4	118

Product Selection Guide

Table 2: Selection Guide, Measurement Data (Tc=85°C)

Part Number	Nominal CCT ¹ (K)	Minimum CRI	Typical CRI	Nominal Drive Current (mA)	Typical DC Flux ^{2,3} Tc = 85°C (lm)	Minimum DC Flux ⁴ Tc = 85°C (lm)	Typical Vf (V)	Typical Power (W)	Typical Efficacy (lm/W)
BXKC-50E2000-C-14	5000	80	81.5	350	1736	1510	35.5	12.4	140
BXKC-50G2000-C-14	5000	90	91	350	1475	1284	35.5	12.4	119
BXKC-56E2000-C-14	5600	80	81.5	350	1736	1510	35.5	12.4	140
BXKC-65E2000-C-14	6500	80	81.5	350	1736	1510	35.5	12.4	140
BXKC-27G2000-M-13	2700	90	92	350	1548	1347	44.3	15.5	100
BXKC-30G2000-M-13	3000	90	92	350	1611	1402	44.3	15.5	104
BXKC-40G2000-M-13	4000	90	92	350	1719	1496	44.3	15.5	111
BXKC-35G2000-M-13	3500	90	92	350	1656	1441	44.3	15.5	107

Notes for Table 2:

1. Nominal CCT as defined by ANSI C78.377-2011.
2. Typical stabilized DC performance values are provided as reference only and are not a guarantee of performance.
3. Typical performance is estimated based on operation under DC (direct current) with LED array mounted onto a heat sink with thermal interface material and the case temperature maintained at 85°C. Based on Bridgelux test setup, values may vary depending on the thermal design of the luminaire and/or the exposed environment to which the product is subjected.
4. Minimum flux values at elevated temperatures are provided for reference only and are not guaranteed by 100% production testing. Based on Bridgelux test setup, values may vary depending on the thermal design of the luminaire and/or the exposed environment to which the product is subjected.

Performance at Commonly Used Drive Currents

E Series LED arrays are tested to the specifications shown using the nominal drive currents in Table 1. E Series may also be driven at other drive currents dependent on specific application design requirements. The performance at any drive current can be derived from the current vs. voltage characteristics shown in Figures 1,2 and 3 and the flux vs. current characteristics shown in Figures 4,5 and 6. The performance at commonly used drive currents is summarized in Table 3.

Table 3: Product Performance at Commonly Used Drive Currents (Continued)

Part Number	Minimum CRI	Drive Current ¹ (mA)	Typical Vf Tc = 25°C (V)	Typical Power ² Tc = 25°C (W)	Typical Pulsed Flux ² Tc = 25°C (lm)	Typical DC Flux ² Tc = 85°C (lm)	Typical Efficacy ² Tc = 25°C (lm/W)
BXKC-27E1501-B-13	80	50	31.9	1.6	283	261	177
		100	33.1	3.3	548	501	165
		200	35.5	7.1	1020	919	144
		300	37.3	11.2	1445	1278	129
		400	38.9	15.6	1821	1584	117
		480	40.3	19.4	2082	1789	108
BXKC-27G1501-B-13	90	50	31.9	1.6	233	215	146
		100	33.1	3.3	451	413	136
		200	35.5	7.1	840	757	118
		300	37.3	11.2	1190	1053	106
		400	38.9	15.6	1500	1305	96
		480	40.3	19.4	1715	1473	89
BXKC-27H1501-B-13	95	50	31.9	1.6	227	209	142
		100	33.1	3.3	439	402	132
		200	35.5	7.1	817	736	115
		300	37.3	11.2	1157	1024	103
		400	38.9	15.6	1459	1269	94
		480	40.3	19.4	1668	1433	86
BXKC-30E1501-B-13	80	50	31.9	1.6	299	276	187
		100	33.1	3.3	578	529	175
		200	35.5	7.1	1077	970	152
		300	37.3	11.2	1525	1350	136
		400	38.9	15.6	1923	1673	124
		480	40.3	19.4	2198	1889	114
BXKC-30G1501-B-13	90	50	31.9	1.6	245	226	153
		100	33.1	3.3	473	433	143
		200	35.5	7.1	881	794	124
		300	37.3	11.2	1248	1104	112
		400	38.9	15.6	1573	1368	101
		480	40.3	19.4	1798	1545	93

Notes for Table 3:

1. Alternate drive currents are provided for reference only and are not a guarantee of performance.
2. Typical stabilized DC performance values are provided as reference only and are not a guarantee of performance.

Performance at Commonly Used Drive Currents

Table 3: Product Performance at Commonly Used Drive Currents (Continued)

Part Number	Minimum CRI	Drive Current ¹ (mA)	Typical Vf Tc = 25°C (V)	Typical Power ² Tc = 25°C (W)	Typical Pulsed Flux ² Tc = 25°C (lm)	Typical DC Flux ² Tc = 85°C (lm)	Typical Efficacy ² Tc = 25°C (lm/W)
BXKC-30H1501-B-13	95	50	31.9	1.6	230	213	144
		100	33.1	3.3	446	408	135
		200	35.5	7.1	830	748	117
		300	37.3	11.2	1175	1040	105
		400	38.9	15.6	1482	1289	95
		480	40.3	19.4	1694	1456	87
BXKC-35E1501-B-13	80	50	31.9	1.6	305	281	191
		100	33.1	3.3	590	540	178
		200	35.5	7.1	1099	990	155
		300	37.3	11.2	1556	1378	139
		400	38.9	15.6	1962	1707	126
		480	40.3	19.4	2243	1927	116
BXKC-35G1501-B-13	90	50	31.9	1.6	251	232	157
		100	33.1	3.3	485	444	147
		200	35.5	7.1	904	814	127
		300	37.3	11.2	1280	1133	114
		400	38.9	15.6	1614	1404	104
		480	40.3	19.4	1845	1585	95
BXKC-35H1501-B-13	95	50	31.9	1.6	243	224	152
		100	33.1	3.3	470	430	142
		200	35.5	7.1	875	788	123
		300	37.3	11.2	1239	1097	111
		400	38.9	15.6	1562	1359	100
		480	40.3	19.4	1786	1535	92
BXKC-40E1501-B-13	80	50	31.9	1.6	308	284	193
		100	33.1	3.3	595	545	180
		200	35.5	7.1	1109	999	156
		300	37.3	11.2	1571	1390	140
		400	38.9	15.6	1980	1722	127
		480	40.3	19.4	2264	1945	117
BXKC-40G1501-B-13	90	50	31.9	1.6	259	239	163
		100	33.1	3.3	502	460	152
		200	35.5	7.1	935	842	132
		300	37.3	11.2	1324	1172	118
		400	38.9	15.6	1669	1452	107
		480	40.3	19.4	1909	1640	99

Notes for Table 3:

1. Alternate drive currents are provided for reference only and are not a guarantee of performance.
2. Typical stabilized DC performance values are provided as reference only and are not a guarantee of performance.

Performance at Commonly Used Drive Currents

Table 3: Product Performance at Commonly Used Drive Currents (Continued)

Part Number	Minimum CRI	Drive Current ¹ (mA)	Typical Vf Tc = 25°C (V)	Typical Power ² Tc = 25°C (W)	Typical Pulsed Flux ² Tc = 25°C (lm)	Typical DC Flux ² Tc = 85°C (lm)	Typical Efficacy ² Tc = 25°C (lm/W)
BXKC-40H1501-B-13	95	50	31.9	1.6	251	232	157
		100	33.1	3.3	486	445	147
		200	35.5	7.1	905	815	127
		300	37.3	11.2	1282	1134	115
		400	38.9	15.6	1616	1405	104
		480	40.3	19.4	1847	1587	95
BXKC-50E1501-B-14	80	50	31.9	1.6	317	293	199
		100	33.1	3.3	614	562	185
		200	35.5	7.1	1143	1030	161
		300	37.3	11.2	1619	1433	145
		400	38.9	15.6	2041	1775	131
		480	40.3	19.4	2333	2005	120
BXKC-50G1501-B-14	90	50	31.9	1.6	266	245	167
		100	33.1	3.3	514	471	155
		200	35.5	7.1	958	863	135
		300	37.3	11.2	1357	1201	121
		400	38.9	15.6	1710	1488	110
		480	40.3	19.4	1955	1680	101
BXKC-56E1501-B-14	80	50	31.9	1.6	317	293	199
		100	33.1	3.3	614	562	185
		200	35.5	7.1	1143	1030	161
		300	37.3	11.2	1619	1433	145
		400	38.9	15.6	2041	1775	131
		480	40.3	19.4	2333	2005	120
BXKC-65E1501-B-14	80	50	31.9	1.6	317	293	199
		100	33.1	3.3	614	562	185
		200	35.5	7.1	1143	1030	161
		300	37.3	11.2	1619	1433	145
		400	38.9	15.6	2041	1775	131
		480	40.3	19.4	2333	2005	120
BXKC-27E1501-D-13	80	100	16.0	1.6	283	261	177
		200	16.6	3.3	548	501	165
		400	17.8	7.1	1020	919	144
		600	18.6	11.2	1445	1278	129
		800	19.5	15.6	1821	1584	117
		960	20.2	19.4	2082	1789	108

Notes for Table 3:

1. Alternate drive currents are provided for reference only and are not a guarantee of performance.
2. Typical stabilized DC performance values are provided as reference only and are not a guarantee of performance.

Performance at Commonly Used Drive Currents

Table 3: Product Performance at Commonly Used Drive Currents (Continued)

Part Number	Minimum CRI	Drive Current ¹ (mA)	Typical Vf Tc = 25°C (V)	Typical Power ² Tc = 25°C (W)	Typical Pulsed Flux ² Tc = 25°C (lm)	Typical DC Flux ² Tc = 85°C (lm)	Typical Efficacy ² Tc = 25°C (lm/W)
BXKC-27G1501-D-13	90	100	16.0	1.6	233	215	146
		200	16.6	3.3	451	413	136
		400	17.8	7.1	840	757	118
		600	18.6	11.2	1190	1053	106
		800	19.5	15.6	1500	1305	96
		960	20.2	19.4	1715	1473	89
BXKC-30E1501-D-13	80	100	16.0	1.6	299	276	187
		200	16.6	3.3	578	529	175
		400	17.8	7.1	1077	970	152
		600	18.6	11.2	1525	1350	136
		800	19.5	15.6	1923	1673	124
		960	20.2	19.4	2198	1889	114
BXKC-30G1501-D-13	90	100	16.0	1.6	245	226	153
		200	16.6	3.3	473	433	143
		400	17.8	7.1	881	794	124
		600	18.6	11.2	1248	1104	112
		800	19.5	15.6	1573	1368	101
		960	20.2	19.4	1798	1545	93
BXKC-35E1501-D-13	80	100	16.0	1.6	305	281	191
		200	16.6	3.3	590	540	178
		400	17.8	7.1	1099	990	155
		600	18.6	11.2	1556	1378	139
		800	19.5	15.6	1962	1707	126
		960	20.2	19.4	2243	1927	116
BXKC-35G1501-D-13	90	100	16.0	1.6	251	232	157
		200	16.6	3.3	485	444	147
		400	17.8	7.1	904	814	127
		600	18.6	11.2	1280	1133	114
		800	19.5	15.6	1614	1404	104
		960	20.2	19.4	1845	1585	95
BXKC-40E1501-D-13	80	100	16.0	1.6	308	284	193
		200	16.6	3.3	595	545	180
		400	17.8	7.1	1109	999	156
		600	18.6	11.2	1571	1390	140
		800	19.5	15.6	1980	1722	127
		960	20.2	19.4	2264	1945	117

Notes for Table 3:

1. Alternate drive currents are provided for reference only and are not a guarantee of performance.
2. Typical stabilized DC performance values are provided as reference only and are not a guarantee of performance.

Performance at Commonly Used Drive Currents

Table 3: Product Performance at Commonly Used Drive Currents (Continued)

Part Number	Minimum CRI	Drive Current ¹ (mA)	Typical Vf Tc = 25°C (V)	Typical Power ² Tc = 25°C (W)	Typical Pulsed Flux ² Tc = 25°C (lm)	Typical DC Flux ² Tc = 85°C (lm)	Typical Efficacy ² Tc = 25°C (lm/W)
BXKC-40G1501-D-13	90	100	16.0	1.6	259	239	163
		200	16.6	3.3	502	460	152
		400	17.8	7.1	935	842	132
		600	18.6	11.2	1324	1172	118
		800	19.5	15.6	1669	1452	107
		960	20.2	19.4	1909	1640	99
BXKC-50E1501-D-14	80	100	16.0	1.6	317	293	199
		200	16.6	3.3	614	562	185
		400	17.8	7.1	1143	1030	161
		600	18.6	11.2	1619	1433	145
		800	19.5	15.6	2041	1775	131
		960	20.2	19.4	2333	2005	120
BXKC-50G1501-D-14	90	100	16.0	1.6	266	245	167
		200	16.6	3.3	514	471	155
		400	17.8	7.1	958	863	135
		600	18.6	11.2	1357	1201	121
		800	19.5	15.6	1710	1488	110
		960	20.2	19.4	1955	1680	101
BXKC-56E1501-D-14	80	100	16.0	1.6	317	293	199
		200	16.6	3.3	614	562	185
		400	17.8	7.1	1143	1030	161
		600	18.6	11.2	1619	1433	145
		800	19.5	15.6	2041	1775	131
		960	20.2	19.4	2333	2005	120
BXKC-65E1501-D-14	80	100	16.0	1.6	317	293	199
		200	16.6	3.3	614	562	185
		400	17.8	7.1	1143	1030	161
		600	18.6	11.2	1619	1433	145
		800	19.5	15.6	2041	1775	131
		960	20.2	19.4	2333	2005	120
BXKC-27E2000-C-13	80	90	32.8	3.0	486	443	165
		180	34.0	6.1	942	853	154
		350	36.0	12.6	1704	1534	135
		360	36.1	13.0	1749	1572	135
		540	38.1	20.6	2473	2179	120
		720	40.0	28.8	3110	2681	108

Notes for Table 3:

1. Alternate drive currents are provided for reference only and are not a guarantee of performance.
2. Typical stabilized DC performance values are provided as reference only and are not a guarantee of performance.

Performance at Commonly Used Drive Currents

Table 3: Product Performance at Commonly Used Drive Currents (Continued)

Part Number	Minimum CRI	Drive Current ¹ (mA)	Typical Vf Tc = 25°C (V)	Typical Power ² Tc = 25°C (W)	Typical Pulsed Flux ² Tc = 25°C (lm)	Typical DC Flux ² Tc = 85°C (lm)	Typical Efficacy ² Tc = 25°C (lm/W)
BXKC-27G2000-C-13	90	90	32.8	3.0	413	377	140
		180	34.0	6.1	801	725	131
		350	36.0	12.6	1449	1304	115
		360	36.1	13.0	1486	1336	114
		540	38.1	20.6	2102	1852	102
		720	40.0	28.8	2643	2278	92
BXKC-30E2000-C-13	80	90	32.8	3.0	512	466	173
		180	34.0	6.1	992	898	162
		350	36.0	12.6	1794	1615	142
		360	36.1	13.0	1841	1655	142
		540	38.1	20.6	2603	2294	127
		720	40.0	28.8	3273	2822	114
BXKC-30G2000-C-13	90	90	32.8	3.0	435	396	147
		180	34.0	6.1	843	763	138
		350	36.0	12.6	1525	1373	121
		360	36.1	13.0	1565	1406	120
		540	38.1	20.6	2212	1950	108
		720	40.0	28.8	2782	2398	97
BXKC-35E2000-C-13	80	90	32.8	3.0	530	483	179
		180	34.0	6.1	1027	929	168
		350	36.0	12.6	1857	1671	147
		360	36.1	13.0	1905	1713	147
		540	38.1	20.6	2694	2374	131
		720	40.0	28.8	3388	2920	118
BXKC-35G2000-C-13	90	90	32.8	3.0	450	410	152
		180	34.0	6.1	873	790	142
		350	36.0	12.6	1578	1421	125
		360	36.1	13.0	1619	1456	125
		540	38.1	20.6	2290	2018	111
		720	40.0	28.8	2880	2482	100
BXKC-40E2000-C-13	80	90	32.8	3.0	547	498	185
		180	34.0	6.1	1059	959	173
		350	36.0	12.6	1916	1725	152
		360	36.1	13.0	1966	1767	151
		540	38.1	20.6	2780	2450	135
		720	40.0	28.8	3496	3013	121

Notes for Table 3:

1. Alternate drive currents are provided for reference only and are not a guarantee of performance.
2. Typical stabilized DC performance values are provided as reference only and are not a guarantee of performance.

Performance at Commonly Used Drive Currents

Table 3: Product Performance at Commonly Used Drive Currents (Continued)

Part Number	Minimum CRI	Drive Current ¹ (mA)	Typical Vf Tc = 25°C (V)	Typical Power ² Tc = 25°C (W)	Typical Pulsed Flux ² Tc = 25°C (lm)	Typical DC Flux ² Tc = 85°C (lm)	Typical Efficacy ² Tc = 25°C (lm/W)
BXKC-40G2000-C-13	90	90	32.8	3.0	465	423	157
		180	34.0	6.1	901	815	147
		350	36.0	12.6	1629	1466	129
		360	36.1	13.0	1671	1502	129
		540	38.1	20.6	2363	2082	115
		720	40.0	28.8	2972	2561	103
BXKC-50E2000-C-14	80	90	32.8	3.0	550	501	186
		180	34.0	6.1	1066	965	174
		350	36.0	12.6	1929	1736	153
		360	36.1	13.0	1979	1779	152
		540	38.1	20.6	2798	2466	136
		720	40.0	28.8	3519	3033	122
BXKC-50G2000-C-14	90	90	32.8	3.0	468	426	158
		180	34.0	6.1	906	820	148
		350	36.0	12.6	1639	1475	130
		360	36.1	13.0	1682	1512	129
		540	38.1	20.6	2378	2096	116
		720	40.0	28.8	2991	2578	104
BXKC-56E2000-C-14	80	90	32.8	3.0	550	501	186
		180	34.0	6.1	1066	965	174
		350	36.0	12.6	1929	1736	153
		360	36.1	13.0	1979	1779	152
		540	38.1	20.6	2798	2466	136
		720	40.0	28.8	3519	3033	122
BXKC-65E2000-C-14	80	90	32.8	3.0	550	501	186
		180	34.0	6.1	1066	965	174
		350	36.0	12.6	1929	1736	153
		360	36.1	13.0	1979	1779	152
		540	38.1	20.6	2798	2466	136
		720	40.0	28.8	3519	3033	122
BXKC-27G2000-M-13	90	90	41.0	3.7	492	454	133
		180	42.6	7.7	951	872	124
		350	45.2	15.8	1720	1548	109
		360	45.3	16.3	1760	1585	108
		540	47.8	25.8	2505	2183	97
		720	50.2	36.1	3115	2667	86

Notes for Table 3:

1. Alternate drive currents are provided for reference only and are not a guarantee of performance.
2. Typical stabilized DC performance values are provided as reference only and are not a guarantee of performance.

Performance at Commonly Used Drive Currents

Table 3: Product Performance at Commonly Used Drive Currents (Continued)

Part Number	Minimum CRI	Drive Current ¹ (mA)	Typical Vf Tc = 25°C (V)	Typical Power ² Tc = 25°C (W)	Typical Pulsed Flux ² Tc = 25°C (lm)	Typical DC Flux ² Tc = 85°C (lm)	Typical Efficacy ² Tc = 25°C (lm/W)
BXKC-30G2000-M-13	90	90	41.0	3.7	512	473	139
		180	42.6	7.7	989	907	129
		350	45.2	15.8	1790	1611	113
		360	45.3	16.3	1831	1649	112
		540	47.8	25.8	2607	2271	101
		720	50.2	36.1	3242	2775	90
BXKC-40G2000-M-13	90	90	41.0	3.7	546	505	148
		180	42.6	7.7	1056	968	138
		350	45.2	15.8	1910	1719	121
		360	45.3	16.3	1954	1760	120
		540	47.8	25.8	2782	2424	108
		720	50.2	36.1	3460	2961	96
BXKC-35G2000-M-13	90	90	41.0	3.7	526	486	142
		180	42.6	7.7	1017	933	133
		350	45.2	15.8	1840	1656	116
		360	45.3	16.3	1882	1695	115
		540	47.8	25.8	2680	2335	104
		720	50.2	36.1	3333	2853	92

Notes for Table 3:

1. Alternate drive currents are provided for reference only and are not a guarantee of performance.
2. Typical stabilized DC performance values are provided as reference only and are not a guarantee of performance.

Electrical Characteristics

Table 4: Electrical Characteristics

Part Number	Drive Current (mA)	Forward Voltage Pulsed, T _c = 25°C (V) ^{1,2,3}			Typical Coefficient of Forward Voltage ⁴ Vf/Tc (mV/°C)	Typical Thermal Resistance Junction to Case ^{5,6} Rj-c (°C/W)	Driver Selection Voltages ⁶ (V)	
		Minimum	Typical	Maximum			Vf Min. Hot ⁷ Tc = 105°C (V)	Vf Max. Cold ⁷ Tc = -40°C (V)
BXKC-xxx150x-B-1x	200	32.0	35.5	38.7	10.5	1.0	30.7	39.6
BXKC-xxx150x-D-1x	400	16.0	17.8	19.3	5.25	1.0	15.4	19.8
BXKC-xxx2000-C-1x	350	32.4	36.0	39.2	13.7	0.57	31.8	40.2
BXKC-xxx2000-M-1x	350	40.68	45.2	49.3	16.8	0.56	39.6	50.5

Notes for Table 4:

1. Parts are tested in pulsed conditions, T_c = 25°C. Pulse width is 10ms.
2. Voltage minimum and maximum are provided for reference only and are not a guarantee of performance.
3. Bridgelux maintains a tester tolerance of ± 0.10V on forward voltage measurements.
4. Typical coefficient of forward voltage tolerance is ± 0.1mV for nominal current.
5. Thermal resistance values are based from test data of a 3000K 80 CRI product.
6. Thermal resistance value was calculated using total electrical input power; optical power was not subtracted from input power. The thermal interface material used during testing is not included in the thermal resistance value.
7. Vf min hot and max cold values are provided as reference only and are not guaranteed by test. These values are provided to aid in driver design and selection over the operating range of the product.

Absolute Maximum Ratings

Table 5 : Maximum Ratings

Parameter	Maximum Rating			
LED Junction Temperature (T_j)	125°C			
Storage Temperature	-40°C to +105°C			
Operating Case Temperature ¹ (T_c)	105°C			
Soldering Temperature ³	300°C or lower for a maximum of 6 seconds			
	BXKC-xxx150x-B-1x	BXKC-xxx150x-D-1x	BXKC-xxx2000-C-1x	BXKC-xxx2000-M-1x
Maximum Drive Current ^{2,4}	480 mA	960 mA	720 mA	720 mA
Maximum Reverse Voltage ⁵	-60 V	-30 V	-60 V	-75 V

Notes for Table 5:

1. For IEC 62717 requirement, please consult your Bridgelux sales representative.
2. Arrays may be driven at higher currents however lumen maintenance may be reduced.
3. See Bridgelux Application Notes for more information.
4. Bridgelux recommends a maximum duty cycle of 10% and pulse width of 20 ms when operating LED Arrays at maximum peak pulsed current specified. Maximum peak pulsed currents indicate values where LED Arrays can be driven without catastrophic failures.
5. Light emitting diodes are not designed to be driven in reverse voltage and will not produce light under this condition. Maximum rating provided for reference only.

Performance Curves

Figure 1: Forward Voltage vs. Forward Current

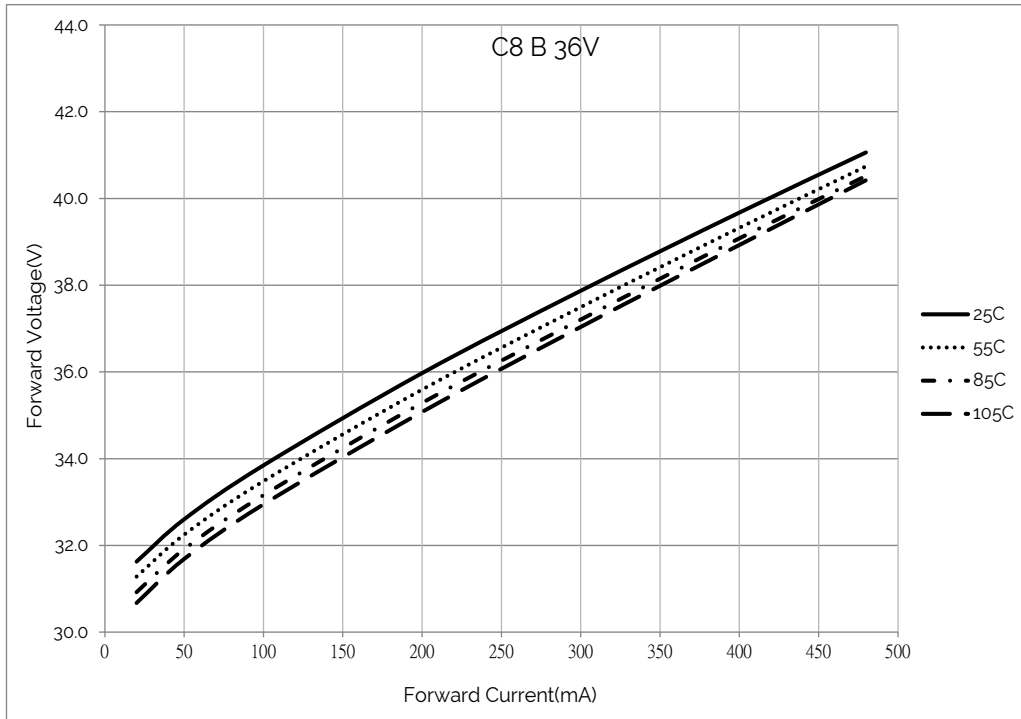
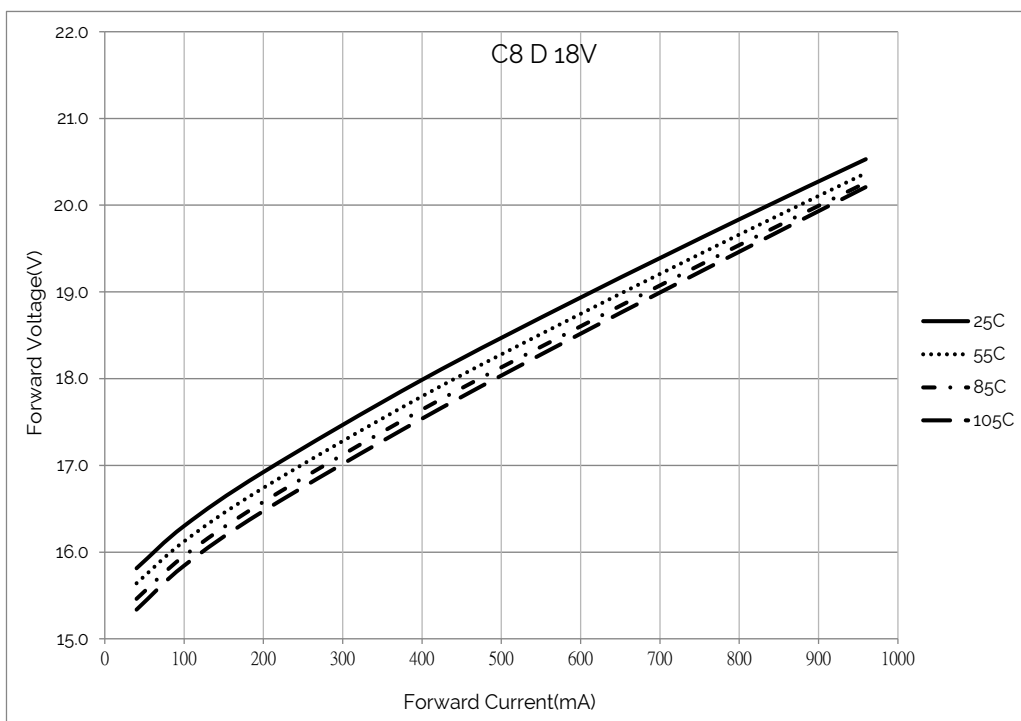

Figure 2: Forward Voltage vs. Forward Current



Performance Curves

Figure 3: Forward Voltage vs. Forward Current

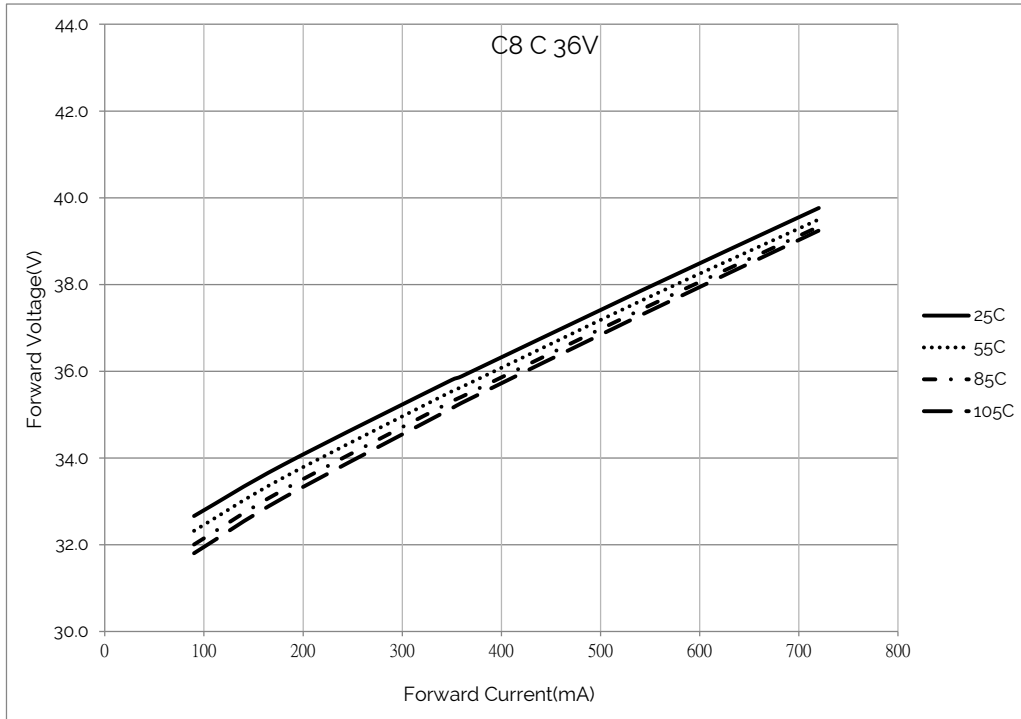
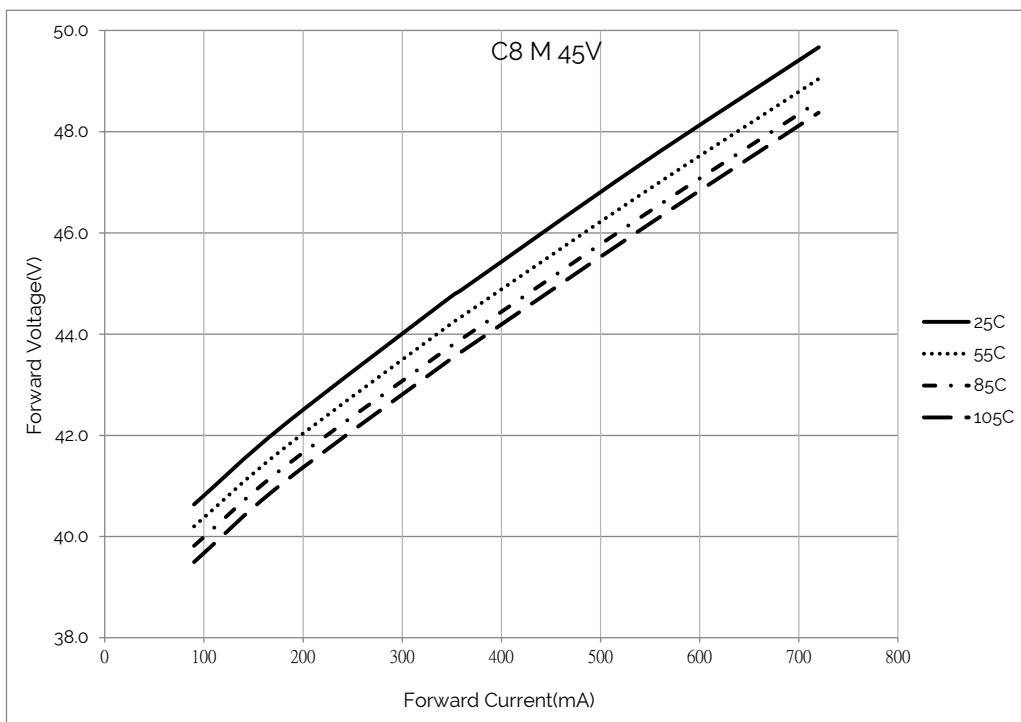

Figure 4: Forward Voltage vs. Forward Current



Performance Curves

Figure 5: Relative Luminous Flux vs. Drive Current

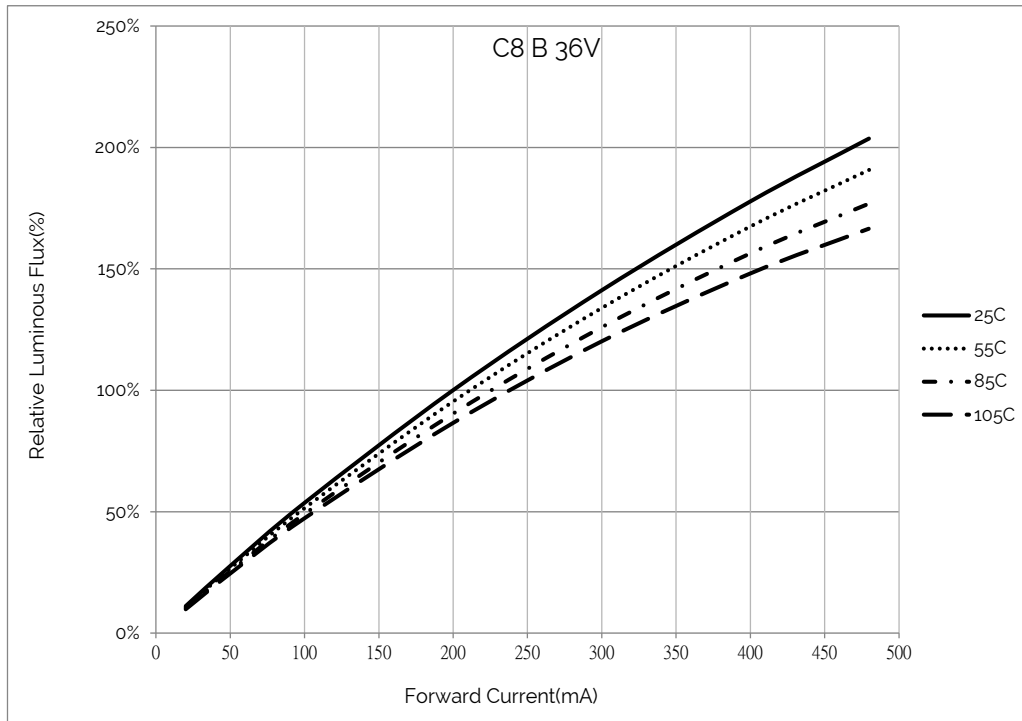
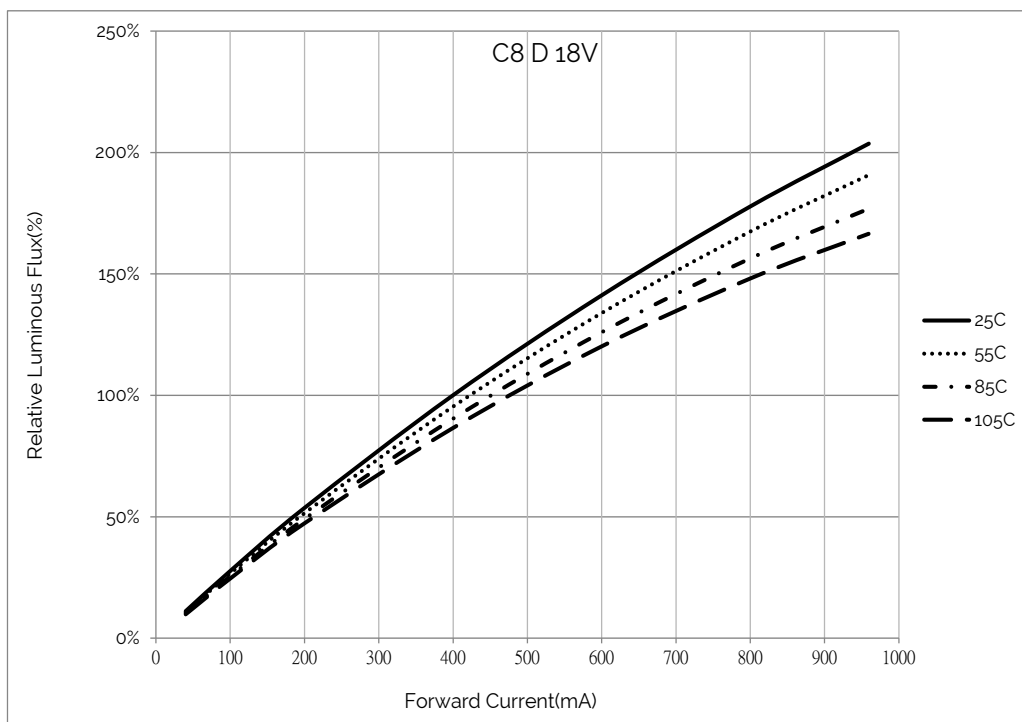

Figure 6: Relative Luminous Flux vs. Drive Current



Performance Curves

Figure 7: Relative Luminous Flux vs. Drive Current

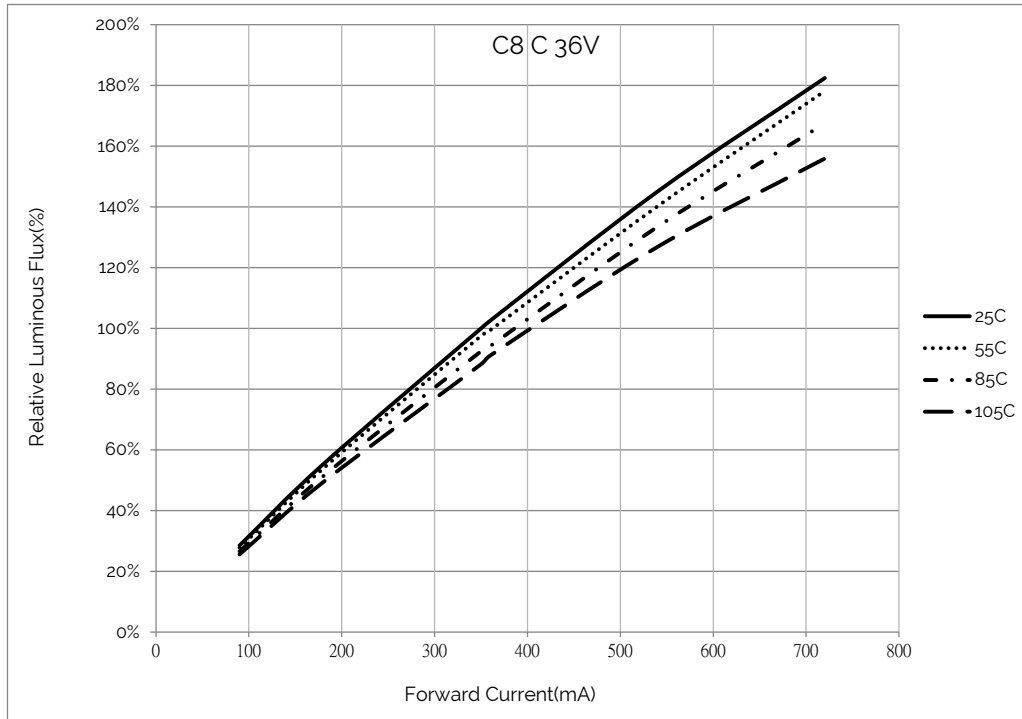
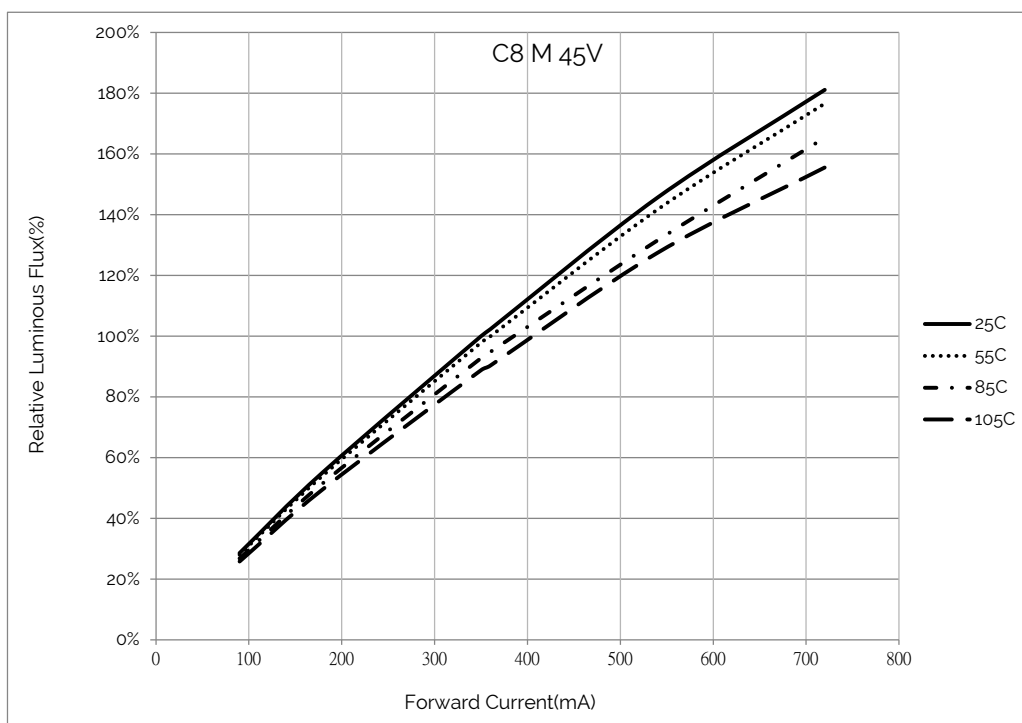

Figure 8: Relative Luminous Flux vs. Drive Current



Notes for Figure 4 to Figure 8:

1. Characteristics shown based on 3000K and 80 CRI.
2. For other color SKUs, the relative luminous will vary. Please contact your Bridgelux sales representative for more information.

Performance Curves

Figure 9: Relative Luminous Flux vs. Case Temperature

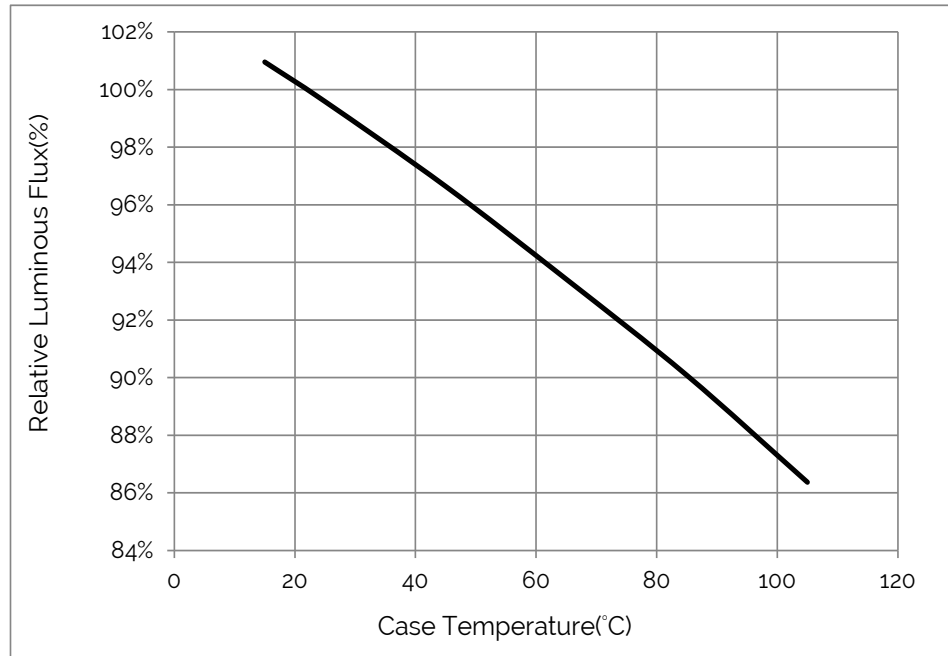

Notes for Figure 9:

1. Characteristics based on 3000K and 80 CRI.
2. For other color SKUs, the relative luminous will vary. Please contact your Bridgelux sales representative for more information.

Figure 10: Relative Voltage vs. Case Temperature

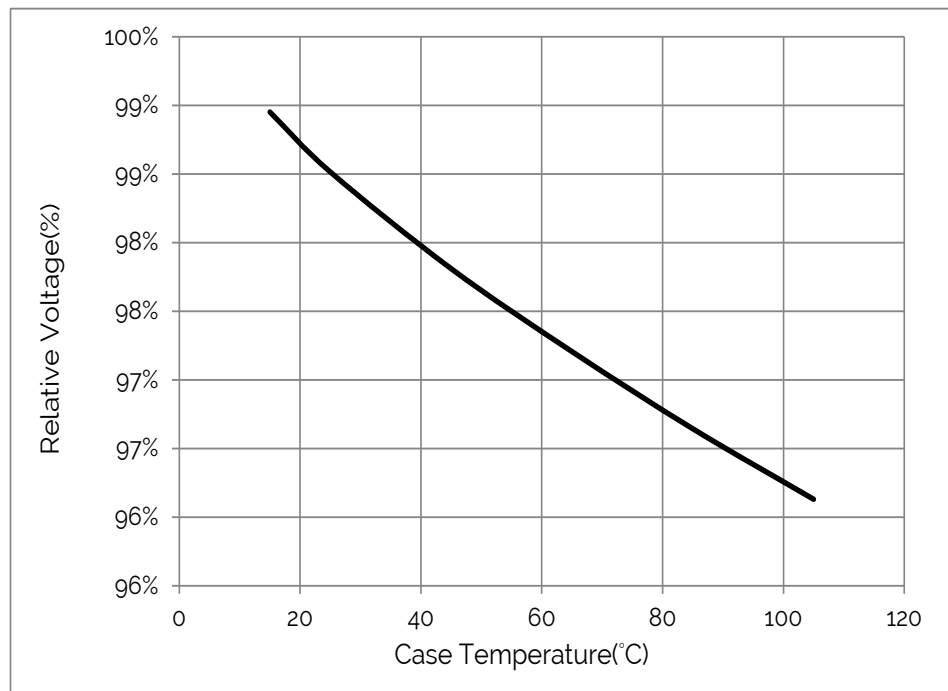

Performance Curves

Figure 11: Typical DC ccx Shift vs. Case Temperature

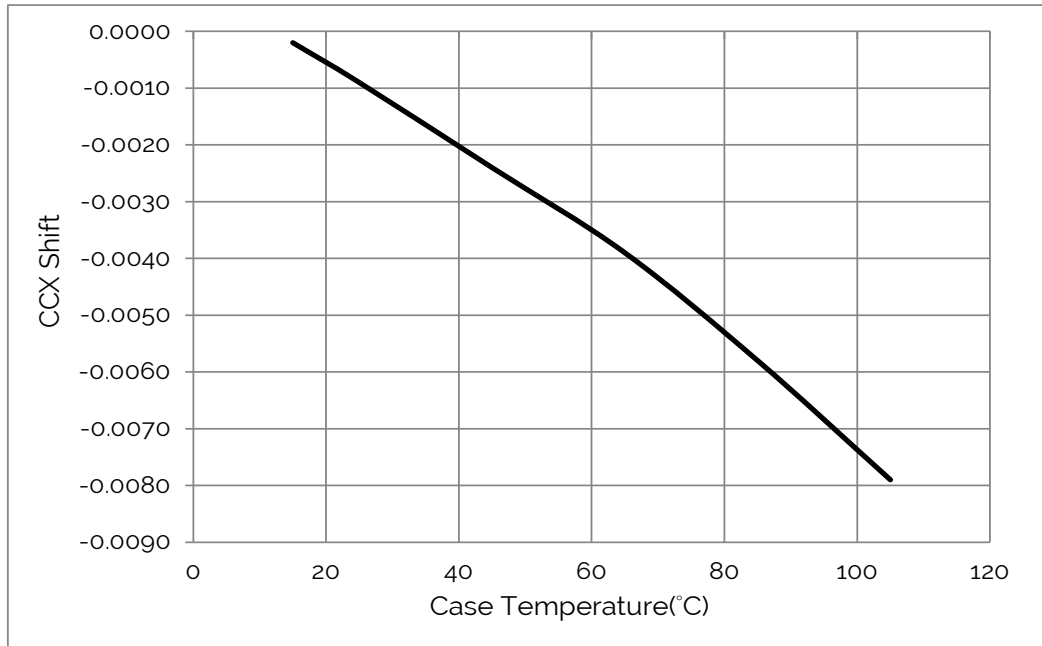
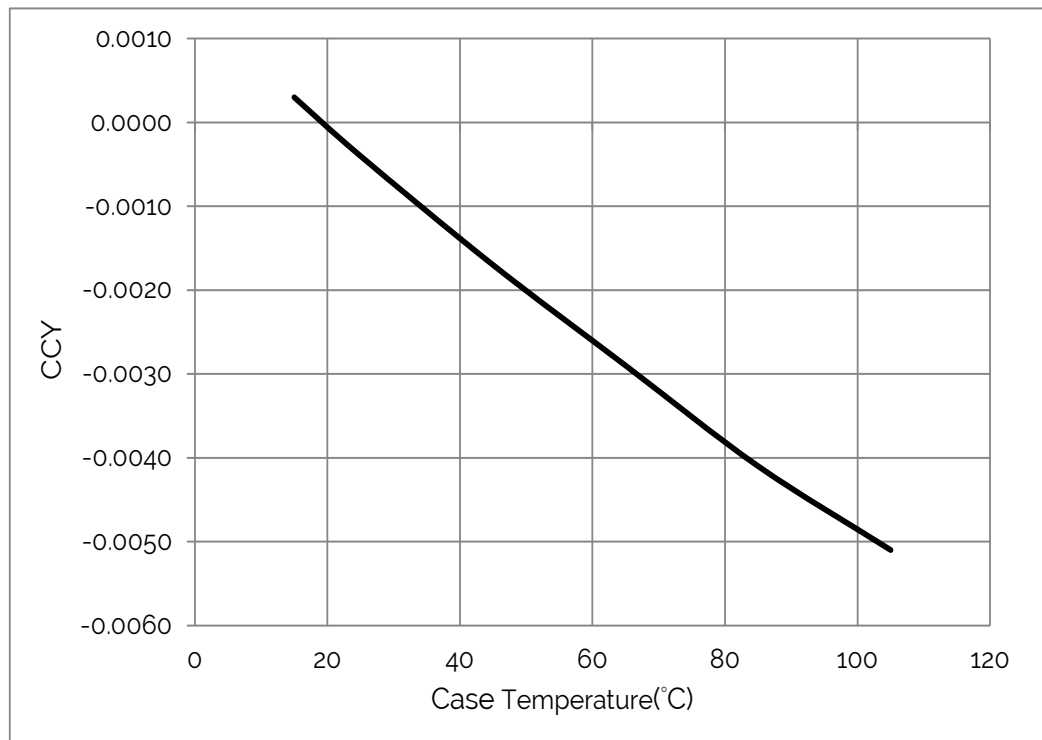

Figure 12: Typical DC ccy Shift vs. Case Temperature



Notes for Figure 9 and Figure 12:

1. Characteristics shown based on 3000K and 80 CRI.
2. For other color SKUs, the shift in color will vary. Please contact your Bridgelux sales representative for more information.

Typical Radiation Pattern

Figure 13: Typical Spatial Radiation Pattern

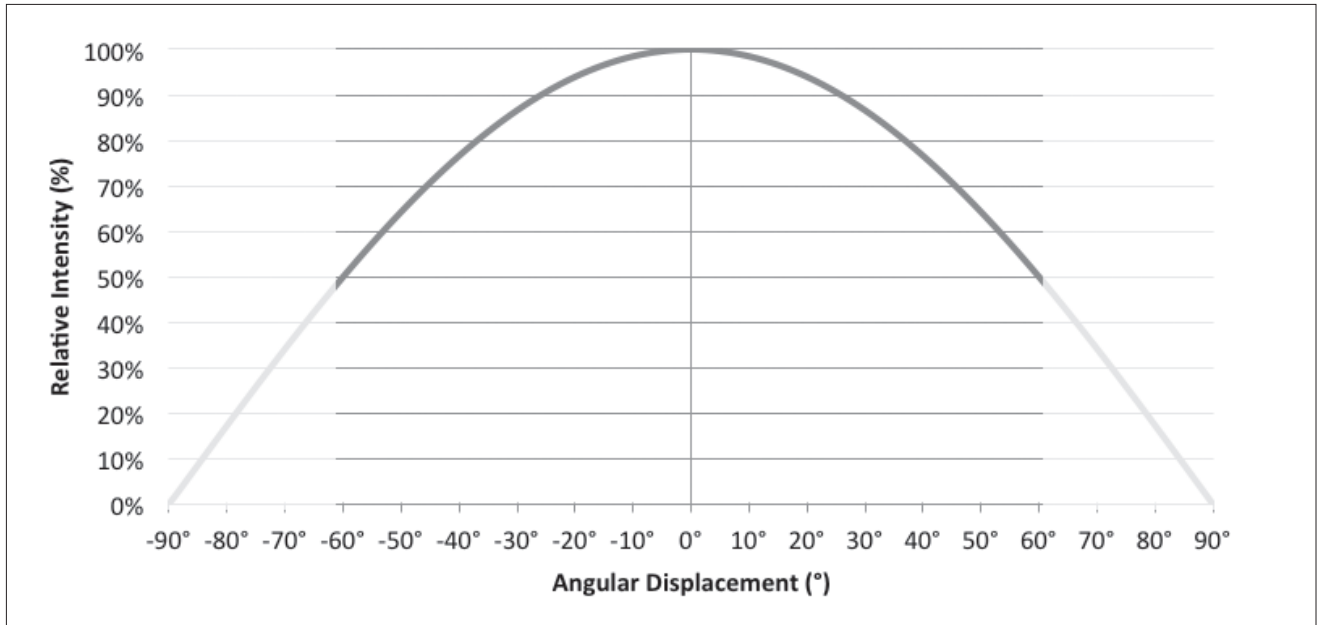

Notes for Figure 13:

1. Typical viewing angle is 120°.
2. The viewing angle is defined as the off axis angle from the centerline where intensity is ½ of the peak value.

Figure 14: Typical Polar Radiation Pattern

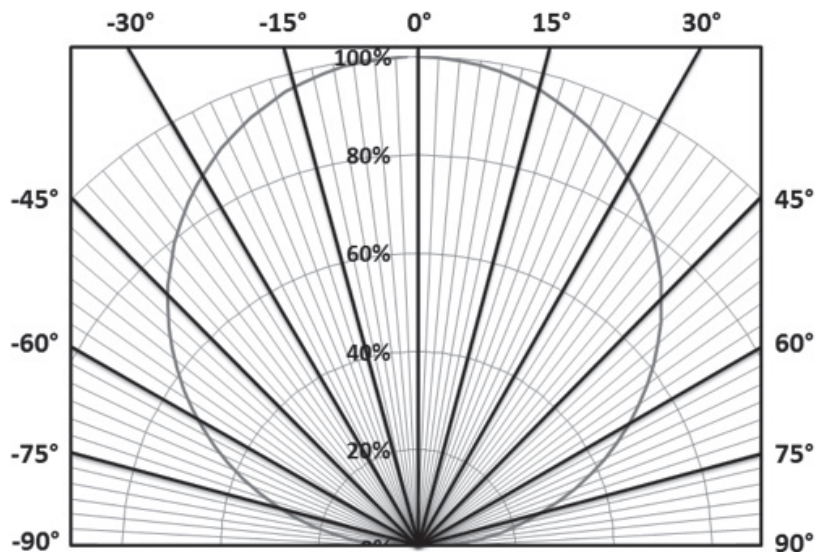

Typical Color Spectrum

Figure 15: Typical Color Spectrum

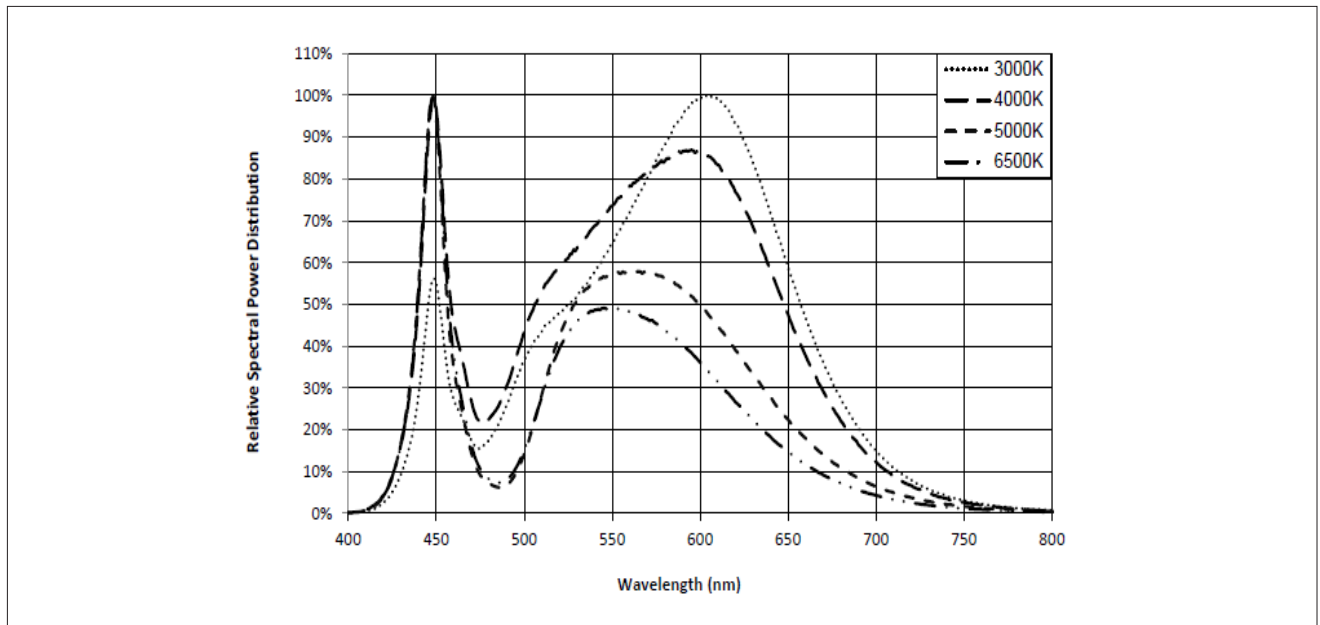

Notes for Figure 15:

1. Color spectra measured at nominal current for $T_J - T_C = 25^\circ\text{C}$.
2. Color spectra shown is 3000K and 80 CRI.
3. Color spectra shown is 4000K and 80 CRI.
4. Color spectra shown is 5000K and 70 CRI.
4. Color spectra shown is 6500K and 70 CRI.

Operating Limits

Figure 16: Operating Limits

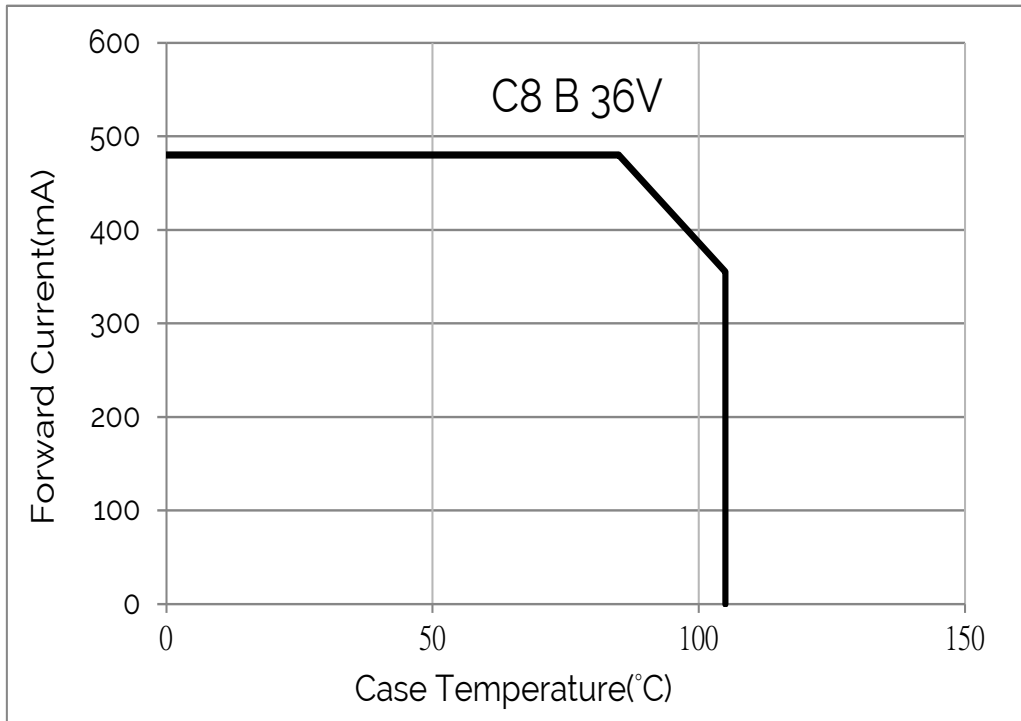
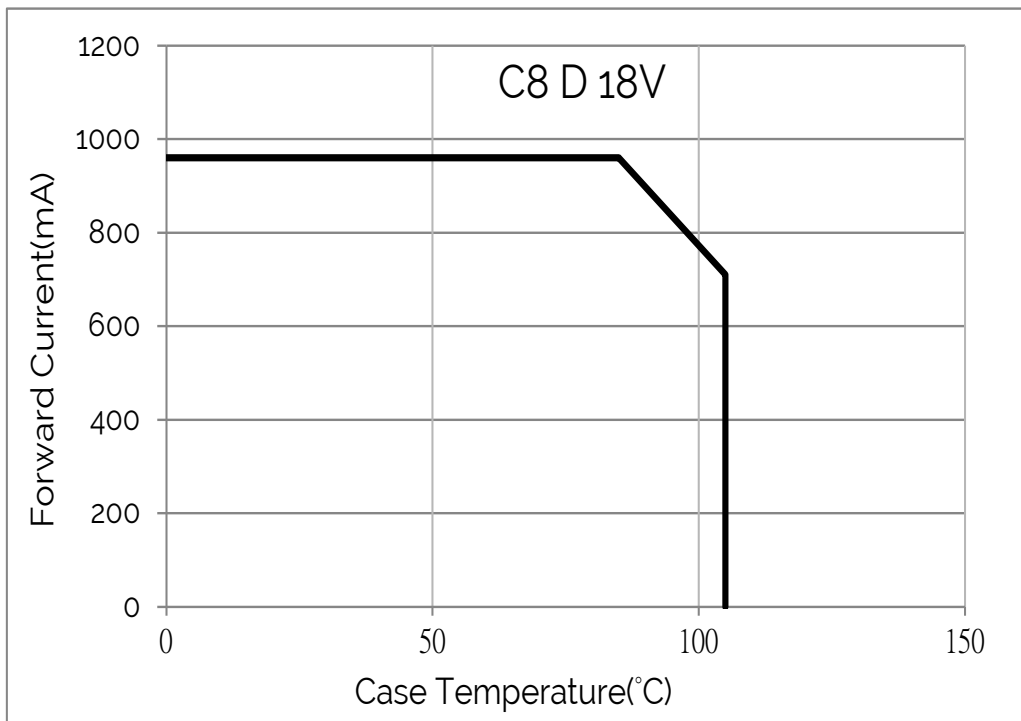

Figure 17: Operating Limits



Operating Limits

Figure 18: Operating Limits

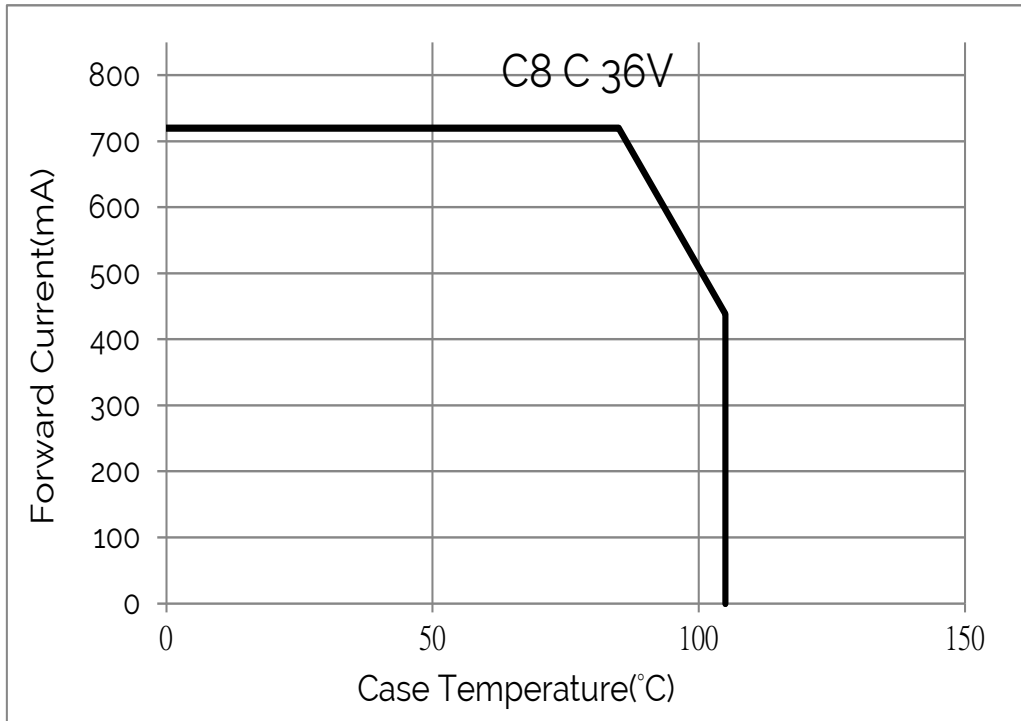
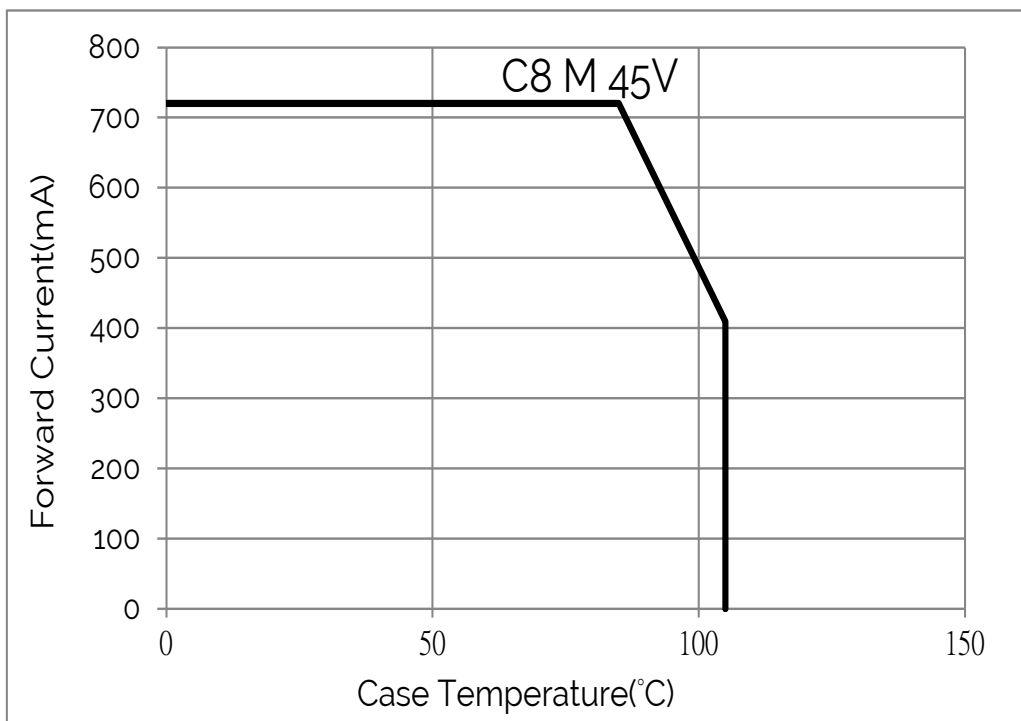

Figure 19: Operating Limits



Color Binning Information

Table 6: xy Bin Coordinates and Associated Typical CCT

CCT	Center Point		Degree	3 step		4 step	
	x	y	(°)	a	b	a	b
2700K	0.4578	0.4101	53.700	0.0081	0.0042	N/A	N/A
3000K	0.4338	0.403	53.217	0.0083	0.0041	N/A	N/A
3500K	0.4073	0.3917	54.000	0.0093	0.0041	N/A	N/A
4000K	0.3818	0.3797	53.717	0.0094	0.0040	N/A	N/A
5000K	0.3447	0.3553	59.617	N/A	N/A	0.0110	0.0047
5600K	0.3287	0.3417	59.060	N/A	N/A	0.0099	0.0042
6500K	0.3123	0.3282	58.567	N/A	N/A	0.0089	0.0038

Notes for Table 6:

1. 2700K \3000K\3500K\4000K product is cold targeted to Tc = 25°C
2. 5000K \5600K\6500K product is hot targeted to Tc = 85°C

Table 7: Warm and Neutral White xy Bin Coordinates and Associated Typical CCT

Bin Code	2700K	3000K	3500K	4000K
13 (3 SDCM)	(2651K - 2794K)	(2968K - 3136K)	(3369K - 3586K)	(3851K - 4130K)
12 (2 SDCM)	(2674K - 2769K)	(2995K - 3107K)	(3404K - 3548K)	(3895K - 4081K)
Center Point (x,y)	(0.4578, 0.4101)	(0.4338, 0.403)1	(0.4073, 0.3917)	(0.3818, 0.3797)

Notes for Table 7:

1. Center Point for Decor Series Showcase.

Color Binning Information

Figure 20: Graph of Test Bins in xy Color Space

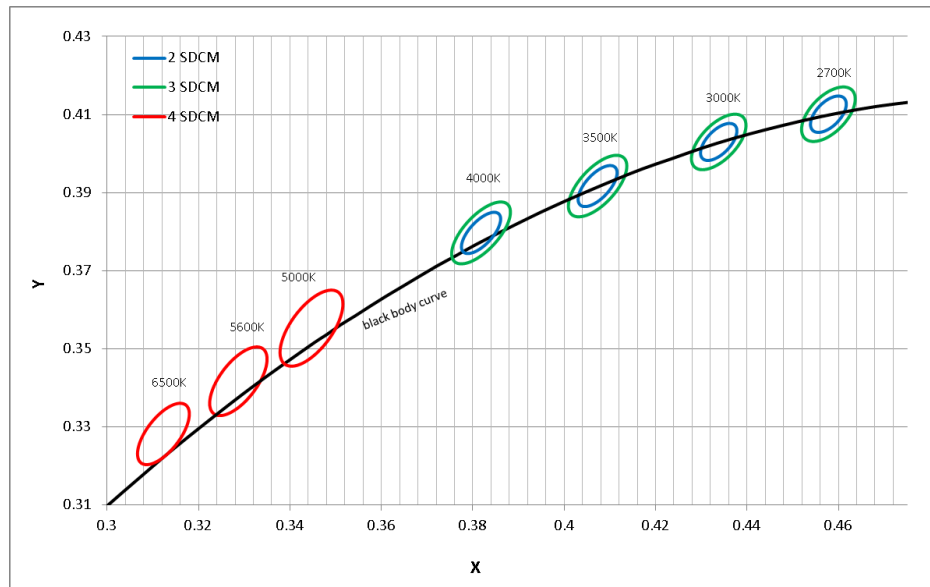

Notes for Figure 20:

1. DC Test Conditions at $T_c = 85^\circ\text{C}$.
2. Bridgelux maintains a tolerance of ± 0.007 on x and y color coordinates in the CIE 1931 color space.

Mechanical Dimensions

Figure 21: Drawing for E8 CA LED Array

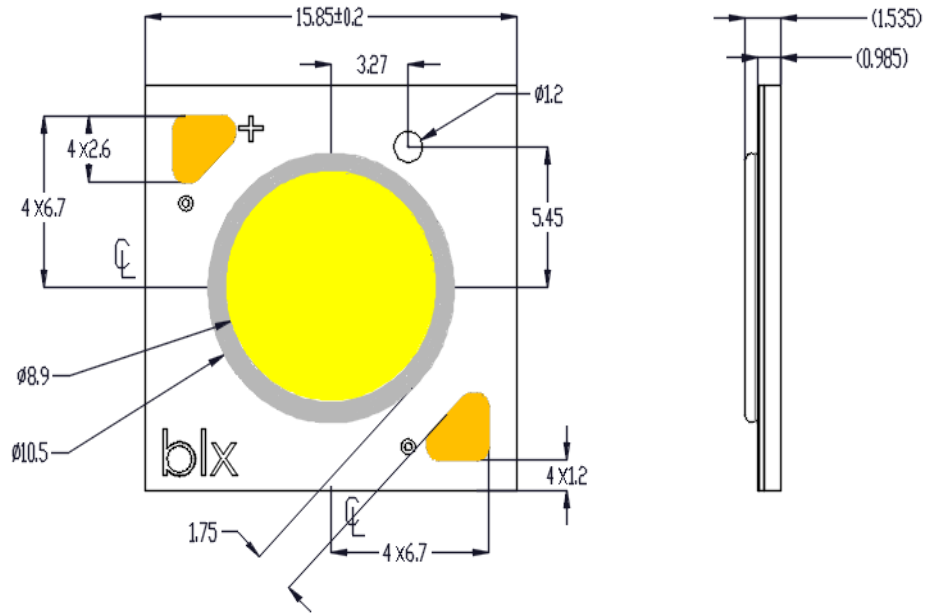

Notes for Figure 21:

1. Bridgelux maintains a flatness of 0.10mm across the mounting surface of the array
2. Drawings are not to scale.
3. Drawing dimensions are in millimeters.
4. Unless otherwise specified, tolerances are ± 0.13 mm.
5. Solder pad labeled "+" denotes positive contact
6. The optical center of the LED Array is nominally defined by the mechanical center of the array to a tolerance of ± 0.2 mm.

Packaging and Labeling

Figure 22: Packaging and Labeling

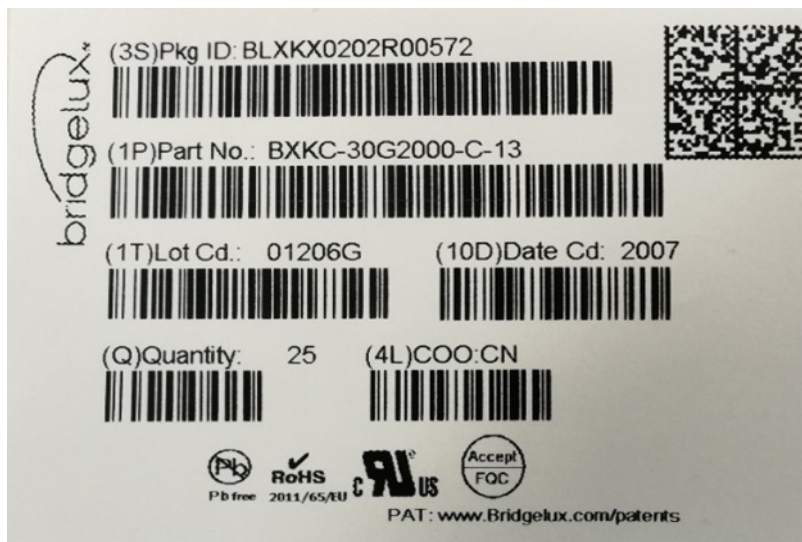

Packaging and Labeling

Figure 23: Laser Marking

Bridgelux COB arrays have laser markings on the back side of the substrate to help with product identification. In addition to the product identification markings, Bridgelux COB arrays also contain markings for internal Bridgelux manufacturing use only. The image below shows which markings are for customer use and which ones are for Bridgelux internal use only. The Bridgelux internal manufacturing markings are subject to change without notice, however these will not impact the form, function or performance of the COB array.



Customer Use- 2D Barcode Scannable barcode provides product part number and other Bridgelux internal production information.

30E1501B 13

Customer Use- Product part number

Design Resources

LM80

LM80 testing has been completed and the LM80 report is now available. Please contact your Bridgelux sales representative for more information.

Precautions

CAUTION: CHEMICAL EXPOSURE HAZARD

Exposure to some chemicals commonly used in luminaire manufacturing and assembly can cause damage to the LED array. Please consult Bridgelux Application Note AN31 for additional information.

CAUTION: EYE SAFETY

The Bridgelux Dual Color LED Array emits visible light, that, under certain circumstances, could be harmful to the eye. Proper safeguards must be used.

CAUTION: RISK OF BURN

Do not touch the Bridgelux Dual Color LED array during operation. Allow the array to cool for a sufficient period of time before handling. The Bridgelux Dual Color LED array may reach elevated temperatures such that could burn skin when touched

CAUTION

CONTACT WITH LIGHT EMITTING SURFACE (LES)

Avoid any contact with the LES. Do not touch the LES of the LED array or apply stress to the LES (yellow phosphor resin area). Contact may cause damage to the LED array.

Optics and reflectors must not be mounted in contact with the LES (yellow phosphor resin area). Use the mechanical features of the LED array housing, edges and/or mounting holes to locate and secure optical devices as needed.

Disclaimers

MINOR PRODUCT CHANGE POLICY

The rigorous qualification testing on products offered by Bridgelux provides performance assurance. Slight cosmetic changes that do not affect form, fit, or function may occur as Bridgelux continues product optimization.

STANDARD TEST CONDITIONS

Unless otherwise stated, array testing is performed at the nominal drive current.

About Bridgelux: Bridging Light and Life™

At Bridgelux, we help companies, industries and people experience the power and possibility of light. Since 2002, we've designed LED solutions that are high performing, energy efficient, cost effective and easy to integrate. Our focus is on light's impact on human behavior, delivering products that create better environments, experiences and returns—both experiential and financial. And our patented technology drives new platforms for commercial and industrial luminaires.

For more information about the company, please visit
bridgelux.com
twitter.com/Bridgelux
facebook.com/Bridgelux
youtube.com/user/Bridgelux
linkedin.com/company/bridgelux-inc-_2
WeChat ID: BridgeluxInChina



46430 Fremont Boulevard
Fremont, CA 94538 USA
Tel (925) 583-8400
Fax (925) 583-8401
www.bridgelux.com

© 2019 Bridgelux, Inc. All rights reserved. Product specifications are subject to change without notice. Bridgelux and the Bridgelux stylized logo design are registered trademarks of Bridgelux, Inc. All other trademarks are the property of their respective owners.