

# Bridgelux® SMD 2835 0.5W 3V Thrive™

Product Data Sheet DS312

# Introduction

SMD 2835 Thrive



## Features

- Engineered spectra to closely match natural light
- CRI > 95, R1-R15 >90, high Rf and Rg values
- High efficiency full spectrum solution
- No violet chip augmentation
- Hot color targeted
- Industry standard 2835 footprint
- Broad product platform availability (SMDs and COBs)

## Benefits

- Full consistent spectrum with fewer spectral spikes
- Natural and vivid color rendering
- Greater energy savings, lower utility costs
- Economical, high efficiency solution
- Uniform and consistent white light under application conditions
- Ease of design and rapid go-to-market
- Enables greater design flexibility and platform color consistency



# Contents

Product Feature Map	2
Product Nomenclature	2
Product Selection Guide	3
Spectrum Characteristics	4
Electrical Characteristics	7
Absolute Maximum Ratings	8
Product Bin Definitions	9
Performance Curves	12
Typical Radiation Pattern	13
Mechanical Dimensions	14
Reliability	15
Reflow Characteristics	16
Packaging	17
Design Resources	19
Precautions	19
Disclaimers	19
About Bridgelux	20

# Product Feature Map

Bridgelux SMD LED products come in industry standard package sizes and follow ANSI binning standards. These LEDs are optimized for cost and performance, helping to ensure highly competitive system lumen per dollar performance while addressing the stringent efficacy and reliability standards required for modern lighting applications.

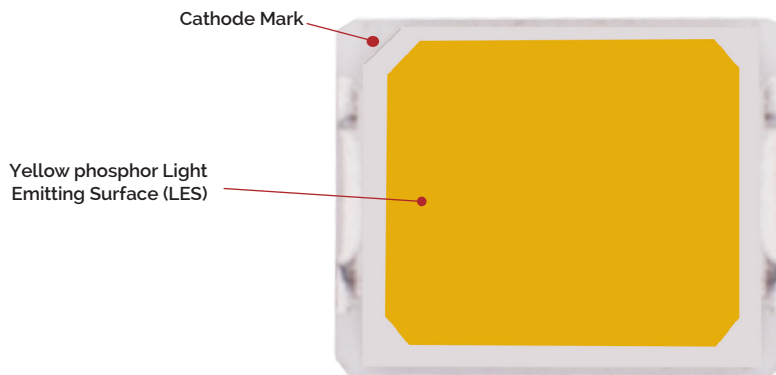

## Product Nomenclature

The part number designation for Bridgelux SMD 2835 is explained as follows:

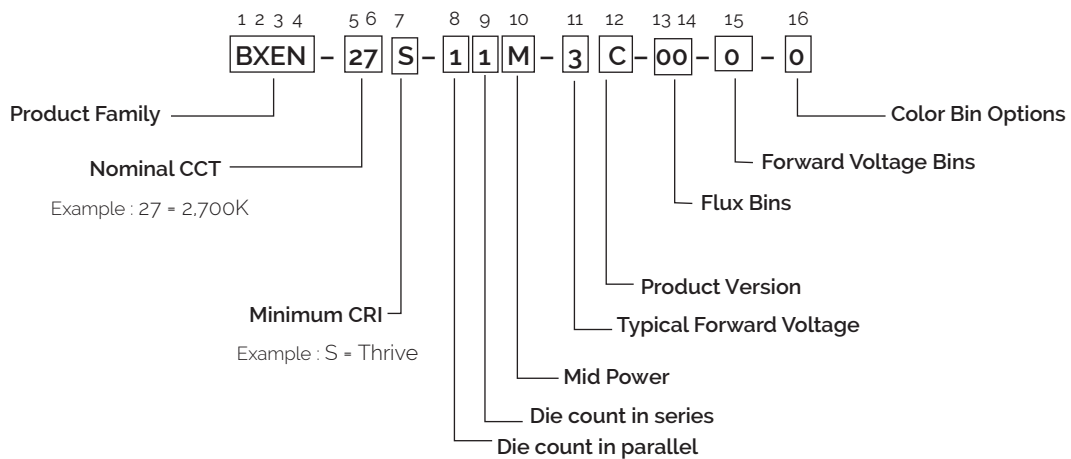

# Product Selection Guide

The following product configurations are available:

**Table 1:** Selection Guide, Pulsed Measurement Data at 150mA ( $T_{sp} = 25^{\circ}\text{C}$ )

Part Number <sup>1,6</sup>	Nominal CCT <sup>2</sup> (K)	CRI <sup>3,5</sup> (Typical)	Nominal Drive Current (mA)	Forward Voltage <sup>4,5</sup> (V)			Typical Pulsed Flux (lm) <sup>4,5</sup>			Typical Power (W)	Typical Efficacy (lm/W)
				Min	Typical	Max	Min	Typical	Max		
BXEN-27S-11M-3C-00-0-0	2700	-	150	2.90	3.13	3.30	45	51	55	0.5	109
BXEN-30S-11M-3C-00-0-0	3000	-	150	2.90	3.13	3.30	45	53	55	0.5	113
BXEN-35S-11M-3C-00-0-0	3500	-	150	2.90	3.13	3.30	45	53	55	0.5	113
BXEN-40S-11M-3C-00-0-0	4000	-	150	2.90	3.13	3.30	50	56	65	0.5	119
BXEN-50S-11M-3C-00-0-0	5000	-	150	2.90	3.13	3.30	50	56	65	0.5	119
BXEN-57S-11M-3C-00-0-0	5700	-	150	2.90	3.13	3.30	50	56	65	0.5	119
BXEN-65S-11M-3C-00-0-0	6500	-	150	2.90	3.13	3.30	50	56	65	0.5	119

**Table 2:** Selection Guide, Pulsed Test Performance at 150mA ( $T_{sp} = 85^{\circ}\text{C}$ )<sup>7,8</sup>

Part Number <sup>1,6</sup>	Nominal CCT <sup>2</sup> (K)	CRI <sup>3,5</sup> (Typical)	Nominal Drive Current (mA)	Forward Voltage <sup>5</sup> (V)			Typical Pulsed Flux (lm) <sup>5</sup>			Typical Power (W)	Typical Efficacy (lm/W)
				Min	Typical	Max	Min	Typical	Max		
BXEN-27S-11M-3C-00-0-0	2700	97	150	2.84	3.07	3.24	39.2	44.5	47.9	0.5	97
BXEN-30S-11M-3C-00-0-0	3000	97	150	2.84	3.07	3.24	39.2	46.2	47.9	0.5	100
BXEN-35S-11M-3C-00-0-0	3500	97	150	2.84	3.07	3.24	39.2	46.2	47.9	0.5	100
BXEN-40S-11M-3C-00-0-0	4000	97	150	2.84	3.07	3.24	43.6	48.8	52.3	0.5	106
BXEN-50S-11M-3C-00-0-0	5000	97	150	2.84	3.07	3.24	43.6	48.8	56.7	0.5	106
BXEN-57S-11M-3C-00-0-0	5700	97	150	2.84	3.07	3.24	43.6	48.8	56.7	0.5	106
BXEN-65S-11M-3C-00-0-0	6500	97	150	2.84	3.07	3.24	43.6	48.8	56.7	0.5	106

Notes for Tables 1 & 2:

- The last 6 characters (including hyphens '-') refer to flux bins, forward voltage bins, and color bin options, respectively. "00-0-0" denotes the full distribution of flux, forward voltage, and color bin.  
Example: BXEN-27S-11M-3C-00-0-0 refers to the full distribution of flux, forward voltage, and color within a 2700K 6-step ANSI standard chromaticity region with a minimum of 95 CRI, 1x1 die configuration, mid power, 3.13V typical forward voltage.
- Product CCT is hot targeted at  $T_{sp} = 85^{\circ}\text{C}$ . Nominal CCT as defined by ANSI C78.377-2011.
- Listed CRIs are typical values and include test tolerance.
- Products tested under pulsed condition (10ms pulse width) at nominal drive current
- Bridgelux maintains a  $\pm 7.5\%$  tolerance on luminous flux measurements,  $\pm 0.15\text{V}$  tolerance on forward voltage measurements, and  $\pm 3$  tolerance on CRI measurements for the SMD 2835.
- Refer to Table 6 and Table 7 for Bridgelux SMD 2835 Luminous Flux Binning and Forward Voltage Binning information.
- Typical pulsed test performance values are provided as reference only and are not a guarantee of performance.
- Typical performance is estimated based on operation under pulsed current with LED emitter mounted onto a heat sink with thermal interface material and the solder point temperature maintained at  $85^{\circ}\text{C}$ . Based on Bridgelux test setup, values may vary depending on the thermal design of the luminaire and the exposed environment to which the product is subjected.

# Spectrum Characteristics

**Table 3:** Typical Color Rendering Index and TM-30 Values, 150mA,  $T_{sp}=55^{\circ}\text{C}$  <sup>1</sup>

Nominal CCT <sup>1</sup>	R <sub>f</sub>	R <sub>g</sub>	R <sub>1</sub>	R <sub>2</sub>	R <sub>3</sub>	R <sub>4</sub>	R <sub>5</sub>	R <sub>6</sub>	R <sub>7</sub>	R <sub>8</sub>	R <sub>9</sub>	R <sub>10</sub>	R <sub>11</sub>	R <sub>12</sub>	R <sub>13</sub>	R <sub>14</sub>	R <sub>15</sub>
2700K	95	100	96	97	97	95	96	96	99	98	95	98	91	92	96	98	99
3000K	96	99	97	99	97	96	97	97	98	98	94	97	98	94	98	99	98
4000K	95	99	97	97	99	97	97	97	97	97	95	96	97	93	97	98	98
5000K	96	100	97	97	98	97	97	96	97	98	96	94	97	95	97	99	99
5700K	96	100	99	97	94	95	98	96	98	96	96	92	96	95	98	96	99
6500K	96	99	98	99	99	99	99	98	99	98	94	98	99	94	98	99	99

Note for Table 3:

1. Bridgelux maintains a tolerance of  $\pm 3$  on Color Rendering Index R1-R15 measurements and TM-30 measurements.
2. R values will vary depending on the drive current

**Figure 1: Typical Color Spectrum**

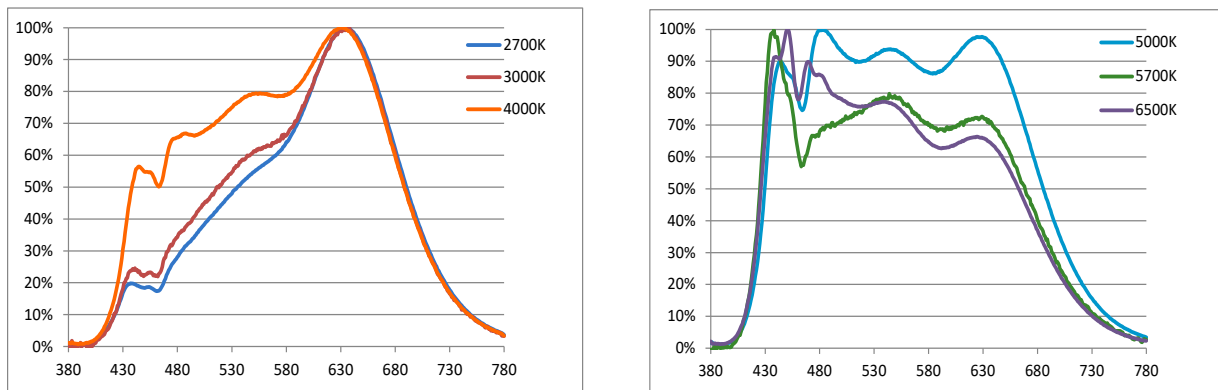

Note for Figure 1:

1. Color spectra measured reference by nominal current for  $T_{sp} = 55^{\circ}\text{C}$ .

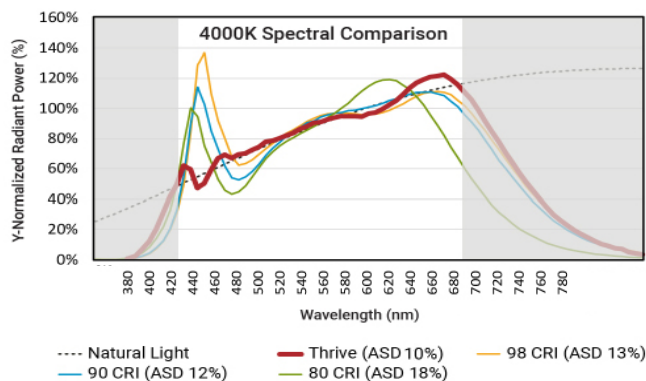

## Spectral Matching to Natural Light

Humans have evolved and thrived for millions of years under the sun's natural daylight. While discussions continue regarding the development of LED products with artificial spectra aimed at increasing productivity and focus or helping with relaxation, the long-term physiological effects of such altered environments on humans remains unknown.

Bridgelux Thrive is engineered to provide the closest match to natural light using proprietary chip, phosphor and packaging technology. Bridgelux is working with our customers and industry partners to define new metrics to describe and quantify this spectral matching; going beyond today's quality of light metrics such as CRI and TM-30.

# Spectrum Characteristics

Figure 2: 2700K Thrive TM-30 Graphs

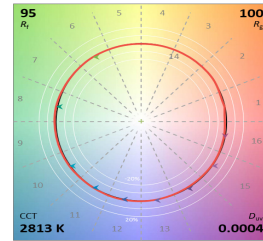
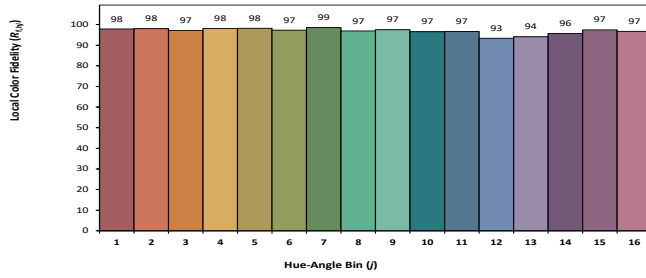

Figure 3: 3000K Thrive TM-30 Graphs

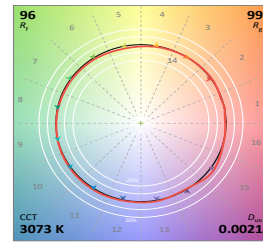
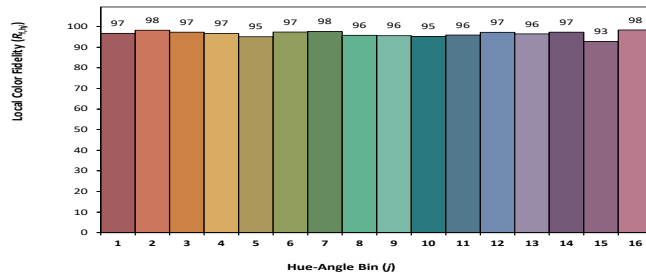

Figure 4: 4000K Thrive TM-30 Graphs

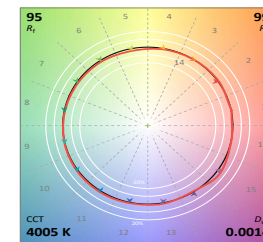
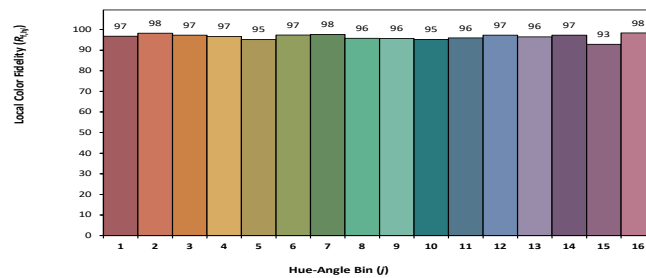
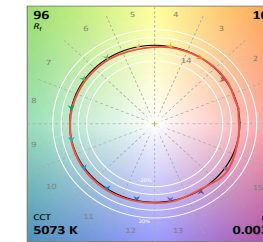
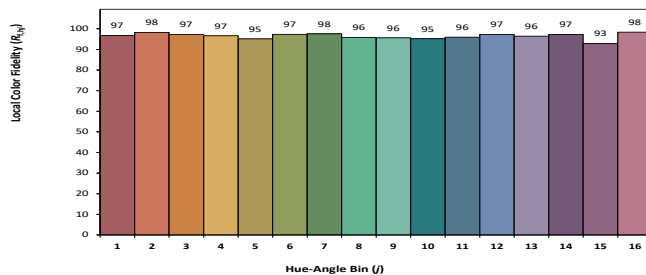

Figure 5: 5000K Thrive TM-30 Graphs



# Spectrum Characteristics

Figure 6: 5700K Thrive TM-30 Graphs

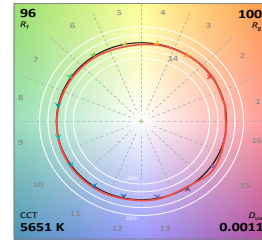
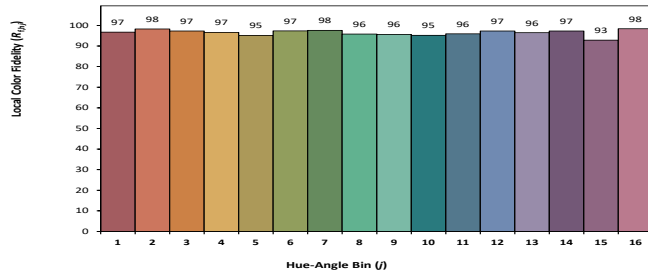
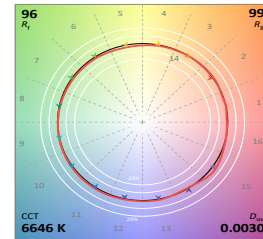
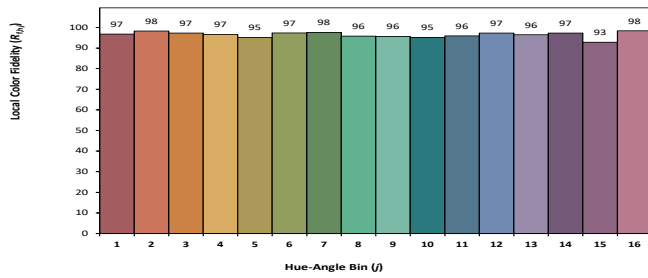

Figure 7: 6500K Thrive TM-30 Graphs





# Electrical Characteristics

**Table 4:** Electrical Characteristics

Part Number <sup>1</sup>	Drive Current (mA)	Forward Voltage (V) <sup>2,3</sup>			Typical Temperature Coefficient of Forward Voltage $\Delta V_f / \Delta T$ (mV/°C)	Typical Thermal Resistance Junction to Solder Point <sup>3</sup> $R_{j-sp}$ (°C/W)
		Minimum	Typical	Maximum		
BXEN-XXX-11M-3C-00-0-0	150	2.90	3.13	3.30	-1.04	31

Notes for Table 4:

1. Bridgelux maintains a tolerance of  $\pm 0.15V$  on forward voltage measurements. Voltage minimum and maximum values at the nominal drive current are guaranteed by 100% test.
2. Products tested under pulsed condition (10ms pulse width) at nominal drive current where  $T_{sp} = 25^{\circ}C$ .
3. Thermal resistance value was calculated using total electrical input power; optical power was not subtracted from input power.

# Absolute Maximum Ratings

**Table 5:** Maximum Ratings

Parameter	Maximum Rating
LED Junction Temperature ( $T_j$ )	125°C
Storage Temperature	-40°C to +105°C
Operating Solder Point Temperature ( $T_{sp}$ )	-40°C to +105°C
Soldering Temperature	260°C or lower for a maximum of 10 seconds
Maximum Drive Current	150mA
Maximum Peak Pulsed Forward Current <sup>1</sup>	300mA
Maximum Reverse Voltage <sup>2</sup>	-
Moisture Sensitivity Rating	MSL 3
Electrostatic Discharge	2kV HBM. JEDEC-JS-001-HBM and JEDEC-JS-001-2012

Notes for Table 5:

1. Bridgelux recommends a maximum duty cycle of 10% and pulse width of 10 ms when operating LED SMD at maximum peak pulsed current specified. Maximum peak pulsed current indicate values where LED SMD can be driven without catastrophic failures.
2. Light emitting diodes are not designed to be driven in reverse voltage and will not produce light under this condition. no rating is provided.

# Product Bin Definitions

Table 6 lists the standard photometric luminous flux bins for Bridgelux SMD 2835 LEDs. Although several bins are listed, product availability in a particular bin varies by production run and by product performance. Not all bins are available in all CCTs.

**Table 6:** Luminous Flux Bin Definitions at 150mA,  $T_{sp}=25^{\circ}\text{C}$

Bin Code	Minimum	Maximum	Unit	Condition
29	45	50	lm	$I_F=150\text{mA}$
2A	50	55		
2B	55	60		
22	60	65		

Note for Table 6:

1. Bridgelux maintains a tolerance of  $\pm 7.5\%$  on luminous flux measurements

**Table 7:** Forward Voltage Bin Definition at 150mA,  $T_{sp}=25^{\circ}\text{C}$

Bin Code	Minimum	Maximum	Unit	Condition
B	2.9	3.0	V	$I_F=150\text{mA}$
C	3.0	3.1		
D	3.1	3.2		
E	3.2	3.3		

Note for Table 7:

1. Bridgelux maintains a tolerance of  $\pm 0.1\text{V}$  on forward voltage measurements.

# Product Bin Definitions

**Table 8:** MacAdam Ellipse Color Bin Definitions

CCT	Color Space	Center Point		Major Axis	Minor Axis	Ellipse Rotation Angle	Color Bin
		X	Y				
2700K	3 SDCM	0.4583	0.4124	0.0081	0.0042	53.70	1
	6 SDCM	0.4583	0.4124	0.0162	0.0084	53.70	1/A/B/C/D
3000K	3 SDCM	0.4345	0.4052	0.00834	0.00408	53.22	1
	6 SDCM	0.4345	0.4052	0.01668	0.00816	53.22	1/A/B/C/D
3500K	3 SDCM	0.4080	0.3951	0.00927	0.00414	54.00	1
	6 SDCM	0.4080	0.3951	0.01854	0.00828	54.00	1/A/B/C/D
4000K	3 SDCM	0.3825	0.3825	0.00939	0.00402	53.72	1
	6 SDCM	0.3825	0.3825	0.01878	0.00804	53.72	1/A/B/C/D
5000K	3 SDCM	0.3461	0.3594	0.00822	0.00354	59.62	1
	6 SDCM	0.3461	0.3594	0.01644	0.00708	59.62	1/A/B/C/D
5700K	3 SDCM	0.3302	0.3448	0.00746	0.0032	59.09	1
	6 SDCM	0.3302	0.3448	0.01492	0.0064	59.09	1/A/B/C/D
6500K	3 SDCM	0.3146	0.3330	0.00669	0.00285	58.57	1
	6 SDCM	0.3146	0.3330	0.01338	0.0057	58.57	1/A/B/C/D

Notes for Table 8:

1. Color binning at  $T_{sp} = 55^{\circ}\text{C}$  unless otherwise specified
2. Bridgelux maintains a tolerance of  $\pm 0.007$  on x and y color coordinates in the CIE 1931 color space.

# Product Bin Definitions

Figure 8: C.I.E. 1931 Chromaticity Diagram (Color Targeted at  $T_{sp}=55^{\circ}\text{C}$ )

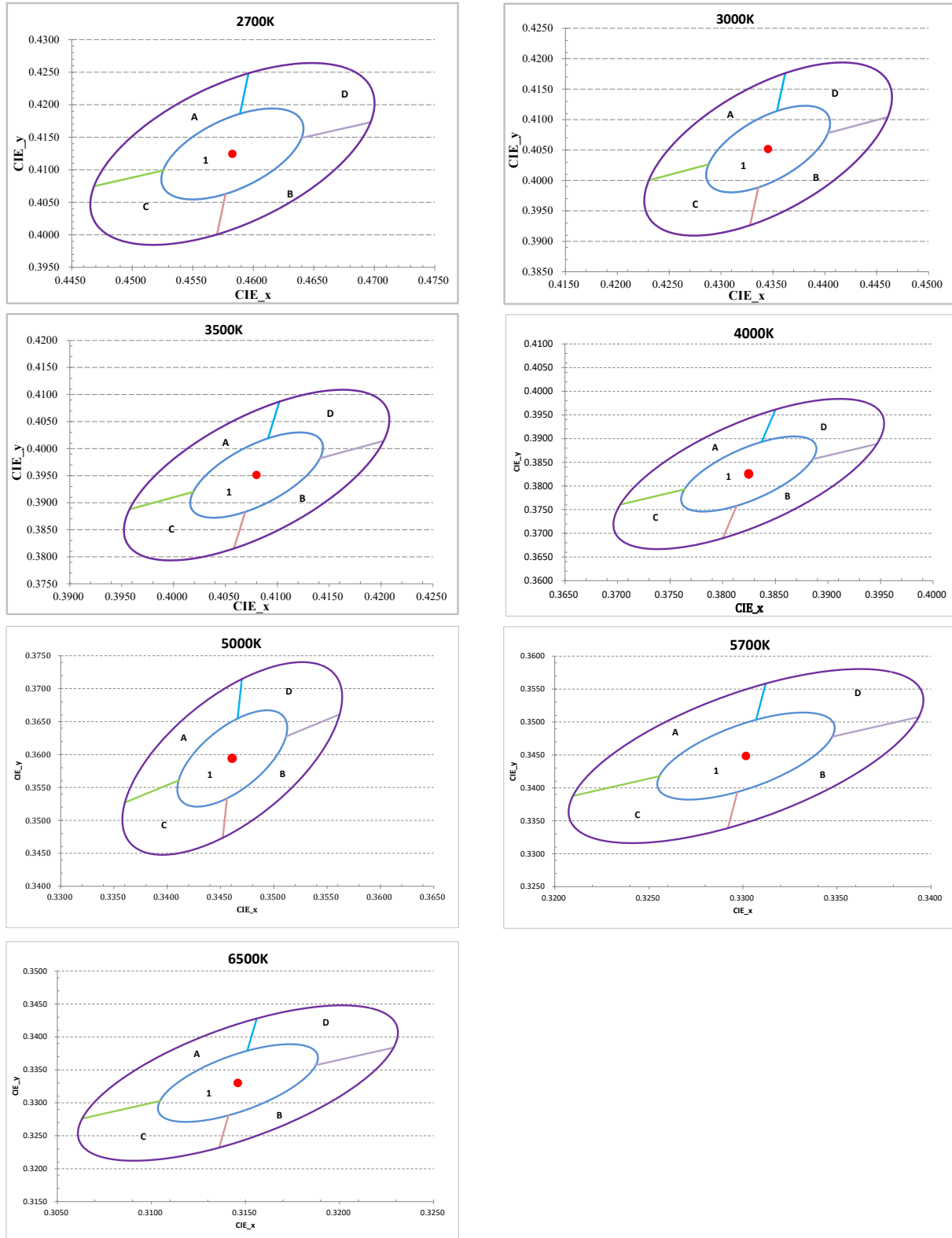

# Performance Curves

**Figure 9: Drive Current vs. Forward Voltage ( $T_{sp} = 25^{\circ}\text{C}$ )**

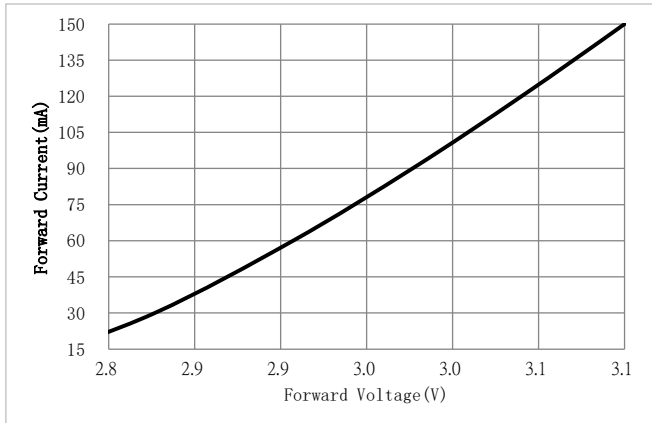

**Figure 10: Typical Relative Luminous Flux vs. Forward Current ( $T_{sp} = 25^{\circ}\text{C}$ )<sup>4</sup>**

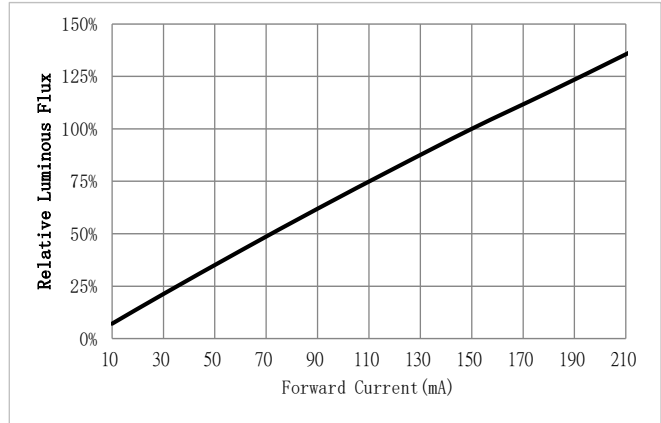

**Figure 11: Typical Relative Flux vs. Solder Point Temperature<sup>2,3,4,5</sup>**

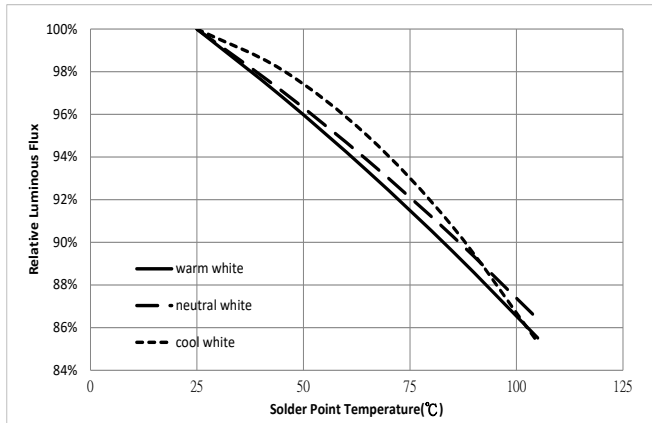

**Figure 12: Typical ccx Shift vs. Solder Point Temperature<sup>2,3,4,5</sup>**

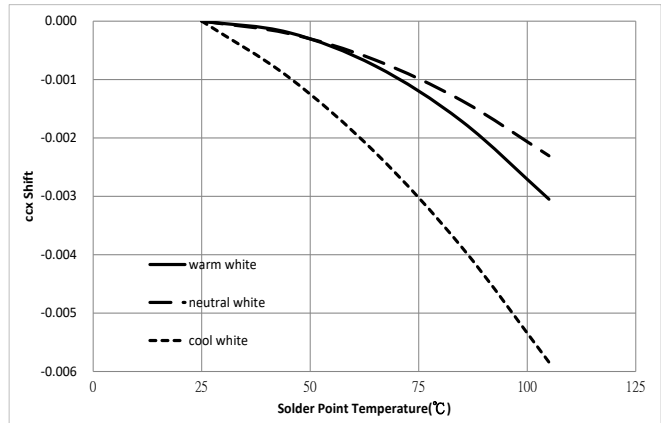

**Figure 13: Typical ccy Shift vs. Solder Point Temperature<sup>2,3,4,5</sup>**

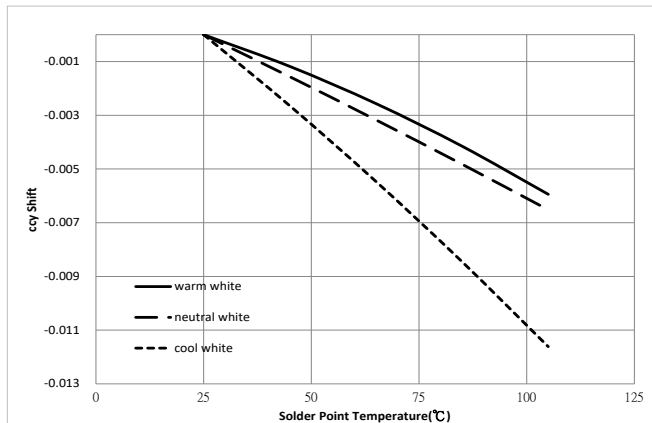

Note for Figures 9-13:

1. Pulse width modulation (PWM) is recommended for dimming effects.
2. Characteristics shown for warm white based on 2700K.
3. Characteristics shown for neutral white based on 4000K.
4. Characteristics shown for cool white based on 6500K.
5. For other color SKUs, the shift in color will vary. Please contact your Bridgelux Sales Representative for more information.

# Typical Radiation Pattern

**Figure 14: Typical Spatial Radiation Pattern at 150mA,  $T_{sp}=25^{\circ}\text{C}$**

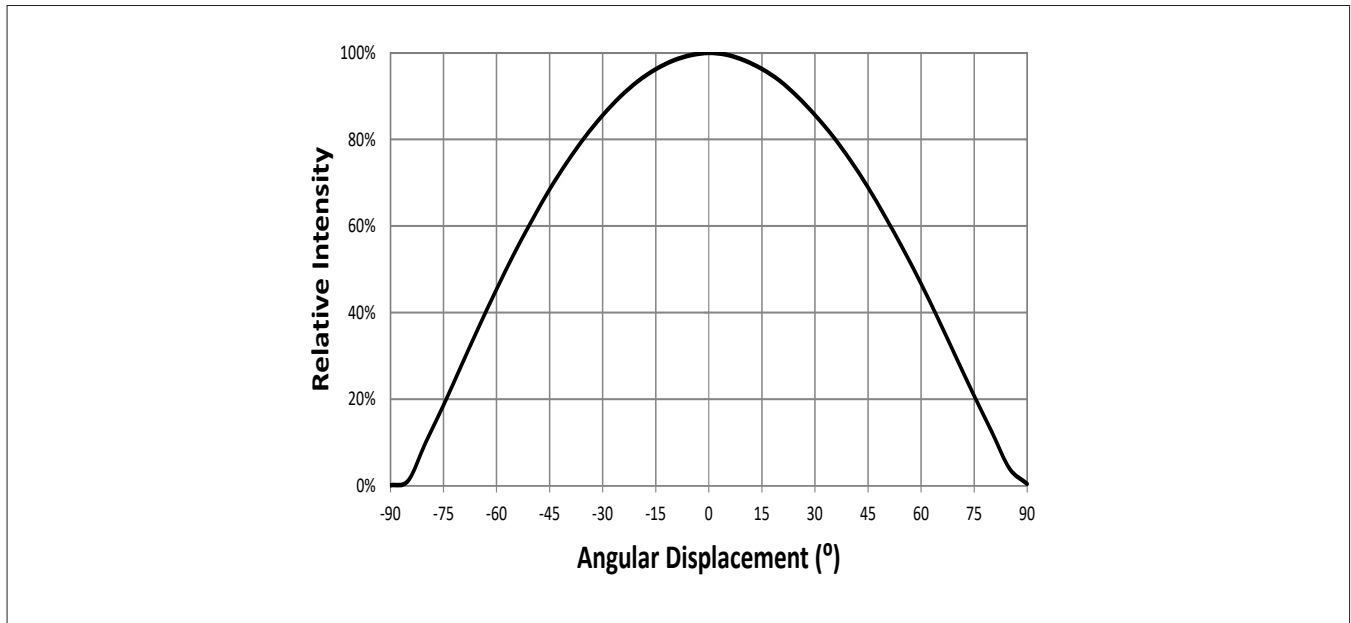

Notes for Figure 14:

1. Typical viewing angle is  $120^{\circ}$ .
2. The viewing angle is defined as the off axis angle from the centerline where luminous intensity (Iv) is  $\frac{1}{2}$  of the peak value.

**Figure 15: Typical Polar Radiation Pattern at 150mA,  $T_{sp}=25^{\circ}\text{C}$**

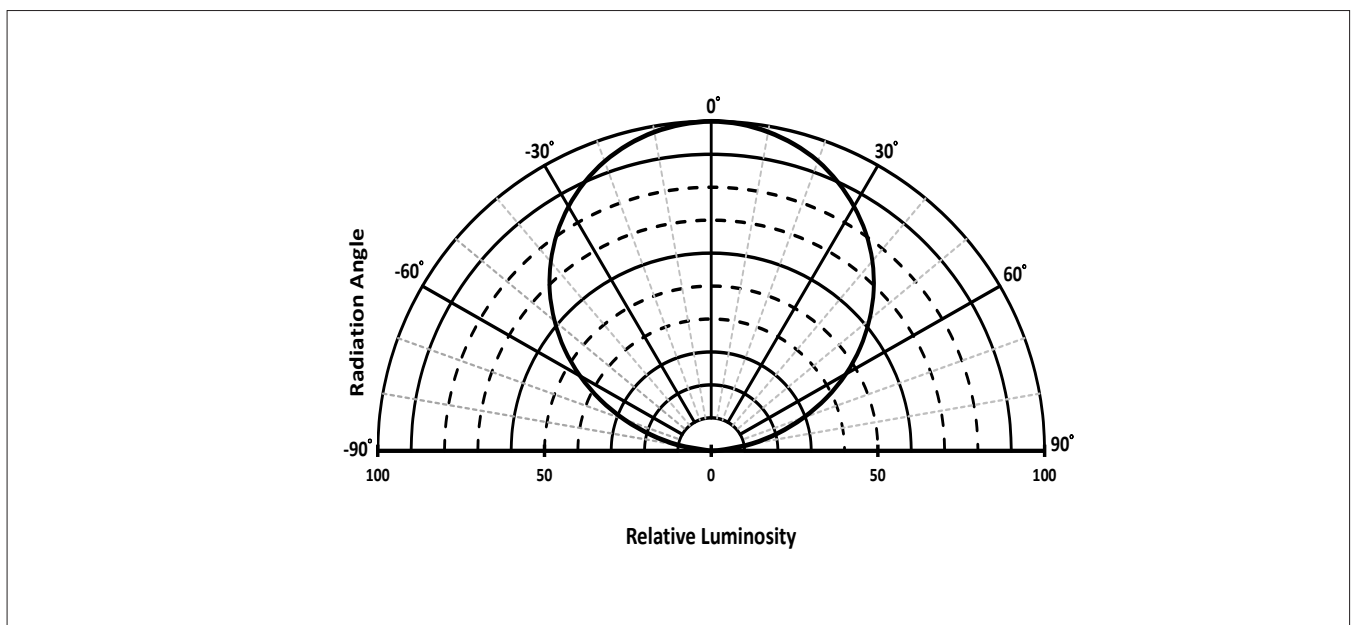

# Mechanical Dimensions

Figure 16: Drawing for SMD 2835

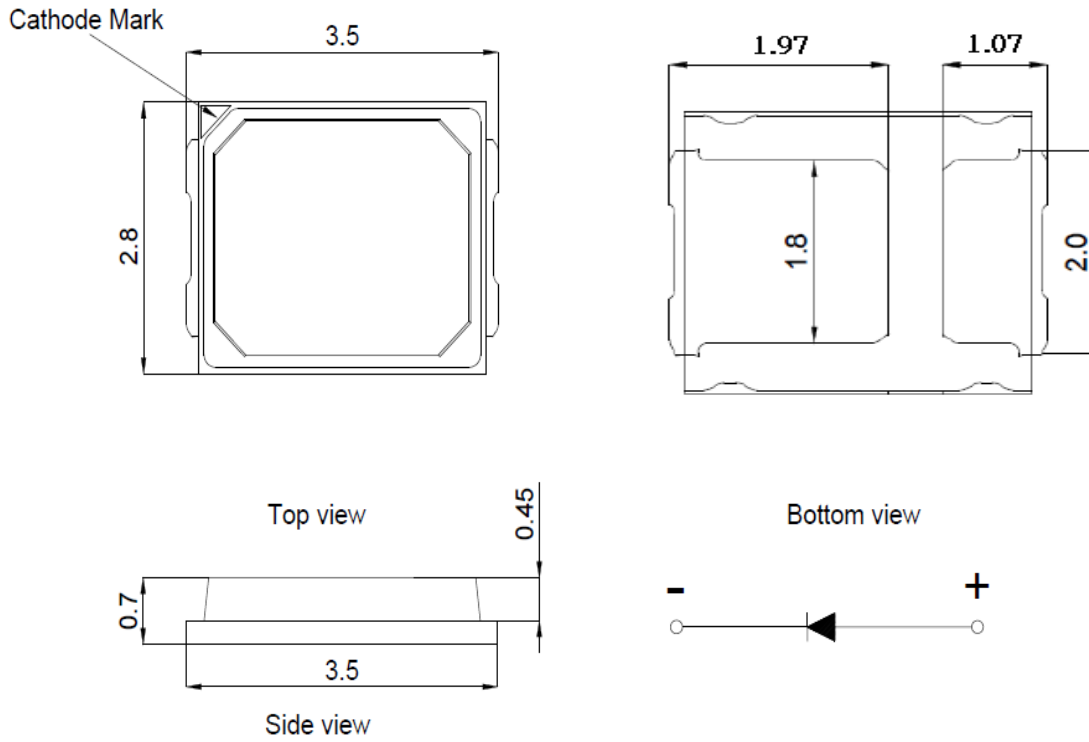

Notes for Figure 16:

1. Drawings are not to scale.
2. Drawing dimensions are in millimeters.
3. Unless otherwise specified, tolerances are  $\pm 0.10\text{mm}$ .

## Recommended PCB Soldering Pad Pattern

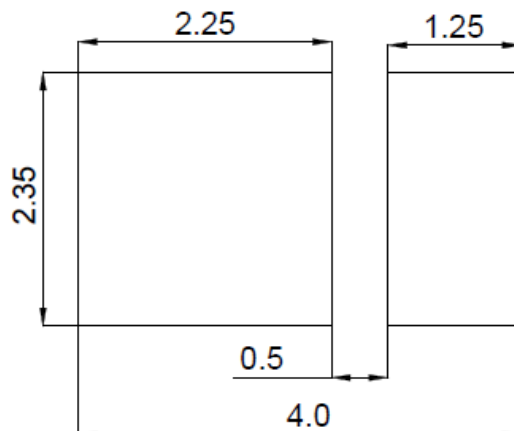



# Reliability

**Table 9:** Reliability Test Items and Conditions

No .	Items	Reference Standard	Test Conditions	Drive Current	Test Duration	Units Failed/Tested
1	Moisture/Reflow Sensitivity	J-STD-020E	$T_{\text{slid}} = 260^{\circ}\text{C}$ , 10sec. Precondition: $60^{\circ}\text{C}$ , 60%RH, 168hr	-	3 reflows	0/22
2	Low Temperature Storage	JESD22-A119	$T_{\text{a}} = -40^{\circ}\text{C}$	-	1000 hours	0/22
3	High Temperature Storage	JESD22-A103D	$T_{\text{a}} = 105^{\circ}\text{C}$	-	1000 hours	0/22
4	Low Temperature Operating Life	JESD22-A108D	$T_{\text{a}} = -40^{\circ}\text{C}$	150mA	1000 hours	0/22
5	Temperature Humidity Operating Life	JESD22-A101C	$T_{\text{sp}} = 85^{\circ}\text{C}$ , RH=85%	150mA	1000 hours	0/22
6	High Temperature Operating Life	JESD22-A108D	$T_{\text{sp}} = 105^{\circ}\text{C}$	150mA	1000 hours	0/22
7	Power switching	IEC62717:2014	$T_{\text{sp}} = 105^{\circ}\text{C}$ 30 sec on, 30 sec off	150mA	30000 cycles	0/22
8	Thermal Shock	JESD22-A106B	$T_{\text{a}} = -40^{\circ}\text{C} \sim 100^{\circ}\text{C}$ ; Dwell : 15min; Transfer: 10sec	-	200 cycles	0/22
9	Temperature Cycle	JESD22-A104E	$T_{\text{a}} = -40^{\circ}\text{C} \sim 100^{\circ}\text{C}$ ; Dwell at extreme temperature: 15min; Ramp rate $< 105^{\circ}\text{C}/\text{min}$	-	200 cycles	0/22
10	Electrostatic Discharge	JS-001-2012	HBM, 2KV, 1.5k $\Omega$ , 100pF. Alternately positive or negative	-	-	0/22

## Passing Criteria

Item	Symbol	Test Condition	Passing Criteria
Forward Voltage	Vf	150mA	Vf<10%
Luminous Flux	Fv	150mA	Fv<30%
Chromaticity Coordinates	(x, y)	150mA	u'v<0.007

Notes for Table 9:

1. Measurements are performed after allowing the LEDs to return to room temperature
2.  $T_{\text{slid}}$  : reflow soldering temperature;  $T_{\text{a}}$  : ambient temperature

# Reflow Characteristics

Figure 17 : Reflow Profile

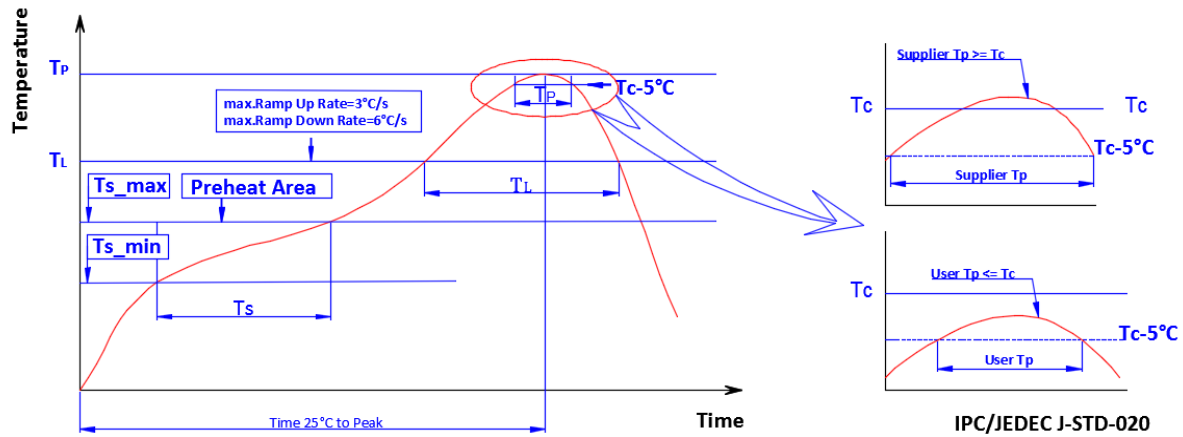

Profile Feature	Lead Free Assembly
Temperature Min. ( $T_s_{min}$ )	160°C
Temperature Max. ( $T_s_{max}$ )	205°C
Time (ts) from $T_s_{min}$ to $T_s_{max}$	60-150 seconds
Ramp-Up Rate ( $T_L$ to $T_p$ )	3 °C/second
Liquidus Temperature ( $T_L$ )	220 °C
Time ( $T_L$ ) Maintained Above $T_L$	60-150 seconds
Peak Temp( $T_p$ )	260 °C max.
Time ( $T_p$ ) Within 5 °C of the Specified Classification Temperature ( $T_c$ )	25 seconds max.
Ramp-Down Rate ( $T_p$ to $T_L$ )	5 °C/second max.
Time 25 °C to Peak Temperature	10 minutes max.

# Packaging

**Figure 18: Emitter Reel Drawings**

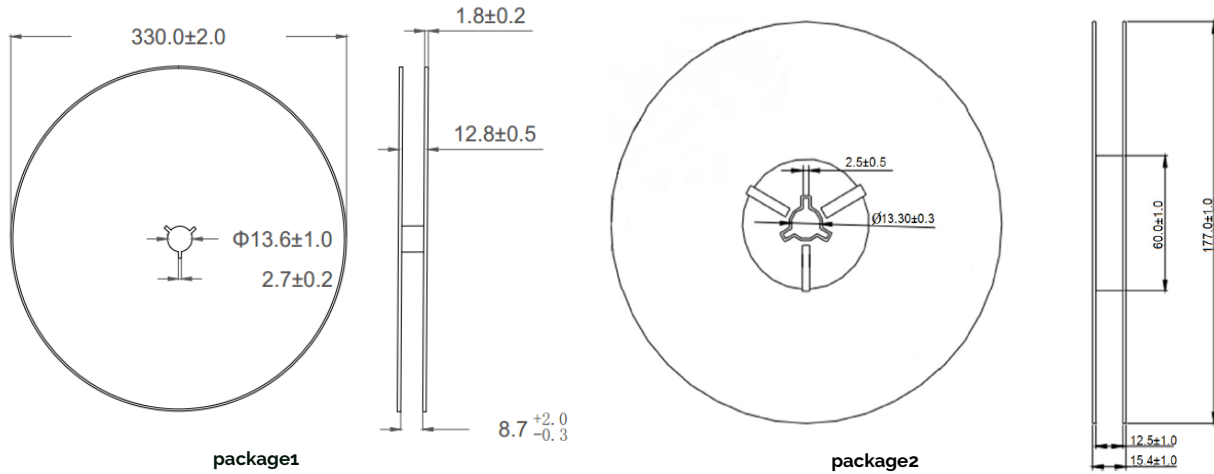

Note for Figure 18:

1. Drawings are not to scale. Drawing dimensions are in millimeters.

**Figure 19: Emitter Tape Drawings**

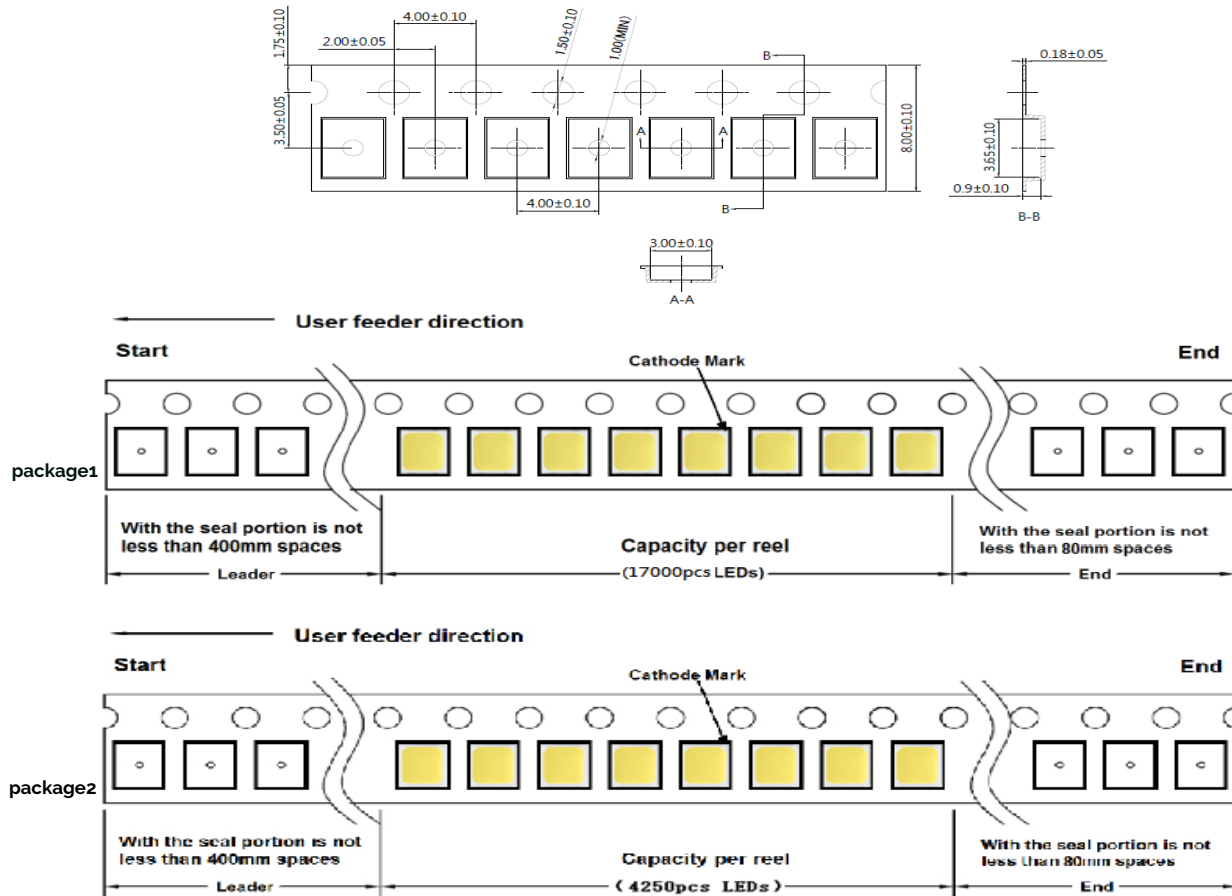

Note for Figure 19:

1. Drawings are not to scale. Drawing dimensions are in millimeters.

# Packaging

Figure 20: Emitter Reel Packaging Drawings

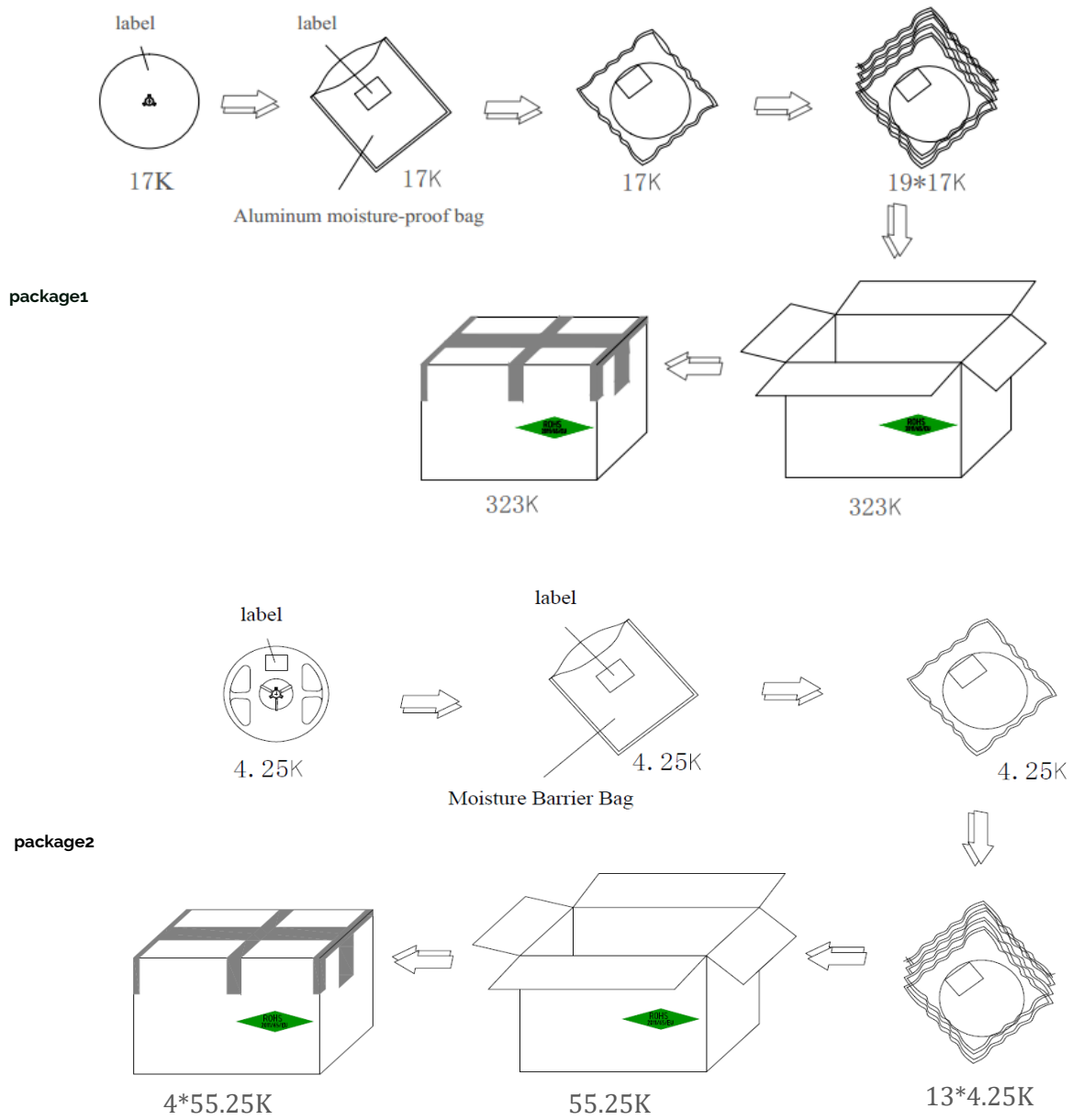

Note for Figure 20:  
1. Drawings are not to scale.

# Design Resources

Please contact your Bridgelux sales representative for assistance.

## Precautions

### **CAUTION: CHEMICAL EXPOSURE HAZARD**

Exposure to some chemicals commonly used in luminaire manufacturing and assembly can cause damage to the LED emitter. Please consult Bridgelux Application Note AN51 for additional information.

### **CAUTION: EYE SAFETY**

Eye safety classification for the use of Bridgelux SMD LED emitter is in accordance with IEC specification EN62778: Application of IEC 62471 for the assessment of blue light hazard to light sources and luminaires are classified as Risk Group 1 when operated at or below the maximum drive current. Please use appropriate precautions. It is important that employees working with LEDs are trained to use them safely.

### **CAUTION: RISK OF BURN**

Do not touch the SMD LED emitter during operation. Allow the emitter to cool for a sufficient period of time before handling. The SMD LED emitter may reach elevated temperatures such that could burn skin when touched.

## Disclaimers

### **MINOR PRODUCT CHANGE POLICY**

The rigorous qualification testing on products offered by Bridgelux provides performance assurance. Slight cosmetic changes that do not affect form, fit, or function may occur as Bridgelux continues product optimization.

## CAUTION

### **CONTACT WITH LIGHT EMITTING SURFACE (LES)**

Avoid any contact with the LES. Do not touch the LES of the emitter or apply stress to the LES (yellow phosphor resin area). Contact may cause damage to the emitter

Optics and reflectors must not be mounted in contact with the LES (yellow phosphor resin area).

### **STANDARD TEST CONDITIONS**

Unless otherwise stated, LED emitter testing is performed at the nominal drive current.

# About Bridgelux: Bridging Light and Life™

At Bridgelux, we help companies, industries and people experience the power and possibility of light. Since 2002, we've designed LED solutions that are high performing, energy efficient, cost effective and easy to integrate. Our focus is on light's impact on human behavior, delivering products that create better environments, experiences and returns—both experiential and financial. And our patented technology drives new platforms for commercial and industrial luminaires.

**For more information about the company, please visit**  
**bridgelux.com**  
**twitter.com/Bridgelux**  
**facebook.com/Bridgelux**  
**youtube.com/user/Bridgelux**  
**WeChat ID: BridgeluxInChina**  
**[https://www.linkedin.com/company/bridgelux-inc-\\_2](https://www.linkedin.com/company/bridgelux-inc-_2)**



46410 Fremont Boulevard  
Fremont, CA 94538 USA  
Tel (925) 583-8400  
Fax (925) 583-8401  
**[www.bridgelux.com](http://www.bridgelux.com)**

© 2022 Bridgelux, Inc. All rights reserved 2022. Product specifications are subject to change without notice. Bridgelux and the Bridgelux stylized logo design are registered trademarks of Bridgelux, Inc. All other trademarks are the property of their respective owners.