



Bridgelux® Gen 7 V13 Array Series

Product Data Sheet DS101



Introduction

V Series



The V Series™ LED Array products deliver high quality light in a compact and cost-effective solid-state lighting package. These chip on board (CoB) arrays can be efficiently driven at twice the nominal drive current, enabling design flexibility not previously possible. This high flux density light source is designed to support a wide range of high quality, low cost directional luminaires and replacement lamps for commercial and residential applications.

The V13 LED Array is available in a variety of electrical, CCT and CRI combinations providing substantial design flexibility and energy efficiencies.

Lighting system designs incorporating these LED arrays deliver increased system level efficacy and longer service life. Typical applications include, replacement lamps, and task, accent, spot, track, wide area, security, wall pack and down lights.

Bridgelux Décor Series is our state of the art color line designed specifically for premium applications, producing unmatched LED light quality with brilliant color-rendering options and offer pleasing and inspiring lighting palettes. Bridgelux Décor Series color points are available on Vero® SE Series, Vero® Series, V Series™ and H Series™.

Décor Series Class A is based on human response testing, providing color points with a combined GAI and CRI metric.

Décor Series™ Ultra products provide a high CRI of 97 and a minimum R9 value of 93, which emphasizes the reds and color tones to which the human eye is most receptive - perfect for the most luxurious retail shops and world renowned museums. Décor Series Ultra is designed as a replacement for halogen lamps.

Décor Series™ Street and Landmark is designed to be a direct replacement for high pressure sodium lamps.

Décor Series™ Showcase is the optimal solution for replacing ceramic metal halide lamps, incorporating the same pure white light with enhanced spectrum coverage and higher efficacy.

Features

- Efficacy of 170 lm/W typical
- Compact high flux density light source
- Uniform high quality illumination
- Minimum 65, 70, 80, 90 and 95 CRI options
- Streamlined thermal path
- ENERGY STAR® / ANSI compliant color binning structure with 2, 3 and 4 SDCM options
- More energy efficient than incandescent, halogen and fluorescent lamps
- Low voltage DC operation
- Instant light with unlimited dimming
- V_f bin code backside marking

Benefits

- Enhanced optical control
- Clean white light without pixilation
- High quality true color reproduction
- Significantly reduced thermal resistance and increased operating temperatures
- Uniform consistent white light
- Lower operating costs
- Easy to use with daylight and motion detectors to enable increased energy savings
- Reduced maintenance costs
- Environmentally friendly, no disposal issue



Contents

Product Feature Map	2
Product Nomenclature	2
Product Selection Guide	3
Performance at Commonly Used Drive Currents	8
Electrical Characteristics	14
Eye Safety	15
Absolute Maximum Ratings	16
Performance Curves	17
Typical Radiation Pattern	20
Typical Color Spectrum	21
Mechanical Dimensions	22
Color Binning Information	23
Packaging and Labeling	24
Design Resources	26
Precautions	26
Disclaimers	26
About Bridgelux	27

Product Feature Map

Bridgelux arrays are fully engineered devices that provide consistent thermal and optical performance on an engineered mechanical platform. The V Series arrays are the most compact chip-on-board devices across all of

Bridgelux's LED Array products. The arrays incorporate several features to simplify design integration and assembly. Please visit www.bridgelux.com for more information on the V Series family of products.

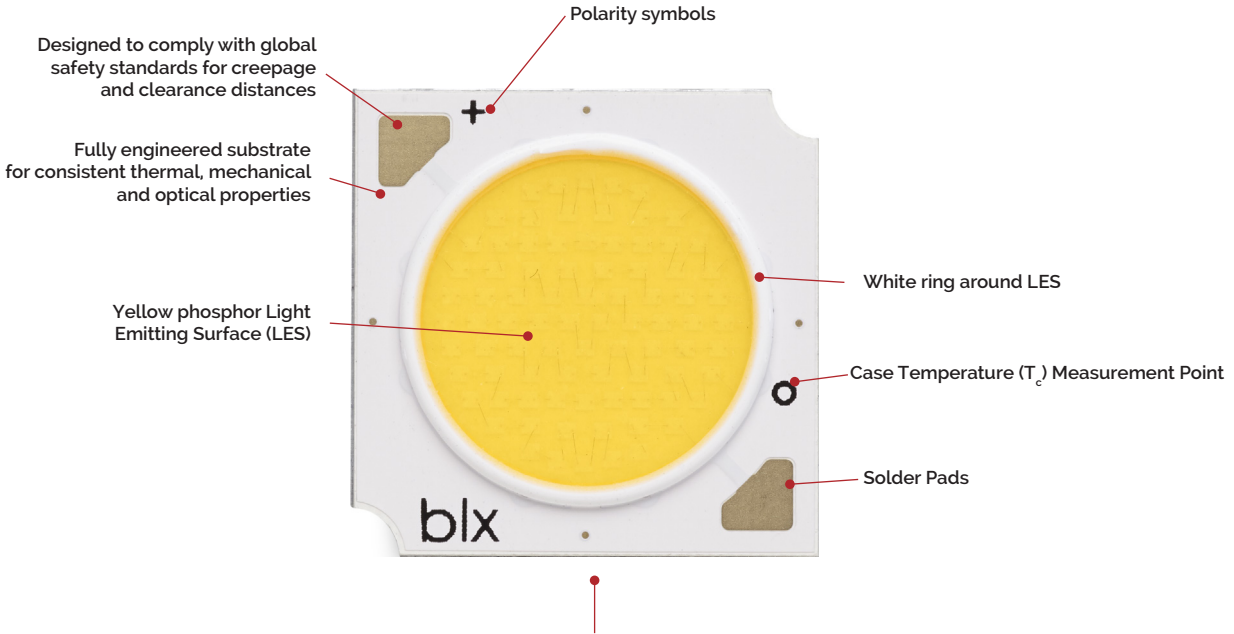

Note: Part number and lot codes are scribed on back of array

Product Nomenclature

The part number designation for Bridgelux V Series LED arrays is explained as follows:

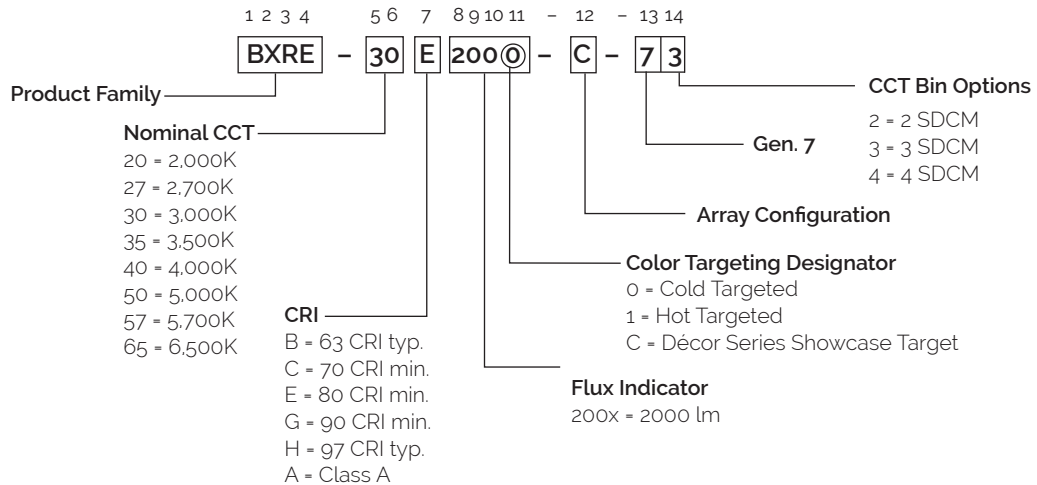

Product Selection Guide

The following product configurations are available:

Table 1: Selection Guide, Pulsed Measurement Data ($T_j = T_c = 25^\circ\text{C}$)

Part Number	Nominal CCT ¹ (K)	CRI ²	Nominal Drive Current ³ (mA)	Typical Pulsed Flux ^{4,5,6} $T_c = 25^\circ\text{C}$ (lm)	Minimum Pulsed Flux ^{6,7} $T_c = 25^\circ\text{C}$ (lm)	Typical V_f (V)	Typical Power (W)	Typical Efficacy (lm/W)
BXRE-17E2000-C-74	1750	80	630	2014	1813	34.8	21.9	92
BXRE-20B2001-B-73	2000	65	450	2455	1992	34.8	15.6	157
BXRE-20B2001-C-73	2000	65	630	3437	2853	34.8	21.9	157
BXRE-25E2000-C-74	2500	80	630	3350	3015	34.8	21.9	153
BXRE-27E2000-B-7X	2700	80	450	2502	2090	34.8	15.6	160
BXRE-27E2000-C-7X	2700	80	630	3503	2926	34.8	21.9	160
BXRE-27G20H0-B-7X	2700	90	450	2142	1928	34.8	15.6	137
BXRE-27G20H0-C-7X	2700	90	630	2999	2699	34.8	21.9	137
BXRE-27G2000-B-7X	2700	90	450	2064	1858	34.8	15.6	132
BXRE-27G2000-C-7X	2700	90	630	2890	2601	34.8	21.9	132
BXRE-27H2000-B-7X	2700	97	450	1830	1647	34.8	15.6	117
BXRE-30C2001-B-74	3000	70	450	2783	2505	34.8	15.6	178
BXRE-30C2001-C-74	3000	70	630	3897	3507	34.8	21.9	178
BXRE-30E2000-B-7X	3000	80	450	2658	2392	34.8	15.6	170
BXRE-30E2000-C-7X	3000	80	630	3722	3350	34.8	21.9	170
BXRE-30G20H0-B-7X	3000	90	450	2252	2027	34.8	15.6	144
BXRE-30G20H0-C-7X	3000	90	630	3153	2837	34.8	21.9	144
BXRE-30G2000-B-7X	3000	90	450	2158	1942	34.8	15.6	138
BXRE-30G2000-C-7X	3000	90	630	3021	2719	34.8	21.9	138
BXRE-30G200C-B-73	3000	90	450	2080	1872	34.8	15.6	133
BXRE-30G200C-C-73	3000	90	630	2912	2621	34.8	21.9	133
BXRE-30A2001-B-73 ^{8,9}	3000	93	450	1939	1745	34.8	15.6	124
BXRE-30A2001-C-73 ^{8,9}	3000	93	630	2715	2443	34.8	21.9	124
BXRE-30H2000-B-7X	3000	97	450	1955	1759	34.8	15.6	125
BXRE-35E2000-B-7X	3500	80	450	2721	2449	34.8	15.6	174
BXRE-35E2000-C-7X	3500	80	630	3809	3428	34.8	21.9	174
BXRE-35G2000-B-7X	3500	90	450	2236	2013	34.8	15.6	143
BXRE-35G2000-C-7X	3500	90	630	3131	2818	34.8	21.9	143
BXRE-35A2001-B-73 ^{8,9}	3500	93	450	2064	1858	34.8	15.6	132
BXRE-35A2001-C-73 ^{8,9}	3500	93	630	2890	2601	34.8	21.9	132
BXRE-40C2001-B-74	4000	70	450	2862	2575	34.8	15.6	183
BXRE-40C2001-C-74	4000	70	630	4006	3606	34.8	21.9	183
BXRE-40E2000-B-7X	4000	80	450	2737	2463	34.8	15.6	175
BXRE-40E2000-C-7X	4000	80	630	3831	3170	34.8	21.9	175

Notes for Table 1:

- Nominal CCT as defined by ANSI C78.377-2011. Products with a CCT of 5000K-6500K are hot targeted to $T_c = 85^\circ\text{C}$.
- CRI values are typical for Decor Series Ultra, Décor Series Street and Landmark and Decor Series Class A products. CRI values are minimums for all other products. Minimum Rg value for 80 CRI products is 0, the minimum Rg values for 90 CRI products is 50, the minimum Rg values for 97 CRI products is 93. Bridgelux maintains a ± 3 tolerance on Rg values.
- Drive current is referred to as nominal drive current.
- Products tested under pulsed condition (10ms pulse width) at nominal test current where T_j (junction temperature) - T_c (case temperature) = 25°C .
- Typical performance values are provided as a reference only and are not a guarantee of performance.
- Bridgelux maintains a $\pm 7\%$ tolerance on flux measurements.
- Minimum flux values at the nominal test current are guaranteed by 100% test.
- Nominal CCT is defined by the Lighting Research Center's Class A definition. The center of the Class A color bin is on the corresponding isothermal line.
- GAI value is 80. To help ensure optimal fixture level performance, GAI is measured at the fixture level, on axis, at a case temperature of 70°C . GAI may vary depending on fixture design and performance.

Product Selection Guide

The following product configurations are available:

Table 1: Selection Guide, Pulsed Measurement Data ($T_j = T_c = 25^\circ\text{C}$)

Part Number	Nominal CCT ¹ (K)	CRI ²	Nominal Drive Current ³ (mA)	Typical Pulsed Flux ^{4,5,6} $T_c = 25^\circ\text{C}$ (lm)	Minimum Pulsed Flux ^{6,7} $T_c = 25^\circ\text{C}$ (lm)	Typical V_f (V)	Typical Power (W)	Typical Efficacy (lm/W)
BXRE-40G2000-B-7x	4000	90	450	2283	1938	34.8	15.6	146
BXRE-40G2000-C-7x	4000	90	630	3196	2713	34.8	21.9	146
BXRE-50C2001-B-7x	5000	70	450	2877	2482	34.8	15.6	184
BXRE-50C2001-C-7x	5000	70	630	4028	3475	34.8	21.9	184
BXRE-50E2001-B-7x	5000	80	450	2768	2491	34.8	15.6	177
BXRE-50E2001-C-7x	5000	80	630	3875	3266	34.8	21.9	177
BXRE-50G2001-B-7x	5000	90	450	2393	1986	34.8	15.6	153
BXRE-50G2001-C-7x	5000	90	630	3350	2780	34.8	21.9	153
BXRE-57C2001-B-7x	5700	70	450	2799	2395	34.8	15.6	179
BXRE-57C2001-C-7x	5700	70	630	3919	3353	34.8	21.9	179
BXRE-57E2001-B-7x	5700	80	450	2658	2374	34.8	15.6	170
BXRE-57E2001-C-7x	5700	80	630	3722	3322	34.8	21.9	170
BXRE-65C2001-B-7x	6500	70	450	2799	2439	34.8	15.6	179
BXRE-65C2001-C-7x	6500	70	630	3919	3414	34.8	21.9	179
BXRE-65E2001-B-7x	6500	80	450	2690	2417	34.8	15.6	172
BXRE-65E2001-C-7x	6500	80	630	3766	3383	34.8	21.9	172

Notes for Table 1:

- Nominal CCT as defined by ANSI C78.377-2011. Products with a CCT of 5000K-6500K are hot targeted to $T_c = 85^\circ\text{C}$.
- CRI values are typical for Decor Series Ultra, Décor Series Street and Landmark and Decor Series Class A products. CRI values are minimums for all other products. Minimum Rg value for 80 CRI products is 0, the minimum Rg values for 90 CRI products is 50, the minimum Rg values for 97 CRI products is 93. Bridgelux maintains a ± 3 tolerance on Rg values.
- Drive current is referred to as nominal drive current.
- Products tested under pulsed condition (10ms pulse width) at nominal test current where T_j (junction temperature) - T_c (case temperature) = 25°C .
- Typical performance values are provided as a reference only and are not a guarantee of performance.
- Bridgelux maintains a $\pm 7\%$ tolerance on flux measurements.
- Minimum flux values at the nominal test current are guaranteed by 100% test.
- Nominal CCT is defined by the Lighting Research Center's Class A definition. The center of the Class A color bin is on the corresponding isothermal line.
- GAI value is 80. To help ensure optimal fixture level performance, GAI is measured at the fixture level, on axis, at a case temperature of 70°C . GAI may vary depending on fixture design and performance.

Product Selection Guide

Table 2: Selection Guide, Stabilized DC Performance ($T_c = 70^\circ\text{C}$) ^{7,8}

Part Number	Nominal CCT ¹ (K)	GAI ²	CRI ³	Nominal Drive Current ⁴ (mA)	Typical DC Flux ^{5,6} $T_c = 70^\circ\text{C}$ (lm)	Minimum DC Flux ^{6,9} $T_c = 70^\circ\text{C}$ (lm)	Typical V_f (V)	Typical Power (W)	Typical Efficacy (lm/W)
BXRE-30A2001-B-73	3000	80	93	450	1751	1576	34.4	15.5	113
BXRE-30A2001-C-73	3000	80	93	630	2452	2207	34.4	21.7	113
BXRE-35A2001-B-73	3500	80	93	450	1876	1688	34.4	15.5	121
BXRE-35A2001-C-73	3500	80	93	630	2622	2360	34.4	21.7	121

Notes for Table 2:

- Nominal CCT is defined by the Lighting Research Center's Class A definition. The center of the Class A color bin is on the corresponding isothermal line.
- To help ensure optimal fixture level performance, GAI is measured at the fixture level, on axis, at a case temperature of 70°C . GAI may vary depending on fixture design and performance.
- All CRI values are measured at $T_j = T_c = 25^\circ\text{C}$. CRI Values are specified as typical.
- Drive current is referred to as nominal drive current.
- Typical performance values are provided as a reference only and are not a guarantee of performance.
- Bridgelux maintains a $\pm 7\%$ tolerance on flux measurements.
- Typical stabilized DC performance values are provided as reference only and are not a guarantee of performance.
- Typical performance is estimated based on operation under DC (direct current) with LED array mounted onto a heat sink with thermal interface material and the case temperature maintained at specified temperature. Based on Bridgelux test setup, values may vary depending on the thermal design of the luminaire and/or the exposed environment to which the product is subjected.
- Minimum flux values at elevated temperatures are provided for reference only and are not guaranteed by 100% production testing. Based on Bridgelux test setup, values may vary depending on the thermal design of the luminaire and/or the exposed environment to which the product is subjected.

Product Selection Guide

Table 3: Selection Guide, Stabilized DC Performance ($T_c = 85^\circ\text{C}$)^{4,5}

Part Number	Nominal CCT ¹ (K)	CRI ²	Nominal Drive Current ³ (mA)	Typical DC Flux ^{4,5} $T_c = 85^\circ\text{C}$ (lm)	Minimum DC Flux ⁶ $T_c = 85^\circ\text{C}$ (lm)	Typical V_f (V)	Typical Power (W)	Typical Efficacy (lm/W)
BXRE-17E2000-C-74	1750	80	630	1813	1631	33.9	21.4	85
BXRE-20B2001-B-73	2000	65	450	2210	1989	33.9	15.3	145
BXRE-20B2001-C-73	2000	65	630	3093	2784	33.9	21.4	145
BXRE-25E2000-C-74	2500	80	630	3015	2713	33.9	21.4	141
BXRE-27E2000-B-7x	2700	80	450	2252	2027	33.9	15.3	148
BXRE-27E2000-C-7x	2700	80	630	3153	2837	33.9	21.4	148
BXRE-27G20H0-B-7x	2700	90	450	1928	1735	33.9	15.3	126
BXRE-27G20H0-C-7x	2700	90	630	2699	2429	33.9	21.4	126
BXRE-27G2000-B-7x	2700	90	450	1858	1672	33.9	15.3	122
BXRE-27G2000-C-7x	2700	90	630	2601	2341	33.9	21.4	122
BXRE-27H2000-B-7x	2700	97	450	1647	1482	33.9	15.3	108
BXRE-30C2001-B-74	3000	70	450	2505	2255	33.9	15.3	164
BXRE-30C2001-C-74	3000	70	630	3507	3156	33.9	21.4	164
BXRE-30E2000-B-7x	3000	80	450	2393	2153	33.9	15.3	157
BXRE-30E2000-C-7x	3000	80	630	3350	3015	33.9	21.4	157
BXRE-30G20H0-B-7x	3000	90	450	2027	1824	33.9	15.3	133
BXRE-30G20H0-C-7x	3000	90	630	2837	2554	33.9	21.4	133
BXRE-30G2000-B-7x	3000	90	450	1942	1748	33.9	15.3	127
BXRE-30G2000-C-7x	3000	90	630	2719	2447	33.9	21.4	127
BXRE-30G200C-B-73	3000	90	450	1872	1685	33.9	15.3	123
BXRE-30G200C-C-73	3000	90	630	2621	2358	33.9	21.4	123
BXRE-30A2001-B-73 ^{8,9}	3000	93	450	1745	1571	33.9	15.3	114
BXRE-30A2001-C-73 ^{8,9}	3000	93	630	2443	2199	33.9	21.4	114
BXRE-30H2000-B-7x	3000	97	450	1759	1583	33.9	15.3	115
BXRE-35E2000-B-7x	3500	80	450	2449	2204	33.9	15.3	161
BXRE-35E2000-C-7x	3500	80	630	3428	3086	33.9	21.4	161
BXRE-35G2000-B-7x	3500	90	450	2013	1811	33.9	15.3	132
BXRE-35G2000-C-7x	3500	90	630	2818	2536	33.9	21.4	132
BXRE-35A2001-B-73 ^{8,9}	3500	93	450	1858	1672	33.9	15.3	122
BXRE-35A2001-C-73 ^{8,9}	3500	93	630	2601	2341	33.9	21.4	122
BXRE-40C2001-B-74	4000	70	450	2575	2318	33.9	15.3	169
BXRE-40C2001-C-74	4000	70	630	3606	3245	33.9	21.4	169
BXRE-40E2000-B-7x	4000	80	450	2463	2217	33.9	15.3	161

Notes for Table 3:

- Nominal CCT as defined by ANSI C78.377-2011. Products with a CCT of 5000K-6500K are hot targeted to $T_c = 85^\circ\text{C}$.
- All CRI values are measured at $T_1 = T_c = 25^\circ\text{C}$. CRI values are typical for Decor Series Ultra, Décor Series Street and Landmark and Decor Series Class A products. CRI values are minimums for all other products. Minimum Rg value for 80 CRI products is 0, the minimum Rg values for 90 CRI products is 50, the minimum Rg values for 97 CRI products is 93. Bridgelux maintains a ± 3 tolerance on Rg values.
- Drive current is referred to as nominal drive current.
- Typical stabilized DC performance values are provided as reference only and are not a guarantee of performance.
- Typical performance is estimated based on operation under DC (direct current) with LED array mounted onto a heat sink with thermal interface material and the case temperature maintained at 85°C . Based on Bridgelux test setup, values may vary depending on the thermal design of the luminaire and/or the exposed environment to which the product is subjected.
- Minimum flux values at elevated temperatures are provided for reference only and are not guaranteed by 100% production testing. Based on Bridgelux test setup, values may vary depending on the thermal design of the luminaire and/or the exposed environment to which the product is subjected.
- Nominal CCT is defined by the Lighting Research Center's Class A definition. The center of the Class A color bin is on the corresponding isothermal line.
- GAI value is 80. To help ensure optimal fixture level performance, GAI is measured at the fixture level, on axis, at a case temperature of 70°C . GAI may vary depending on fixture design and performance.

Product Selection Guide

Table 3: Selection Guide, Stabilized DC Performance ($T_c = 85^\circ\text{C}$)^{4,5} (continued)

Part Number	Nominal CCT ¹ (K)	CRI ²	Nominal Drive Current ³ (mA)	Typical DC Flux ^{4,5} $T_c = 85^\circ\text{C}$ (lm)	Minimum DC Flux ⁶ $T_c = 85^\circ\text{C}$ (lm)	Typical V_f (V)	Typical Power (W)	Typical Efficacy (lm/W)
BXRE-40E2000-C-7x	4000	80	630	3448	3103	33.9	21.4	161
BXRE-40G2000-B-7x	4000	90	450	2055	1849	33.9	15.3	135
BXRE-40G2000-C-7x	4000	90	630	2877	2589	33.9	21.4	135
BXRE-50C2001-B-7x	5000	70	450	2590	2331	33.9	15.3	170
BXRE-50C2001-C-7x	5000	70	630	3625	3263	33.9	21.4	170
BXRE-50E2001-B-7x	5000	80	450	2491	2242	33.9	15.3	163
BXRE-50E2001-C-7x	5000	80	630	3487	3139	33.9	21.4	163
BXRE-50G2001-B-7x	5000	90	450	2153	1938	33.9	15.3	141
BXRE-50G2001-C-7x	5000	90	630	3015	2713	33.9	21.4	141
BXRE-57C2001-B-7x	5700	70	450	2519	2267	33.9	15.3	165
BXRE-57C2001-C-7x	5700	70	630	3527	3174	33.9	21.4	165
BXRE-57E2001-B-7x	5700	80	450	2393	2153	33.9	15.3	157
BXRE-57E2001-C-7x	5700	80	630	3350	3015	33.9	21.4	157
BXRE-65C2001-B-7x	6500	70	450	2519	2267	33.9	15.3	165
BXRE-65C2001-C-7x	6500	70	630	3527	3174	33.9	21.4	165
BXRE-65E2001-B-7x	6500	80	450	2421	2179	33.9	15.3	159
BXRE-65E2001-C-7x	6500	80	630	3389	3050	33.9	21.4	159

Notes for Table 3:

- Nominal CCT as defined by ANSI C78.377-2011. Products with a CCT of 5000K-6500K are hot targeted to $T_c = 85^\circ\text{C}$.
- All CRI values are measured at $T_c = T_a = 25^\circ\text{C}$. CRI values are typical for Decor Series Ultra, Décor Series Street and Landmark and Decor Series Class A products. CRI values are minimums for all other products. Minimum Rg value for 80 CRI products is 0, the minimum Rg values for 90 CRI products is 50, the minimum Rg values for 97 CRI products is 93. Bridgelux maintains a ± 3 tolerance on Rg values.
- Drive current is referred to as nominal drive current.
- Typical stabilized DC performance values are provided as reference only and are not a guarantee of performance.
- Typical performance is estimated based on operation under DC (direct current) with LED array mounted onto a heat sink with thermal interface material and the case temperature maintained at 85°C . Based on Bridgelux test setup, values may vary depending on the thermal design of the luminaire and/or the exposed environment to which the product is subjected.
- Minimum flux values at elevated temperatures are provided for reference only and are not guaranteed by 100% production testing. Based on Bridgelux test setup, values may vary depending on the thermal design of the luminaire and/or the exposed environment to which the product is subjected.
- Nominal CCT is defined by the Lighting Research Center's Class A definition. The center of the Class A color bin is on the corresponding isothermal line.
- GAI value is 80. To help ensure optimal fixture level performance, GAI is measured at the fixture level, on axis, at a case temperature of 70°C . GAI may vary depending on fixture design and performance.

Performance at Commonly Used Drive Currents

V Series LED arrays are tested to the specifications shown using the nominal drive currents in Table 1. V Series may also be driven at other drive currents dependent on specific application design requirements. The performance at any drive current can be derived from the current vs. voltage characteristics shown in Figures 1 & 2 and the flux vs. current characteristics shown in Figures 3 & 4. The performance at commonly used drive currents is summarized in Table 4.

Table 4: Product Performance at Commonly Used Drive Currents

Part Number	CRI	Drive Current ¹ (mA)	Typical V_f $T_c = 25^\circ\text{C}$ (V)	Typical Power $T_c = 25^\circ\text{C}$ (W)	Typical Flux ² $T_c = 25^\circ\text{C}$ (lm)	Typical DC Flux ³ $T_c = 85^\circ\text{C}$ (lm)	Typical Efficacy $T_c = 25^\circ\text{C}$ (lm/W)
BXRE-17E2000-C-74	80	158	32.3	5.1	548	519	108
		315	33.2	10.4	1057	996	101
		630	34.8	21.9	2014	1813	92
		945	36.1	34.1	2894	2707	85
		1260	37.3	47.0	3693	3442	79
BXRE-20B2001-B-7x	65	113	32.3	3.6	673	621	185
		225	33.2	7.5	1298	1191	174
		450	34.8	15.6	2455	1992	157
		675	36.0	24.3	3552	3224	146
		900	37.2	33.5	4530	4091	135
BXRE-20B2001-C-73	65	158	32.3	5.1	935	885	184
		315	33.2	10.4	1804	1700	173
		630	34.8	21.9	3437	2853	157
		945	36.1	34.1	4939	4619	145
		1260	37.3	47.0	6302	5874	134
BXRE-25E2000-C-74	80	158	32.3	5.1	911	863	179
		315	33.2	10.4	1758	1657	168
		630	34.8	21.9	3350	3015	153
		945	36.1	34.1	4813	4501	141
		1260	37.3	47.0	6142	5724	131
BXRE-27E2000-B-7x	80	113	32.3	3.6	686	633	189
		225	33.2	7.5	1323	1214	177
		450	34.8	15.6	2502	2252	160
		675	36.0	24.3	3620	3286	149
		900	37.2	33.5	4616	4170	138
BXRE-27E2000-C-7x	80	158	32.3	5.1	952	902	187
		315	33.2	10.4	1838	1733	176
		630	34.8	21.9	3503	3153	160
		945	36.1	34.1	5034	4707	148
		1260	37.3	47.0	6423	5986	137
BXRE-27G20H0-B-7x	90	113	32.3	3.6	587	542	161
		225	33.2	7.5	1133	1040	152
		450	34.8	15.6	2142	1928	137
		675	36.0	24.3	3100	2813	127
		900	37.2	33.5	3953	3570	118
BXRE-27G20H0-C-7x	90	158	32.3	5.1	815	772	160
		315	33.2	10.4	1574	1484	151
		630	34.8	21.9	2999	2699	137
		945	36.1	34.1	4310	4031	126
		1260	37.3	47.0	5499	5126	117

Notes for Table 4:

1. Alternate drive currents are provided for reference only and are not a guarantee of performance.
2. Bridgelux maintains a $\pm 7\%$ tolerance on flux measurements.
3. Typical stabilized DC performance values are provided as reference only and are not a guarantee of performance.

Performance at Commonly Used Drive Currents

Table 4: Product Performance at Commonly Used Drive Currents (Continued)

Part Number	CRI	Drive Current ¹ (mA)	Typical V _f T _c = 25°C (V)	Typical Power T _c = 25°C (W)	Typical Flux ² T _c = 25°C (lm)	Typical DC Flux ³ T _c = 85°C (lm)	Typical Efficacy T _c = 25°C (lm/W)
BXRE-27G2000-B-7x	90	113	32.3	3.6	566	522	156
		225	33.2	7.5	1092	1002	146
		450	34.8	15.6	2064	1858	132
		675	36.0	24.3	2987	2711	123
		900	37.2	33.5	3809	3440	114
BXRE-27G2000-C-7x	90	158	32.3	5.1	786	744	154
		315	33.2	10.4	1516	1429	145
		630	34.8	21.9	2890	2601	132
		945	36.1	34.1	4153	3884	122
		1260	37.3	47.0	5299	4939	113
BXRE-27H2000-B-7x	97	113	32.3	3.6	501	463	138
		225	33.2	7.5	968	888	130
		450	34.8	15.6	1830	1647	117
		675	36.0	24.3	2647	2403	109
		900	37.2	33.5	3376	3049	101
BXRE-30C2001-B-74	70	113	32.3	3.6	757	717	208
		225	33.2	7.5	1461	1377	196
		450	34.8	15.6	2783	2505	178
		675	36.0	24.3	4000	3741	164
		900	37.2	33.5	5104	4757	152
BXRE-30C2001-C-74	70	158	32.3	5.1	1068	986	210
		315	33.2	10.4	2061	1891	197
		630	34.8	21.9	3897	3507	178
		945	36.1	34.1	5638	5118	165
		1260	37.3	47.0	7190	6494	153
BXRE-30E2000-B-7x	80	113	32.3	3.6	728	672	200
		225	33.2	7.5	1406	1290	188
		450	34.8	15.6	2658	2393	170
		675	36.0	24.3	3846	3491	158
		900	37.2	33.5	4905	4430	147
BXRE-30E2000-C-7x	80	158	32.3	5.1	1012	958	199
		315	33.2	10.4	1953	1841	187
		630	34.8	21.9	3722	3350	170
		945	36.1	34.1	5348	5002	157
		1260	37.3	47.0	6824	6360	145
BXRE-30G20H0-B-7x	90	113	32.3	3.6	617	570	170
		225	33.2	7.5	1191	1093	160
		450	34.8	15.6	2252	2027	144
		675	36.0	24.3	3258	2957	134
		900	37.2	33.5	4155	3753	124
BXRE-30G20H0-C-7x	90	158	32.3	5.1	857	812	168
		315	33.2	10.4	1654	1559	158
		630	34.8	21.9	3153	2837	144
		945	36.1	34.1	4530	4237	133
		1260	37.3	47.0	5780	5388	123

Notes for Table 4:

1. Alternate drive currents are provided for reference only and are not a guarantee of performance.
2. Bridgelux maintains a ± 7% tolerance on flux measurements.
3. Typical stabilized DC performance values are provided as reference only and are not a guarantee of performance.

Performance at Commonly Used Drive Currents

Table 4: Product Performance at Commonly Used Drive Currents (Continued)

Part Number	CRI	Drive Current ¹ (mA)	Typical V _f T _c = 25°C (V)	Typical Power T _c = 25°C (W)	Typical Flux ² T _c = 25°C (lm)	Typical DC Flux ³ T _c = 85°C (lm)	Typical Efficacy T _c = 25°C (lm/W)
BXRE-30G2000-B-7x	90	113	32.3	3.6	591	546	163
		225	33.2	7.5	1141	1047	153
		450	34.8	15.6	2158	1942	138
		675	36.0	24.3	3122	2834	128
		900	37.2	33.5	3982	3596	119
BXRE-30G2000-C-7x	90	158	32.3	5.1	821	778	161
		315	33.2	10.4	1585	1494	152
		630	34.8	21.9	3021	2719	138
		945	36.1	34.1	4341	4060	127
		1260	37.3	47.0	5540	5163	118
BXRE-30G200C-B-73	90	113	32.3	3.6	570	526	157
		225	33.2	7.5	1100	1009	147
		450	34.8	15.6	2080	1872	133
		675	36.0	24.3	3009	2731	124
		900	37.2	33.5	3837	3466	115
BXRE-30G200C-C-73	90	158	32.3	5.1	798	736	157
		315	33.2	10.4	1540	1413	147
		630	34.8	21.9	2912	2621	133
		945	36.1	34.1	4213	3824	123
		1260	37.3	47.0	5372	4852	114
BXRE-30A2001-B-73	93	113	32.3	3.6	531	490	146
		225	33.2	7.5	1025	941	137
		450	34.8	15.6	1939	1745	124
		675	36.0	24.3	2806	2546	115
		900	37.2	33.5	3578	3231	107
BXRE-30A2001-C-73	93	158	32.3	5.1	744	687	146
		315	33.2	10.4	1436	1317	137
		630	34.8	21.9	2715	2443	124
		945	36.1	34.1	3928	3565	115
		1260	37.3	47.0	5009	4524	107
BXRE-30H2000-B-7x	97	113	32.3	3.6	536	494	147
		225	33.2	7.5	1034	949	139
		450	34.8	15.6	1955	1759	125
		675	36.0	24.3	2828	2567	116
		900	37.2	33.5	3607	3257	108
BXRE-35E2000-B-7x	80	113	32.3	3.6	746	688	205
		225	33.2	7.5	1439	1320	193
		450	34.8	15.6	2721	2449	174
		675	36.0	24.3	3937	3573	162
		900	37.2	33.5	5020	4534	150
BXRE-35E2000-C-7x	80	158	32.3	5.1	1036	981	203
		315	33.2	10.4	1999	1884	191
		630	34.8	21.9	3809	3428	174
		945	36.1	34.1	5474	5119	160
		1260	37.3	47.0	6985	6510	149

Notes for Table 4:

1. Alternate drive currents are provided for reference only and are not a guarantee of performance.
2. Bridgelux maintains a ± 7% tolerance on flux measurements.
3. Typical stabilized DC performance values are provided as reference only and are not a guarantee of performance.

Performance at Commonly Used Drive Currents

Table 4: Product Performance at Commonly Used Drive Currents (Continued)

Part Number	CRI	Drive Current ¹ (mA)	Typical V _f T _c = 25°C (V)	Typical Power T _c = 25°C (W)	Typical Flux ² T _c = 25°C (lm)	Typical DC Flux ³ T _c = 85°C (lm)	Typical Efficacy T _c = 25°C (lm/W)
BXRE-35G2000-B-7x	90	113	32.3	3.6	613	566	169
		225	33.2	7.5	1183	1085	158
		450	34.8	15.6	2236	2013	143
		675	36.0	24.3	3235	2937	133
		900	37.2	33.5	4126	3727	123
BXRE-35G2000-C-7x	90	158	32.3	5.1	851	806	167
		315	33.2	10.4	1643	1549	157
		630	34.8	21.9	3131	2818	143
		945	36.1	34.1	4499	4207	132
		1260	37.3	47.0	5740	5350	122
BXRE-35A2001-B-73	93	113	32.3	3.6	566	522	156
		225	33.2	7.5	1092	1002	146
		450	34.8	15.6	2064	1858	132
		675	36.0	24.3	2987	2711	123
		900	37.2	33.5	3809	3440	114
BXRE-35A2001-C-73	93	158	32.3	5.1	786	744	154
		315	33.2	10.4	1516	1429	145
		630	34.8	21.9	2890	2601	132
		945	36.1	34.1	4153	3884	122
		1260	37.3	47.0	5299	4939	113
BXRE-40C2001-B-74	70	113	32.3	3.6	784	724	216
		225	33.2	7.5	1513	1389	203
		450	34.8	15.6	2862	2575	183
		675	36.0	24.3	4140	3758	170
		900	37.2	33.5	5280	4769	158
BXRE-40C2001-C-74	70	158	32.3	5.1	1089	1032	214
		315	33.2	10.4	2102	1982	201
		630	34.8	21.9	4006	3606	183
		945	36.1	34.1	5757	5384	169
		1260	37.3	47.0	7346	6847	156
BXRE-40E2000-B-7x	80	113	32.3	3.6	750	692	206
		225	33.2	7.5	1447	1328	194
		450	34.8	15.6	2737	2463	175
		675	36.0	24.3	3959	3594	163
		900	37.2	33.5	5049	4560	151
BXRE-40E2000-C-7x	80	158	32.3	5.1	1042	987	205
		315	33.2	10.4	2010	1895	192
		630	34.8	21.9	3831	3448	175
		945	36.1	34.1	5505	5149	161
		1260	37.3	47.0	7025	6547	149
BXRE-40G2000-B-7x	90	113	32.3	3.6	626	577	172
		225	33.2	7.5	1207	1108	162
		450	34.8	15.6	2283	2055	146
		675	36.0	24.3	3303	2998	136
		900	37.2	33.5	4213	3805	126

Notes for Table 4:

1. Alternate drive currents are provided for reference only and are not a guarantee of performance.
2. Bridgelux maintains a ± 7% tolerance on flux measurements.
3. Typical stabilized DC performance values are provided as reference only and are not a guarantee of performance.

Performance at Commonly Used Drive Currents

Table 4: Product Performance at Commonly Used Drive Currents (Continued)

Part Number	CRI	Drive Current ¹ (mA)	Typical V _f T _c = 25°C (V)	Typical Power T _c = 25°C (W)	Typical Flux ² T _c = 25°C (lm)	Typical DC Flux ³ T _c = 85°C (lm)	Typical Efficacy T _c = 25°C (lm/W)
BXRE-40G2000-C-7x	90	158	32.3	5.1	869	823	171
		315	33.2	10.4	1677	1581	161
		630	34.8	21.9	3196	2877	146
		945	36.1	34.1	4593	4295	135
		1260	37.3	47.0	5861	5462	125
BXRE-50C2001-B-7x	70	113	32.3	3.6	788	728	217
		225	33.2	7.5	1522	1396	204
		450	34.8	15.6	2877	2590	184
		675	36.0	24.3	4163	3779	171
		900	37.2	33.5	5309	4795	159
BXRE-50C2001-C-7x	70	158	32.3	5.1	1095	1037	215
		315	33.2	10.4	2114	1993	202
		630	34.8	21.9	4028	3625	184
		945	36.1	34.1	5789	5414	170
		1260	37.3	47.0	7386	6884	157
BXRE-50E2001-B-7x	80	113	32.3	3.6	758	700	209
		225	33.2	7.5	1464	1343	196
		450	34.8	15.6	2768	2491	177
		675	36.0	24.3	4005	3635	165
		900	37.2	33.5	5107	4613	153
BXRE-50E2001-C-7x	80	158	32.3	5.1	1054	998	207
		315	33.2	10.4	2033	1917	195
		630	34.8	21.9	3875	3487	177
		945	36.1	34.1	5568	5208	163
		1260	37.3	47.0	7105	6622	151
BXRE-50G2001-B-7x	90	113	32.3	3.6	656	605	180
		225	33.2	7.5	1265	1161	170
		450	34.8	15.6	2393	2153	153
		675	36.0	24.3	3462	3142	142
		900	37.2	33.5	4414	3987	132
BXRE-50G2001-C-7x	90	158	32.3	5.1	911	863	179
		315	33.2	10.4	1758	1657	168
		630	34.8	21.9	3350	3015	153
		945	36.1	34.1	4813	4501	141
		1260	37.3	47.0	6142	5724	131
BXRE-57C2001-B-7x	70	113	32.3	3.6	767	708	211
		225	33.2	7.5	1480	1358	198
		450	34.8	15.6	2799	2519	179
		675	36.0	24.3	4050	3676	166
		900	37.2	33.5	5165	4665	154
BXRE-57C2001-C-7x	70	158	32.3	5.1	1065	1009	209
		315	33.2	10.4	2056	1938	197
		630	34.8	21.9	3919	3527	179
		945	36.1	34.1	5631	5266	165
		1260	37.3	47.0	7185	6697	153

Notes for Table 4:

1. Alternate drive currents are provided for reference only and are not a guarantee of performance.
2. Bridgelux maintains a ± 7% tolerance on flux measurements.
3. Typical stabilized DC performance values are provided as reference only and are not a guarantee of performance.

Performance at Commonly Used Drive Currents

Table 4: Product Performance at Commonly Used Drive Currents (Continued)

Part Number	CRI	Drive Current ¹ (mA)	Typical V_f $T_c = 25^\circ\text{C}$ (V)	Typical Power $T_c = 25^\circ\text{C}$ (W)	Typical Flux ² $T_c = 25^\circ\text{C}$ (lm)	Typical DC Flux ³ $T_c = 85^\circ\text{C}$ (lm)	Typical Efficacy $T_c = 25^\circ\text{C}$ (lm/W)
BXRE-57E2001-B-7x	80	113	32.3	3.6	728	672	200
		225	33.2	7.5	1406	1290	188
		450	34.8	15.6	2658	2393	170
		675	36.0	24.3	3846	3491	158
		900	37.2	33.5	4905	4430	147
BXRE-57E2001-C-7x	80	158	32.3	5.1	1012	958	199
		315	33.2	10.4	1953	1841	187
		630	34.8	21.9	3722	3350	170
		945	36.1	34.1	5348	5002	157
		1260	37.3	47.0	6824	6360	145
BXRE-65C2001-B-7x	70	113	32.3	3.6	767	708	211
		225	33.2	7.5	1480	1358	198
		450	34.8	15.6	2799	2519	179
		675	36.0	24.3	4050	3676	166
		900	37.2	33.5	5165	4665	154
BXRE-65C2001-C-7x	70	158	32.3	5.1	1065	1009	209
		315	33.2	10.4	2056	1938	197
		630	34.8	21.9	3919	3527	179
		945	36.1	34.1	5631	5266	165
		1260	37.3	47.0	7185	6697	153
BXRE-65E2001-B-7x	80	113	32.3	3.6	737	680	203
		225	33.2	7.5	1422	1305	191
		450	34.8	15.6	2690	2421	172
		675	36.0	24.3	3892	3532	160
		900	37.2	33.5	4963	4482	148
BXRE-65E2001-C-7x	80	158	32.3	5.1	1024	970	201
		315	33.2	10.4	1976	1863	189
		630	34.8	21.9	3766	3389	172
		945	36.1	34.1	5411	5060	159
		1260	37.3	47.0	6904	6435	147

Notes for Table 4:

1. Alternate drive currents are provided for reference only and are not a guarantee of performance.
2. Bridgelux maintains a $\pm 7\%$ tolerance on flux measurements.
3. Typical stabilized DC performance values are provided as reference only and are not a guarantee of performance.

Electrical Characteristics

Table 5: Electrical Characteristics

Part Number	Drive Current (mA)	Forward Voltage Pulsed, $T_c = 25^\circ\text{C}$ (V) ^{1, 2, 3, 8}			Typical Coefficient of Forward Voltage ⁴ $\Delta V_f / \Delta T_c$ (mV/ $^\circ\text{C}$)	Typical Thermal Resistance Junction to Case ^{5,6} R_{j-c} ($^\circ\text{C}/\text{W}$)	Driver Selection Voltages ⁷ (V)	
		Minimum	Typical	Maximum			V_f Min. Hot $T_c = 105^\circ\text{C}$ (V)	V_f Max. Cold $T_c = -40^\circ\text{C}$ (V)
BXRE-xxx200x-B-7x	450	32.1	34.8	37.4	-14.1	0.28	31.0	38.3
	900	34.4	37.2	40.0	-14.1	0.34	33.3	40.9
BXRE-xxx200x-C-7x	630	32.1	34.8	37.4	-14.1	0.20	31.0	38.3
	1260	34.5	37.3	40.1	-14.1	0.24	33.4	41.0

Notes for Table 5:

- Parts are tested in pulsed conditions, $T_c = 25^\circ\text{C}$. Pulse width is 10ms.
- Voltage minimum and maximum are provided for reference only and are not a guarantee of performance.
- Bridgelux maintains a tester tolerance of $\pm 0.10\text{V}$ on forward voltage measurements.
- Typical coefficient of forward voltage tolerance is $\pm 0.1\text{mV}$ for nominal current.
- Thermal resistance values are based from test data of a 3000K 80 CRI product.
- Thermal resistance value was calculated using total electrical input power; optical power was not subtracted from input power. The thermal interface material used during testing is not included in the thermal resistance value.
- V_f min hot and max cold values are provided as reference only and are not guaranteed by test. These values are provided to aid in driver design and selection over the operating range of the product.
- This product has been designed and manufactured per IEC 62031:2014. This product has passed dielectric withstand voltage testing at 1160 V. The working voltage designated for the insulation is 80V d.c. The maximum allowable voltage across the array must be determined in the end product application.

Eye Safety

Table 6: Eye Safety Risk Group (RG) Classifications

Part Number	Drive Current ⁵ (mA)	CCT ⁵			
		2700K/3000K	4000K ²	5000K ³	6500K ⁴
BXRE-xxx200x-B-7x	450	RG1	RG1	RG1	RG1
	675	RG1	RG1	RG1	RG2
	900	RG1	RG1	RG2	RG2
BXRE-xxx200x-C-7x	630	RG1	RG1	RG1	RG1
	945	RG1	RG1	RG2	RG2
	1260	RG1	RG2	RG2	RG2

Notes for Table 6:

1. Eye safety classification for the use of Bridgelux V Series LED arrays is in accordance with specification IEC/TR 62778: Application of IEC 62471 for the assessment of blue light hazard to light sources and luminaires.
2. For products classified as RG2 at 4000K, $E_{thr} = 1847.5$ lx.
3. For products classified as RG2 at 5000K $E_{thr} = 1315.8$ lx.
4. For products classified as RG2 at 6500K, $E_{thr} = 1124.5$ lx.
5. Please contact your Bridgelux sales representative for E_{thr} values at specific drive currents and CCTs not listed.

Absolute Maximum Ratings

Table 7: Maximum Ratings

Parameter	Maximum Rating	
LED Junction Temperature (T_j)	150°C	
Storage Temperature	-40°C to +105°C	
Operating Case Temperature ¹ (T_c)	105°C	
Soldering Temperature ²	300°C or lower for a maximum of 6 seconds	
	BXRE-xxx200x-B-7x	BXRE-xxx200x-C-7x
Maximum Drive Current ³	900mA	1260mA
Maximum Peak Pulsed Drive Current ⁴	1290mA	1800mA
Maximum Reverse Voltage ⁵	-60V	-60V

Notes for Table 7:

1. For IEC 62717 requirement, please consult your Bridgelux sales representative.
2. Refer to Bridgelux Application Note AN101: Handling and Assembly of Bridgelux V Series LED Arrays
3. Arrays may be driven at higher currents however lumen maintenance may be reduced.
4. Bridgelux recommends a maximum duty cycle of 10% and pulse width of 20 ms when operating LED Arrays at maximum peak pulsed current specified. Maximum peak pulsed currents indicate values where LED Arrays can be driven without catastrophic failures.
5. Light emitting diodes are not designed to be driven in reverse voltage and will not produce light under this condition. Maximum rating provided for reference only.

Performance Curves

Figure 1: V13B Drive Current vs. Voltage

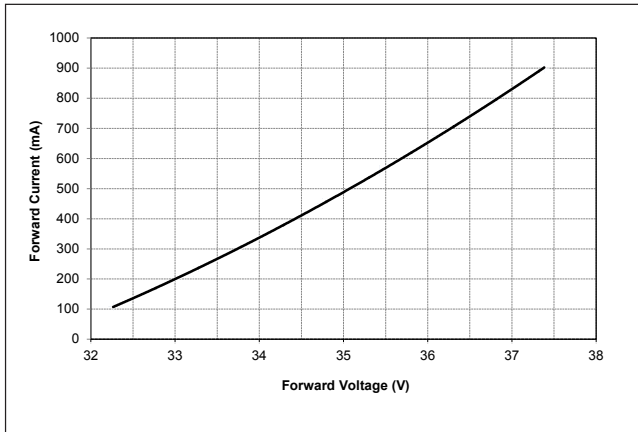

Figure 2: V13C Drive Current vs. Voltage

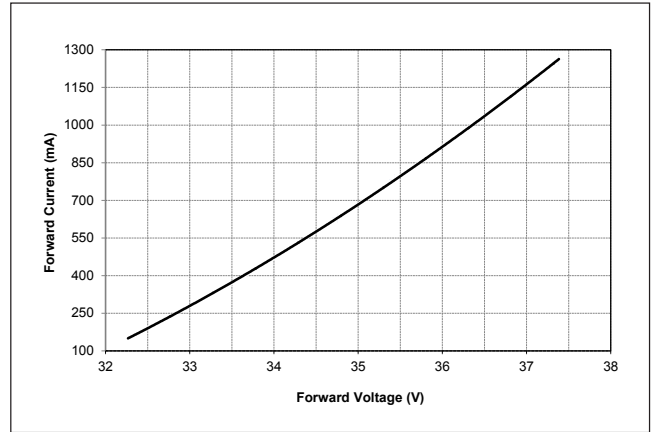

Figure 3: V13B Drive Current vs. Voltage

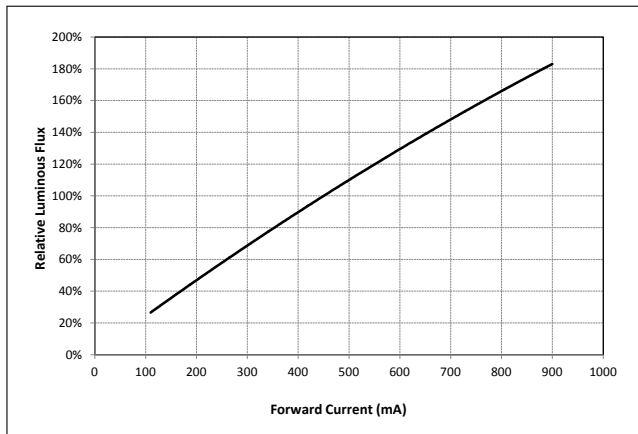
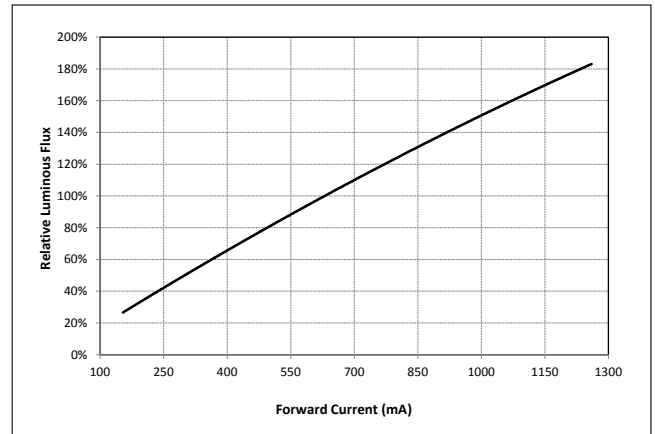

Figure 4: V13C Typical Relative Flux vs. Current



Notes for Figures 1-4:

1. Bridgelux does not recommend driving high power LEDs at low currents. Doing so may produce unpredictable results. Pulse width modulation (PWM) is recommended for dimming effects.
2. Products tested under pulsed condition (10ms pulse width) at nominal test current where T_j (junction temperature) = T_c (case temperature) = 25°C.

Performance Curves

Figure 5: Typical DC Flux vs. Case Temperature

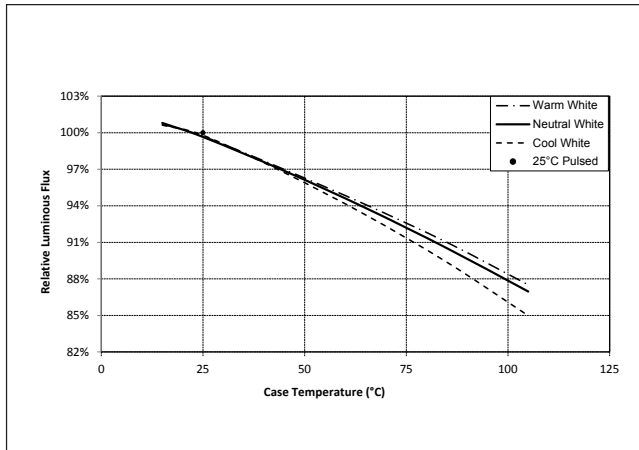

Figure 6: Typical DC ccy Shift vs. Case Temperature

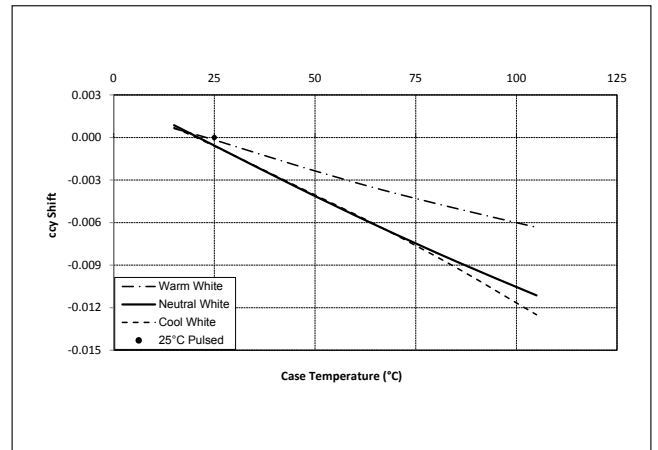
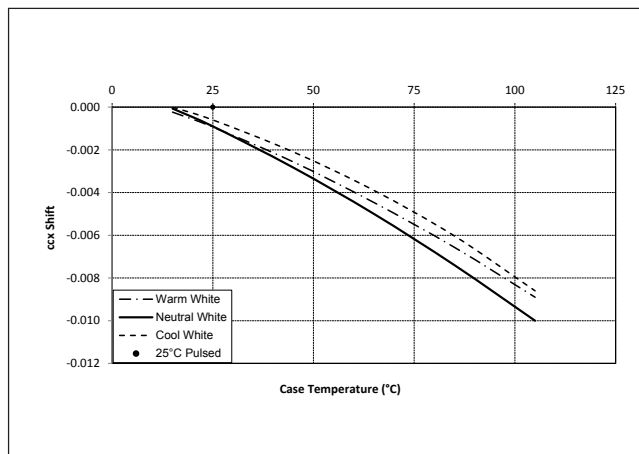

Figure 7: Typical DC ccx Shift vs. Case Temperature



Notes for Figures 5-7:

1. Characteristics shown for warm white based on 3000K and 80 CRI.
2. Characteristics shown for neutral white based on 4000K and 80 CRI.
3. Characteristics shown for cool white based on 5000K and 70 CRI.
4. Characteristics shown for warm white includes Decor Series Class A
5. For other color SKUs, the shift in color will vary. Please contact your Bridgelux Sales Representative for more information.

Performance Curves

Figure 8: 2000K, 65 CRI Color Shift vs. Case Temperature

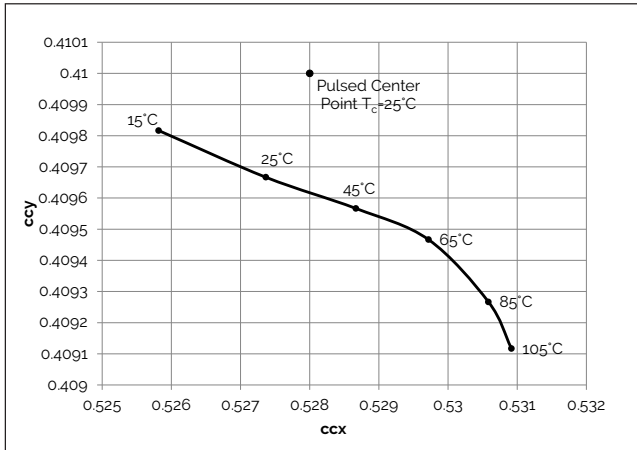

Figure 9: 3000K, 90 CRI Color Shift vs. Case Temperature^{1,3}

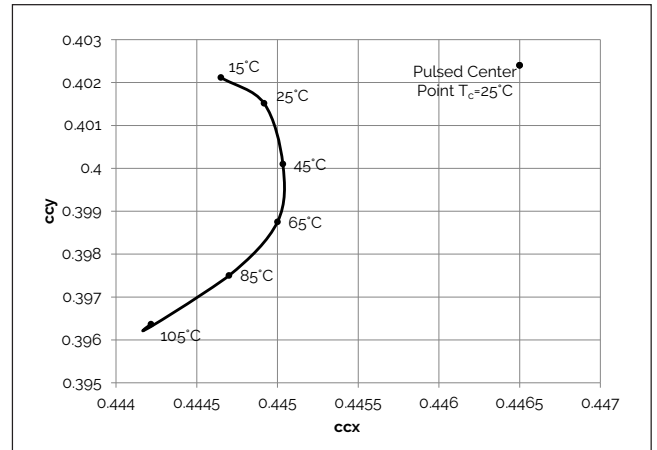

Figure 10: 2700K, 97 CRI Color Shift vs. Case Temperature¹

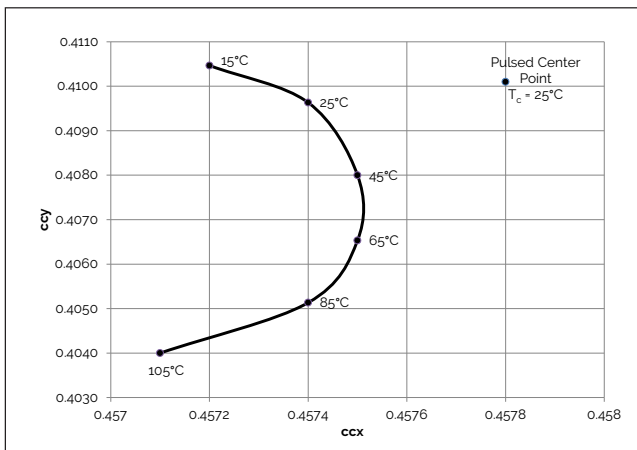

Figure 11: 3000K, 97 CRI Color Shift vs. Case Temperature¹

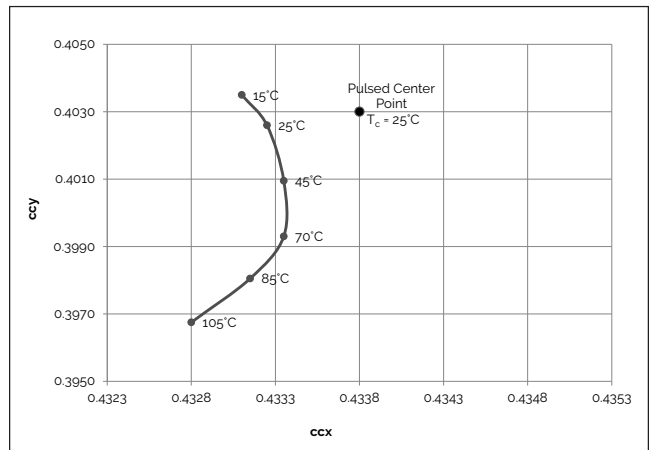

Figure 12: 3000K Class A Color Shift vs. Case Temperature¹

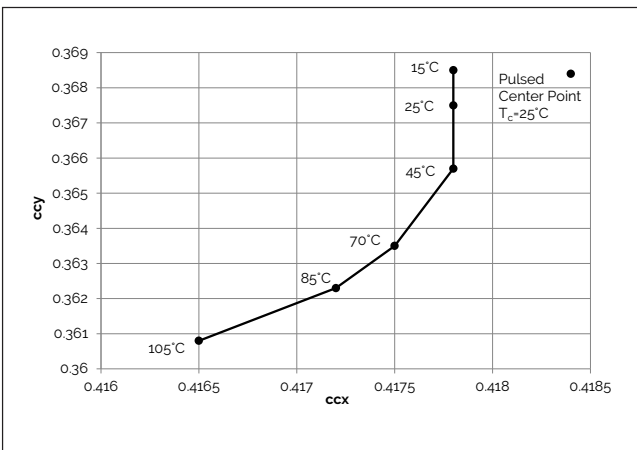
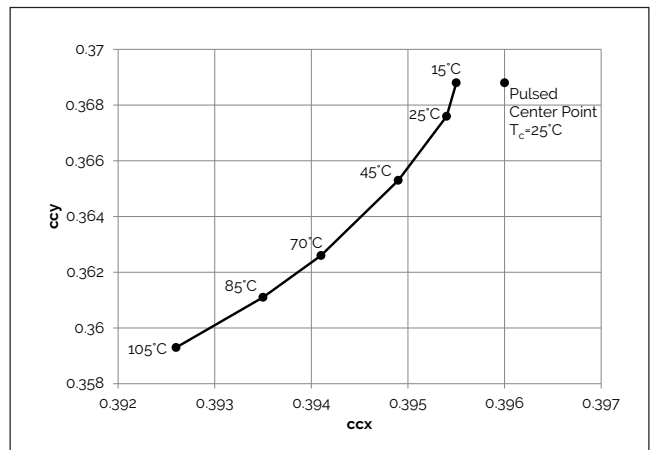

Figure 13: 3500K Class A Color Shift vs. Case Temperature¹



Note for Figures 8-12:

1. Measurements made under DC test conditions at the nominal drive current.
2. Typical color shift is shown with a tolerance of ± 0.002 .
3. Characteristics shown for Decor Series Showcase products, BXRE-30G200C-x-73

Typical Radiation Pattern

Figure 13: Typical Spatial Radiation Pattern

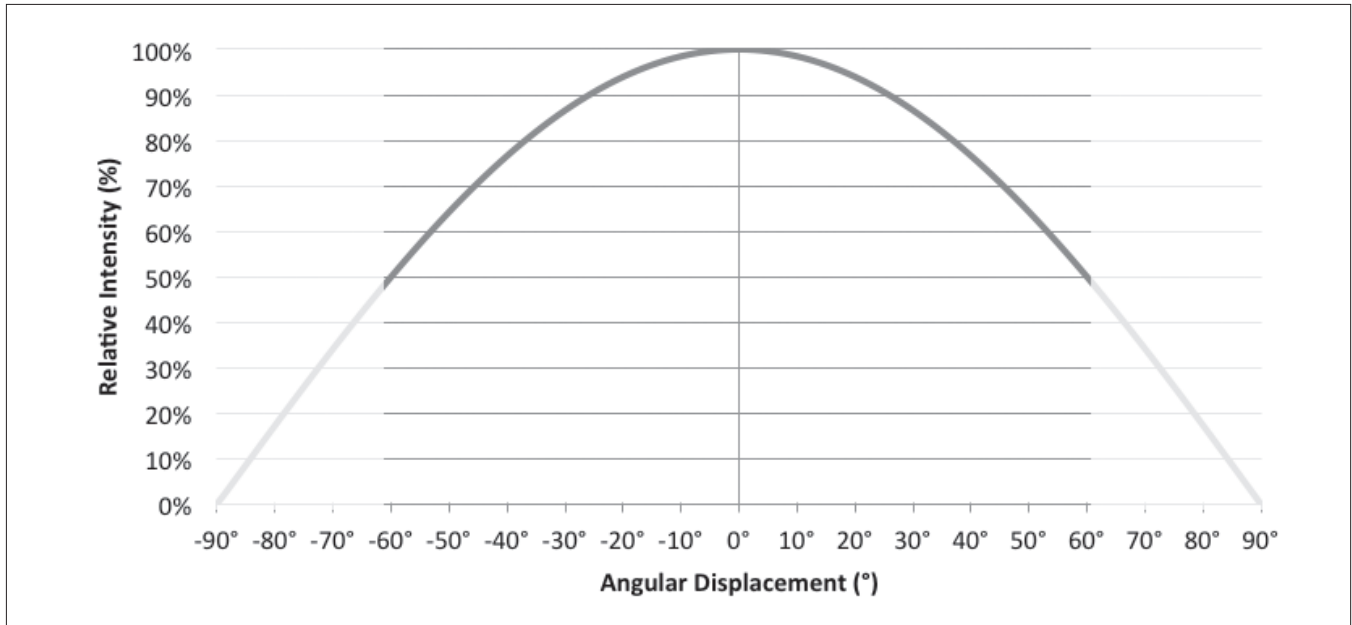

Note for Figure 13:

1. Typical viewing angle is 120°.
2. The viewing angle is defined as the off axis angle from the centerline where intensity is ½ of the peak value.

Figure 14: Typical Polar Radiation Pattern

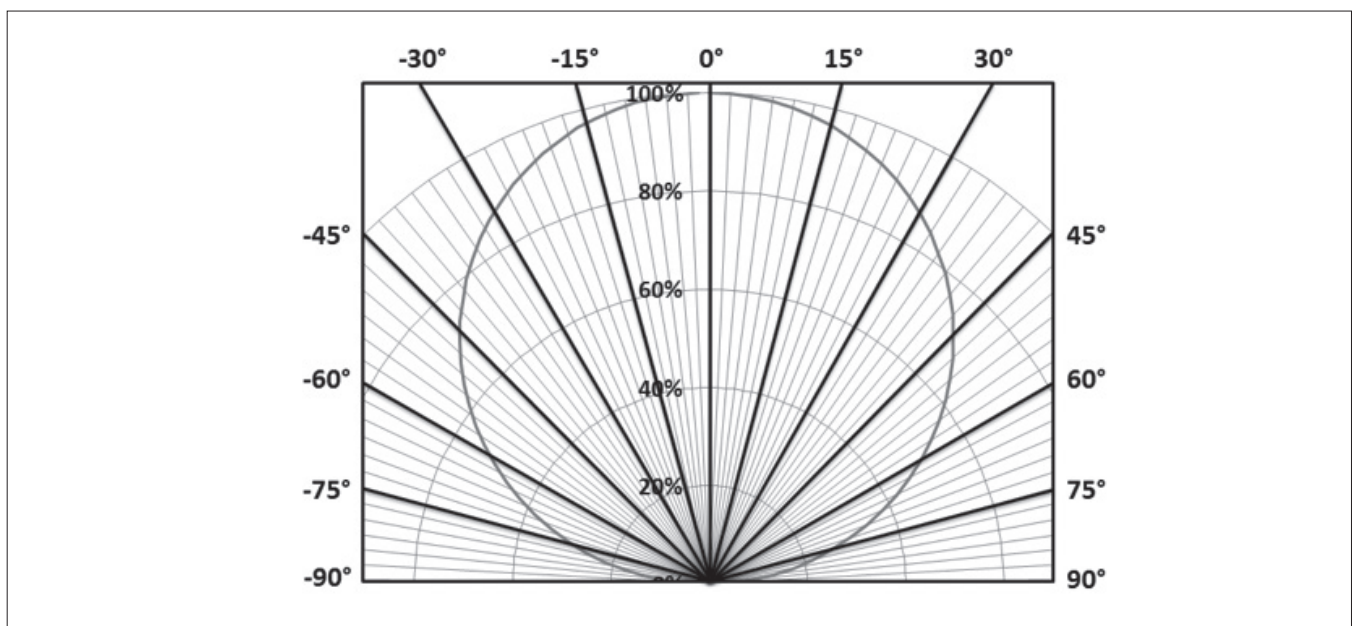

Typical Color Spectrum

Figure 15: Typical Color Spectrum

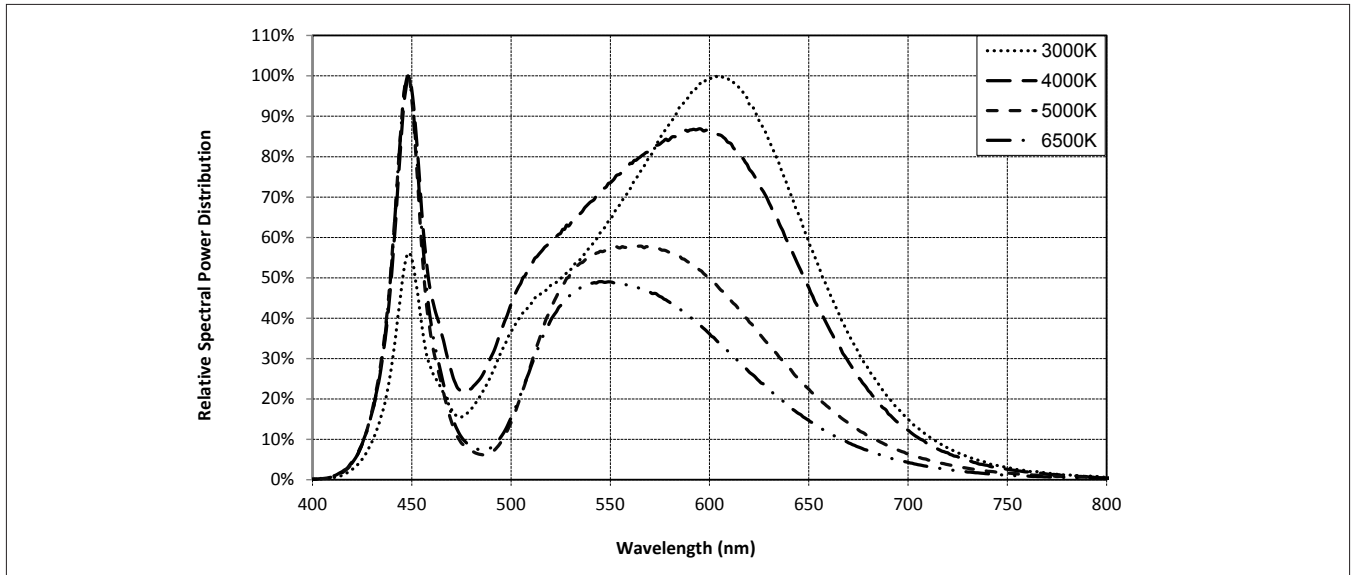

Note for Figure 15:

1. Color spectra measured at nominal current for $T_j = T_c = 25^\circ\text{C}$.
2. Color spectra shown is 3000K and 80 CRI.
3. Color spectra shown is 4000K and 80 CRI.
4. Color spectra shown is 5000K and 70 CRI.
4. Color spectra shown is 6500K and 70 CRI.

Figure 16: Typical Color Spectrum for Décor Series

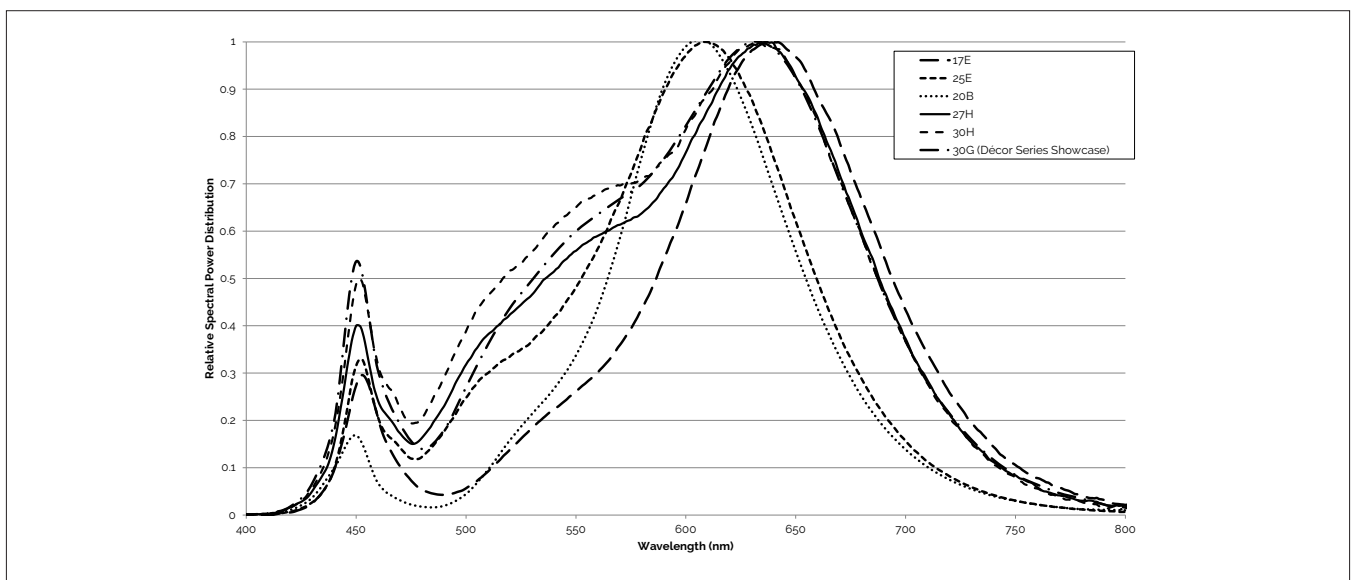

Note for Figure 16:

1. Color spectra measured at nominal current for $T_j = T_c = 25^\circ\text{C}$.

Color Binning Information

Figure 18: Warm and Neutral White Test Bins in xy Color Space

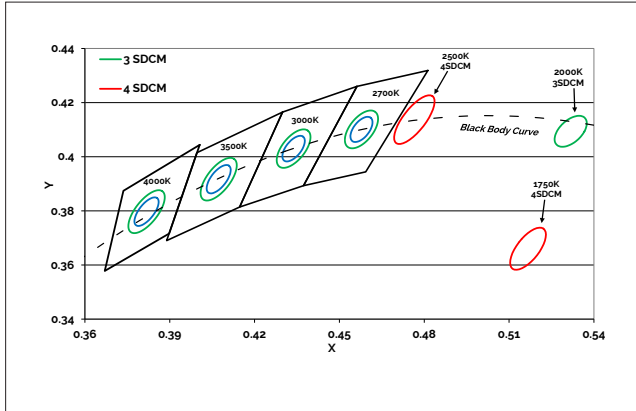

Note: Pulsed Test Conditions, $T_c = 25^\circ\text{C}$

Figure 19: Cool White Test Bins in xy Color Space

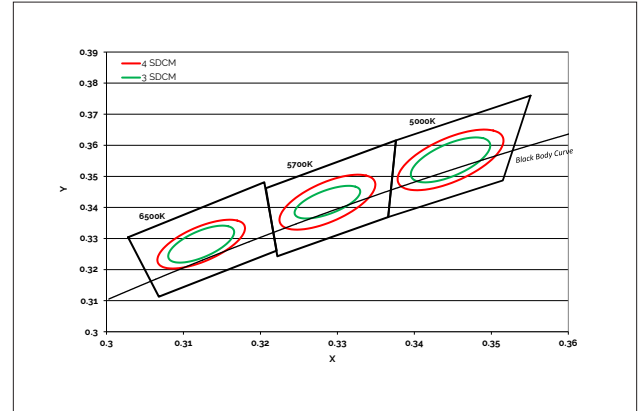

Table 8: Warm and Neutral White xy Bin Coordinates and Associated Typical CCT

Bin Code	1750K	2000K	2500K	2700K	3000K ¹	3500K ¹	4000K ¹
ANSI Bin (for reference only)	-	-	-	(2580K - 2870K)	(2870K - 3220K)	(3220K - 3710K)	(3710K - 4260K)
73 (3 SDCM)	-	-	-	(2651K - 2794K)	(2968K - 3136K)	(3369K - 3586K)	(3851K - 4130K)
72 (2 SDCM)	-	-	-	(2674K - 2769K)	(2995K - 3107K)	(3404K - 3548K)	(3895K - 4081K)
Center Point (x,y)	(0.5167, 0.336)	(0.5280, 0.4100)	(0.4765, 0.4137)	(0.4578, 0.4101)	(0.4338, 0.403) (0.4465, 0.4024) ²	(0.4073, 0.3917)	(0.3818, 0.3797)

Note for Table 8:

1. Color Binning information excludes Décor Series Class A products. Please contact your Bridgelux Sales Representative for more information.
2. Center Point for Décor Series Showcase.

Table 9: Cool White xy Bin Coordinates and Associated Typical CCT (product is hot targeted to $T_c = 85^\circ\text{C}$)

Bin Code	5000K	5700K	6500K
ANSI Bin (for reference only)	(4745K - 5311K)	(5312K - 6022K)	(6022K - 7042K)
74 (4 SDCM)	(4801K - 5282K)	(5829K - 5481K)	(6270K - 6765K)
73 (3 SDCM)	(4835K - 5215K)	(4590K - 5820K)	(6250K - 6745K)
Center Point (x,y)	(0.3447, 0.3553)	(0.3287, 0.3417)	(0.3123, 0.3282)

Packaging and Labeling

Figure 20: Drawing for V13 Packaging Tray



Notes for Figure 20:

1. Each tube holds 25 V13 COB arrays.
2. One tube is sealed in an anti-static bag. Four bags are placed in a shipping box. Depending on quantities ordered, a bigger shipping box, containing four boxes may be used to ship products.
3. Each bag and box is to be labeled as shown above.
4. Dimensions for each tube are 21.3 (W) x 9.5(H) x 505 (L). Dimensions for the anti-static bag are 75 (W) x 615 (L) x 3.1 (T) mm. Dimensions for the shipping box are 58.7 x 13.3 x 7.9 cm.

Packaging and Labeling

Figure 21: Gen. 7 Product Labeling

Bridgelux COB arrays have laser markings on the back side of the substrate to help with product identification. In addition to the product identification markings, Bridgelux COB arrays also contain markings for internal Bridgelux manufacturing use only. The image below shows which markings are for customer use and which ones are for Bridgelux internal use only. The Bridgelux internal manufacturing markings are subject to change without notice, however these will not impact the form, function or performance of the COB array.



Design Resources

Application Notes

Bridgelux has developed a comprehensive set of application notes and design resources to assist customers in successfully designing with the V Series product family of LED array products. For all available application notes visit www.bridgelux.com.

Optical Source Models

Optical source models and ray set files are available for all Bridgelux products. For a list of available formats, visit www.bridgelux.com.

3D CAD Models

Three dimensional CAD models depicting the product outline of all Bridgelux V Series LED arrays are available in both IGS and STEP formats. Please contact your Bridgelux sales representative for assistance.

LM80

LM80 testing has been completed and the LM80 report is now available. Please contact your Bridgelux sales representative for LM-80 report.

Precautions

CAUTION: CHEMICAL EXPOSURE HAZARD

Exposure to some chemicals commonly used in luminaire manufacturing and assembly can cause damage to the LED array. Please consult Bridgelux Application Note AN101 for additional information.

CAUTION: RISK OF BURN

Do not touch the V Series LED array during operation. Allow the array to cool for a sufficient period of time before handling. The V Series LED array may reach elevated temperatures such that could burn skin when touched.

CAUTION

CONTACT WITH LIGHT EMITTING SURFACE (LES)

Avoid any contact with the LES. Do not touch the LES of the LED array or apply stress to the LES (yellow phosphor resin area). Contact may cause damage to the LED array.

Optics and reflectors must not be mounted in contact with the LES (yellow phosphor resin area).

Disclaimers

MINOR PRODUCT CHANGE POLICY

The rigorous qualification testing on products offered by Bridgelux provides performance assurance. Slight cosmetic changes that do not affect form, fit, or function may occur as Bridgelux continues product optimization.

STANDARD TEST CONDITIONS

Unless otherwise stated, array testing is performed at the nominal drive current.

About Bridgelux: Bridging Light and Life™

At Bridgelux, we help companies, industries and people experience the power and possibility of light. Since 2002, we've designed LED solutions that are high performing, energy efficient, cost effective and easy to integrate. Our focus is on light's impact on human behavior, delivering products that create better environments, experiences and returns—both experiential and financial. And our patented technology drives new platforms for commercial and industrial luminaires.

For more information about the company, please visit
bridgelux.com
twitter.com/Bridgelux
facebook.com/Bridgelux
youtube.com/user/Bridgelux
linkedin.com/company/bridgelux-inc-_2
WeChat ID: BridgeluxInChina



46430 Fremont Boulevard
Fremont, CA 94538 U.S.A.
Tel (925) 583-8400
www.bridgelux.com

© 2016-2019 Bridgelux, Inc. All rights reserved. Product specifications are subject to change without notice. Bridgelux, the Bridgelux stylized logo design, Vero, V Series and V Series HD are registered trademarks, and Decor Series is a trademark of Bridgelux, Inc. All other trademarks are the property of their respective owners.

Bridgelux Gen 7 V13 Array Series Product Data Sheet DS101 Rev. N (07/2019)