

Bridgelux® SMD 2835 1W 6V

Product Data Sheet DS554

Introduction

SMD 2835



Features

- Industry-standard 2835 footprint
- Enables 3- and 6-step MacAdam ellipse custom binning kits
- RoHS compliant and lead free
- Multiple CCT configurations for a wide range of lighting applications

Benefits

- Lower operating and manufacturing cost
- Ease of design and rapid go-to-market
- Uniform, consistent white light
- Reliable and constant white point
- Compliant with environmental standards
- Design flexibility

Contents

| | |
|----------------------------|----|
| Product Feature Map | 2 |
| Product Nomenclature | 2 |
| Product Selection Guide | 3 |
| Electrical Characteristics | 4 |
| Absolute Maximum Ratings | 5 |
| Product Bin Definitions | 6 |
| Performance Curves | 9 |
| Typical Radiation Pattern | 12 |
| Typical Color Spectrum | 13 |
| Mechanical Dimensions | 14 |
| Reliability | 15 |
| Reflow Characteristics | 16 |
| Packaging | 17 |
| Design Resources | 19 |
| Precautions | 19 |
| Disclaimers | 19 |
| About Bridgelux | 20 |

Product Feature Map

Bridgelux SMD LED products come in industry standard package sizes and follow ANSI binning standards. These LEDs are optimized for cost and performance, helping to ensure highly competitive system lumen per dollar performance while addressing the stringent efficacy and reliability standards required for modern lighting applications.

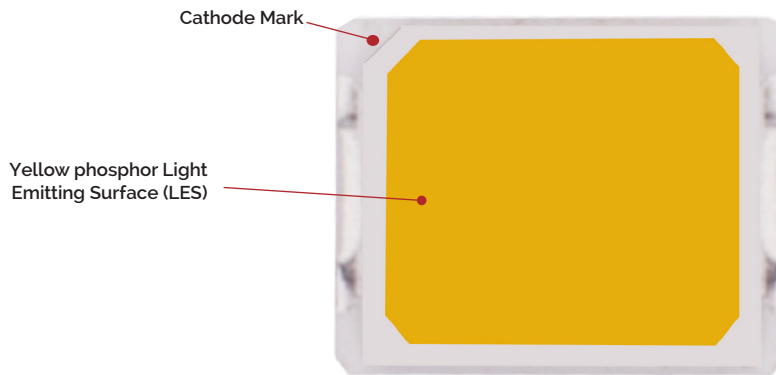

Product Nomenclature

The part number designation for Bridgelux SMD 2835 is explained as follows:

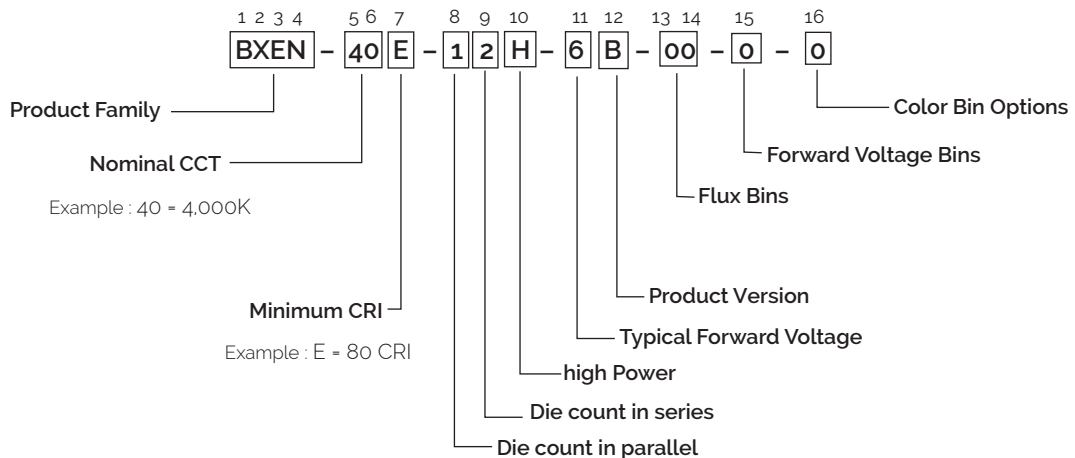

Product Selection Guide

The following product configurations are available:

Table 1: Selection Guide, Pulsed Measurement Data at 150mA ($T_j = T_{sp} = 25^\circ\text{C}$)

| Part Number ^{1,6} | Nominal CCT ² (K) | CRI ^{3,5} | Nominal Drive Current (mA) | Forward Voltage ^{4,5} (V) | | | Typical Pulsed Flux (lm) ^{4,5} | Typical Power (W) | Typical Efficacy (lm/W) |
|----------------------------|------------------------------|--------------------|----------------------------|------------------------------------|---------|------|---|-------------------|-------------------------|
| | | | | Min | Typical | Max | | | |
| BXEN-27E-12H-6B-00-0-0 | 2700 | 80 | 150 | 5.80 | 6.20 | 6.40 | 132.0 | 0.9 | 142 |
| BXEN-30E-12H-6B-00-0-0 | 3000 | 80 | 150 | 5.80 | 6.20 | 6.40 | 135.0 | 0.9 | 145 |
| BXEN-40E-12H-6B-00-0-0 | 4000 | 80 | 150 | 5.80 | 6.20 | 6.40 | 143.5 | 0.9 | 154 |
| BXEN-50E-12H-6B-00-0-0 | 5000 | 80 | 150 | 5.80 | 6.20 | 6.40 | 143.5 | 0.9 | 154 |
| BXEN-65E-12H-6B-00-0-0 | 6500 | 80 | 150 | 5.80 | 6.20 | 6.40 | 143.5 | 0.9 | 154 |

Table 2: Selection Guide, Pulsed Test Performance ($T_{sp} = 85^\circ\text{C}$)^{7,8}

| Part Number ^{1,6} | Nominal CCT ² (K) | CRI ^{3,5} | Nominal Drive Current (mA) | Forward Voltage ^{4,5} (V) | | | Typical Pulsed Flux (lm) ^{4,5} | Typical Power (W) | Typical Efficacy (lm/W) |
|----------------------------|------------------------------|--------------------|----------------------------|------------------------------------|---------|------|---|-------------------|-------------------------|
| | | | | Min | Typical | Max | | | |
| BXEN-27E-12H-6B-00-0-0 | 2700 | 80 | 150 | 5.65 | 6.05 | 6.25 | 117.3 | 0.9 | 129 |
| BXEN-30E-12H-6B-00-0-0 | 3000 | 80 | 150 | 5.65 | 6.05 | 6.25 | 120.0 | 0.9 | 132 |
| BXEN-40E-12H-6B-00-0-0 | 4000 | 80 | 150 | 5.65 | 6.05 | 6.25 | 127.5 | 0.9 | 140 |
| BXEN-50E-12H-6B-00-0-0 | 5000 | 80 | 150 | 5.65 | 6.05 | 6.25 | 127.5 | 0.9 | 140 |
| BXEN-65E-12H-6B-00-0-0 | 6500 | 80 | 150 | 5.65 | 6.05 | 6.25 | 127.5 | 0.9 | 140 |

Notes for Tables 1 & 2:

- The last 6 characters (including hyphens '-') refer to flux bins, forward voltage bins, and color bin options, respectively. "00-0-0" denotes the full distribution of flux, forward voltage, and color bin.
- Product CCT is cold targeted at $T_{sp} = 25^\circ\text{C}$. Nominal CCT as defined by ANSI C78.377-2011.
- Listed CRIs are minimum values.
- Products tested under pulsed condition (10ms pulse width) at nominal drive current.
- Bridgelux maintains a $\pm 7.5\%$ tolerance on luminous flux measurements, $\pm 0.15\text{V}$ tolerance on forward voltage measurements, and ± 2 tolerance on CRI measurements for the SMD 2835.
- Refer to Table 5 and Table 6 for Bridgelux SMD 2835 Luminous Flux Binning and Forward Voltage Binning information.
- Typical pulsed test performance values are provided as reference only and are not a guarantee of performance.
- Typical performance is estimated based on operation under pulsed current with LED emitter mounted onto a heat sink with thermal interface material and the solder point temperature maintained at 25°C . Based on Bridgelux test setup, values may vary depending on the thermal design of the luminaire and the exposed environment to which the product is subjected.

Electrical Characteristics

Table 3: Electrical Characteristics

| Part Number ¹ | Drive Current (mA) | Forward Voltage (V) ^{2,3} | | | Typical Temperature Coefficient of Forward Voltage $\Delta V_f / \Delta T$ (mV/°C) | Typical Thermal Resistance Junction to Solder Point ⁴ R_{j-sp} (°C/W) |
|--------------------------|--------------------|------------------------------------|---------|---------|--|--|
| | | Minimum | Typical | Maximum | | |
| BXEN-XXE-12H-6B-00-0-0 | 150 | 5.80 | 6.20 | 6.40 | -0.82 | 17 |

Notes for Table 3:

1. Bridgelux maintains a tolerance of $\pm 0.15V$ on forward voltage measurements. Voltage minimum and maximum values at the nominal drive current are guaranteed by 100% test.
2. Products tested under pulsed condition (10ms pulse width) at nominal drive current where $T_{sp} = 25^{\circ}C$.
3. Thermal resistance value was calculated using total electrical input power; optical power was not subtracted from input power.

Absolute Maximum Ratings

Table 4: Maximum Ratings

| Parameter | Maximum Rating |
|--|---|
| LED Junction Temperature (T_j) | 125°C |
| Storage Temperature | -40°C to +105°C |
| Operating Solder Point Temperature (T_{sp}) | -40°C to +105°C |
| Soldering Temperature | 260°C or lower for a maximum of 10 seconds |
| Maximum Drive Current | 150mA |
| Maximum Peak Pulsed Forward Current ¹ | 300mA |
| Maximum Reverse Voltage ² | - |
| Moisture Sensitivity Rating | MSL 3 |
| Electrostatic Discharge | 2kV HBM. JEDEC-JS-001-HBM and JEDEC-JS-001-2012 |

Notes for Table 4:

1. Bridgelux recommends a maximum duty cycle of 10% and pulse width of 10 ms when operating LED SMD at maximum peak pulsed current specified. Maximum peak pulsed current indicate values where LED SMD can be driven without catastrophic failures.
2. Light emitting diodes are not designed to be driven in reverse voltage and will not produce light under this condition. no rating is provided.

Product Bin Definitions

Table 5 lists the standard photometric luminous flux bins for Bridgelux SMD 2835 LEDs. Although several bins are listed, product availability in a particular bin varies by production run and by product performance. Not all bins are available in all CCTs.

Table 5: Luminous Flux Bin Definitions at 150mA, $T_{sp}=25^{\circ}\text{C}$

| Bin Code | Minimum | Maximum | Unit | Condition |
|----------|---------|---------|------|--------------------|
| 5H | 125 | 130 | lm | $I_F=150\text{mA}$ |
| 5J | 130 | 135 | | |
| 5K | 135 | 140 | | |
| 5L | 140 | 145 | | |
| 5M | 145 | 150 | | |

Note for Table 5:

1. Bridgelux maintains a tolerance of $\pm 7.5\%$ on luminous flux measurements.

Table 6: Forward Voltage Bin Definition at 150mA, $T_{sp}=25^{\circ}\text{C}$

| Bin Code | Minimum | Maximum | Unit | Condition |
|----------|---------|---------|------|--------------------|
| H | 5.8 | 6.0 | V | $I_F=150\text{mA}$ |
| J | 6.0 | 6.2 | | |
| K | 6.2 | 6.4 | | |

Note for Table 6:

1. Bridgelux maintains a tolerance of $\pm 0.1\text{V}$ on forward voltage measurements.

Product Bin Definitions

Table 7: MacAdam Ellipse Color Bin Definitions

| CCT | Color Space | Center Point | | Major Axis | Minor Axis | Ellipse Rotation Angle | Color Bin |
|-------|-------------|--------------|--------|------------|------------|------------------------|-----------|
| | | X | Y | | | | |
| 2700K | 3 SDCM | 0.4578 | 0.4101 | 0.0081 | 0.0042 | 53.70 | 1 |
| | 6 SDCM | 0.4578 | 0.4101 | 0.0162 | 0.0084 | 53.70 | 1/A/B/C/D |
| 3000K | 3 SDCM | 0.4338 | 0.4030 | 0.00834 | 0.00408 | 53.22 | 1 |
| | 6 SDCM | 0.4338 | 0.4030 | 0.01668 | 0.00816 | 53.22 | 1/A/B/C/D |
| 4000K | 3 SDCM | 0.3818 | 0.3797 | 0.00939 | 0.00402 | 53.72 | 1 |
| | 6 SDCM | 0.3818 | 0.3797 | 0.01878 | 0.00804 | 53.72 | 1/A/B/C/D |
| 5000K | 3 SDCM | 0.3447 | 0.3553 | 0.00822 | 0.00354 | 59.62 | 1 |
| | 6 SDCM | 0.3447 | 0.3553 | 0.01644 | 0.00708 | 59.62 | 1/A/B/C/D |
| 6500K | 3 SDCM | 0.3123 | 0.3282 | 0.00669 | 0.00285 | 58.57 | 1 |
| | 6 SDCM | 0.3123 | 0.3282 | 0.01338 | 0.0057 | 58.57 | 1/A/B/C/D |

Notes for Table 7:

1. Color binning at $T_{sp} = 25^{\circ}\text{C}$ unless otherwise specified
2. Bridgelux maintains a tolerance of ± 0.007 on x and y color coordinates in the CIE 1931 color space.

Product Bin Definitions

Figure 1: C.I.E. 1931 Chromaticity Diagram (5 Color Bin Structure, Cold-color Targeted at $T_{sp} = 25^{\circ}\text{C}$)

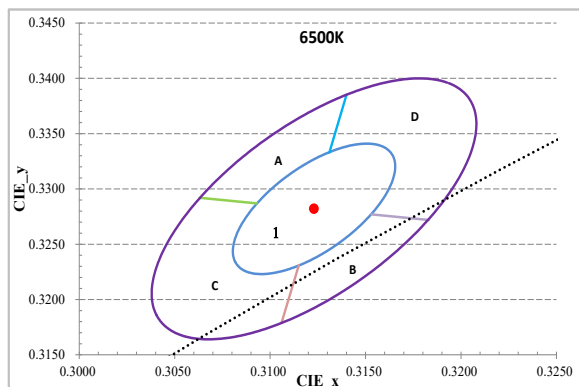
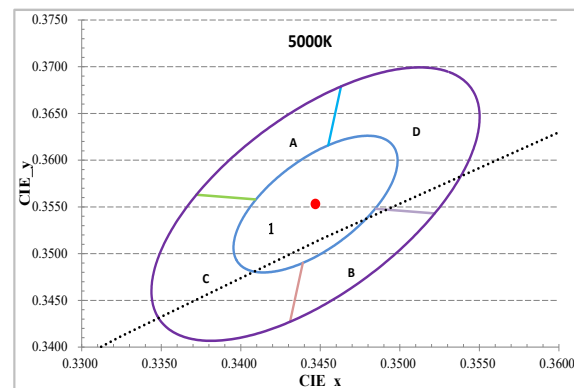
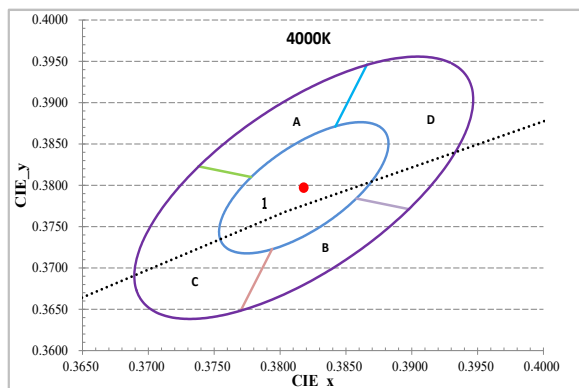
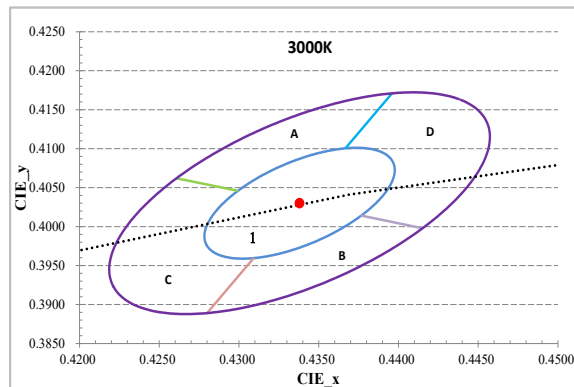
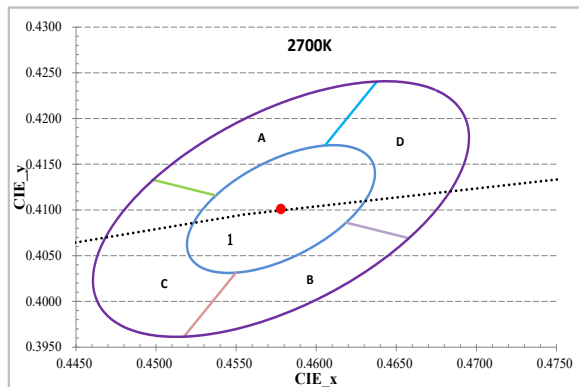

Performance Curves

Figure 2: Drive Current vs. Forward Voltage ($T_{sp}=25^{\circ}\text{C}$)

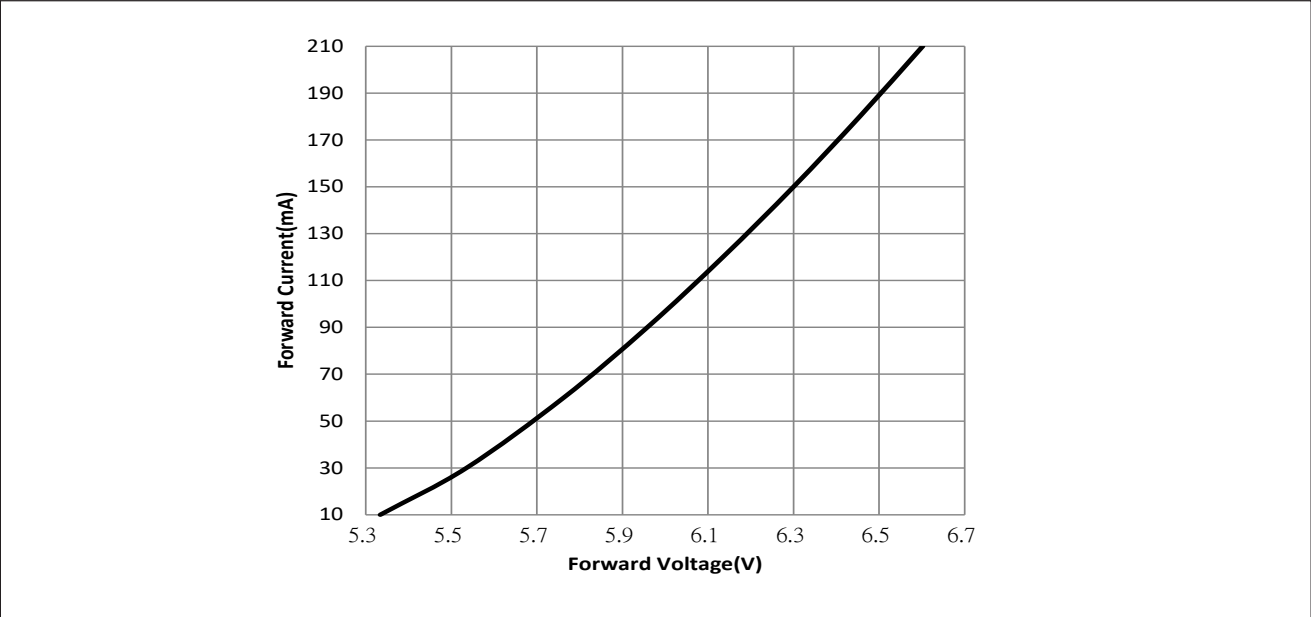
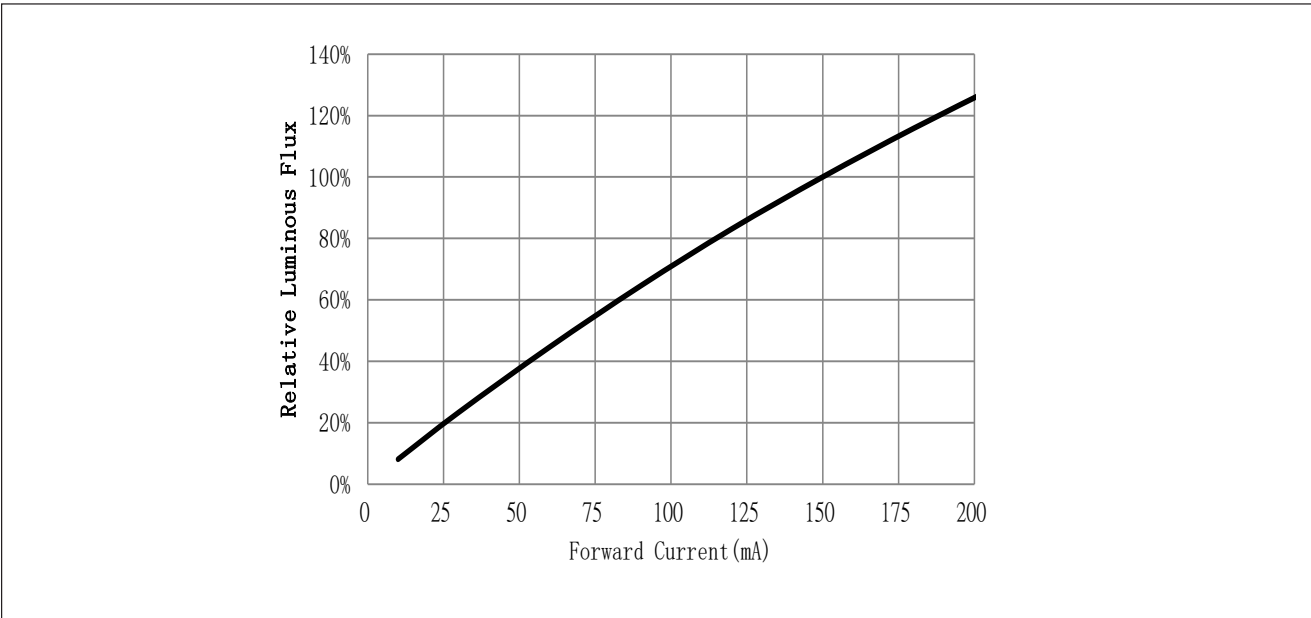

Figure 3: Typical Relative Luminous Flux vs. Forward Current ($T_{sp}=25^{\circ}\text{C}$)



Note for Figure 3:
1. Pulse width modulation (PWM) is recommended for dimming effects.

Performance Curves

Figure 4: Typical Relative Flux vs. Solder Point Temperature

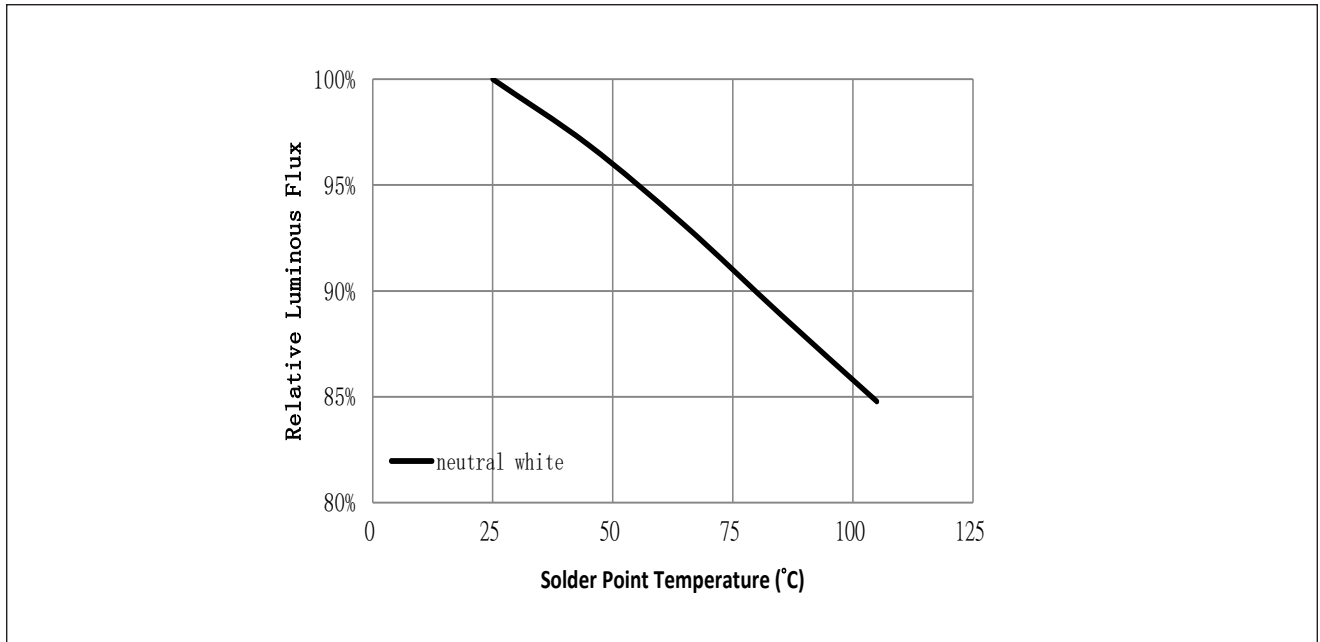
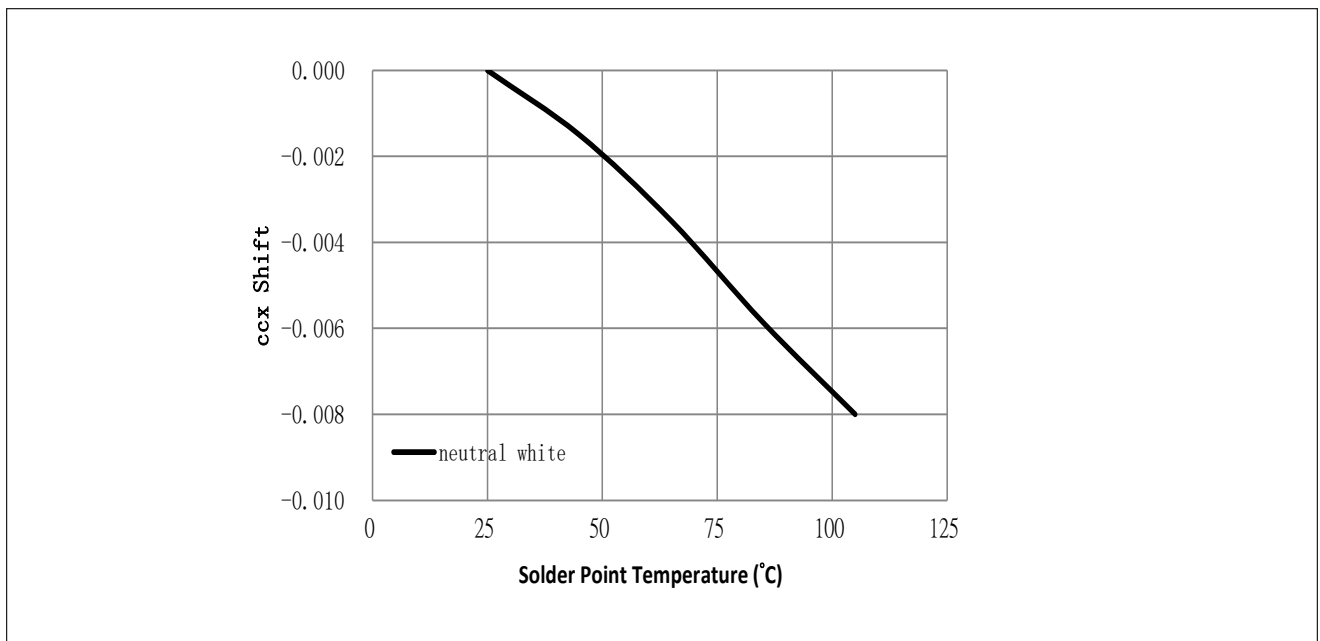

Figure 5: Typical ccx Shift vs. Solder Point Temperature



Notes for Figures 4 & 5:

1. Characteristics shown for neutral white based on 4000K and 80 CRI.
2. For other color SKUs, the shift in color will vary. Please contact your Bridgelux Sales Representative for more information

Performance Curves

Figure 6: Typical ccy Shift vs. Solder Point Temperature

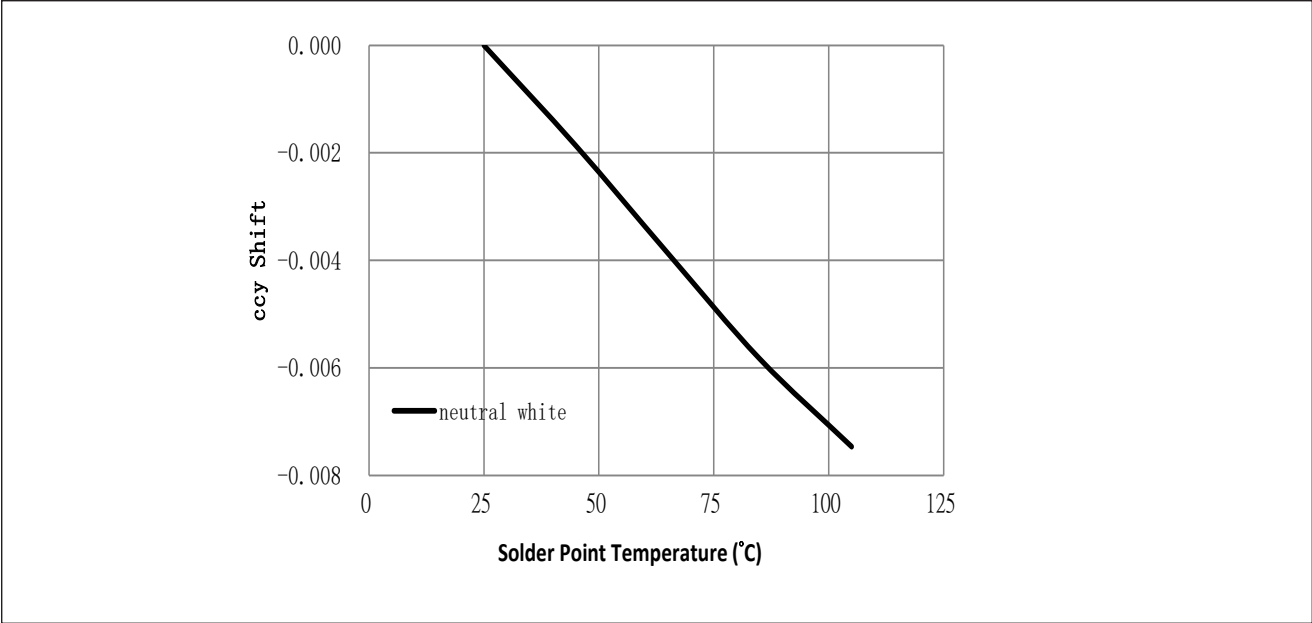

Notes for Figure 6:

- 1. Characteristics shown for neutral white based on 4000K and 80 CRI.
- 2. For other color SKUs, the shift in color will vary. Please contact your Bridgelux Sales Representative for more information.

Typical Radiation Pattern

Figure 7: Typical Spatial Radiation Pattern at 150mA, $T_{sp}=25^{\circ}\text{C}$

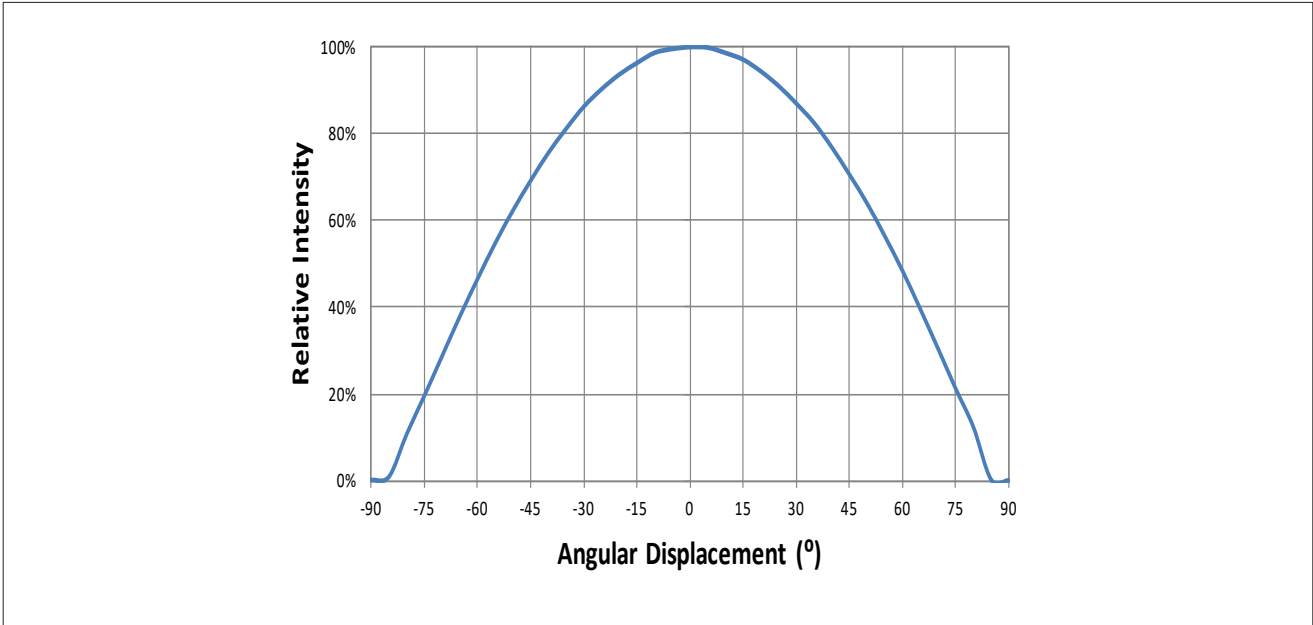

Notes for Figure 7:

- 1. Typical viewing angle is 120°.
- 2. The viewing angle is defined as the off axis angle from the centerline where luminous intensity (Iv) is 1/2 of the peak value.

Figure 8: Typical Polar Radiation Pattern at 150mA, $T_{sp}=25^{\circ}\text{C}$

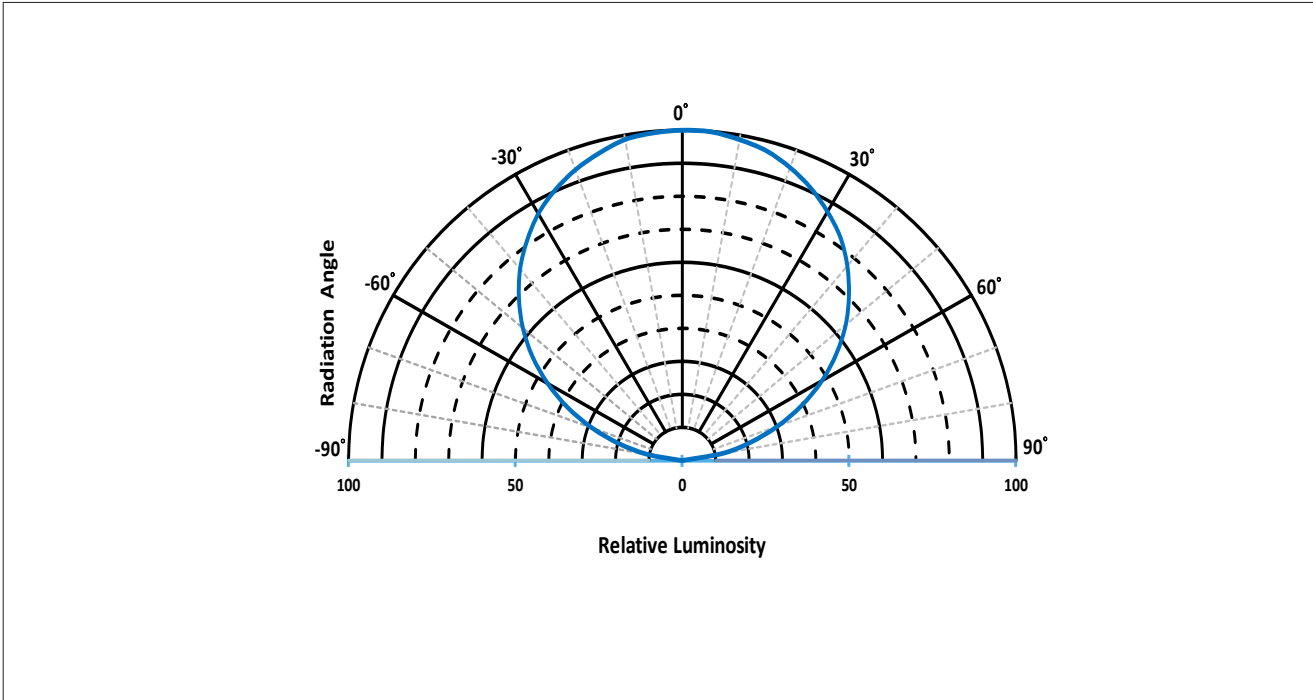

Typical Color Spectrum

Figure 9: Typical Color Spectrum

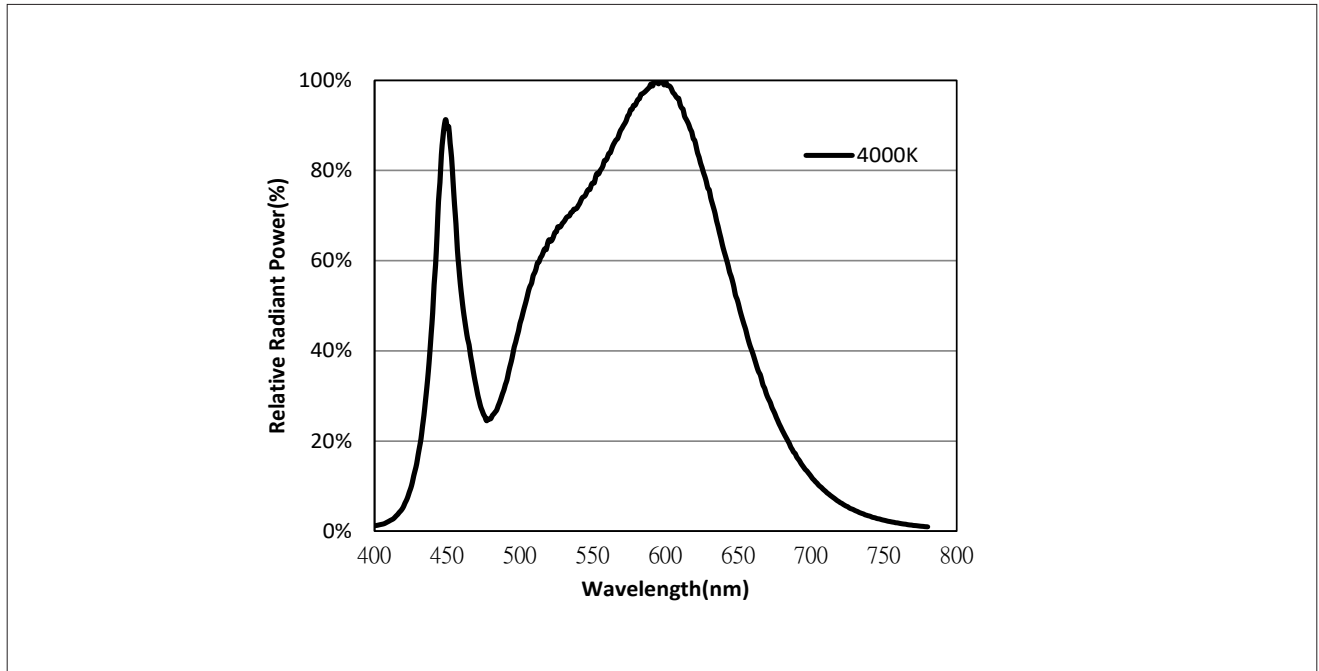

Notes for Figure 9:

1. Color spectra measured at nominal current for $T_{sp} = 25^{\circ}\text{C}$
2. Color spectra shown for 80 CRI products.

Mechanical Dimensions

Figure 10: Drawing for SMD 2835

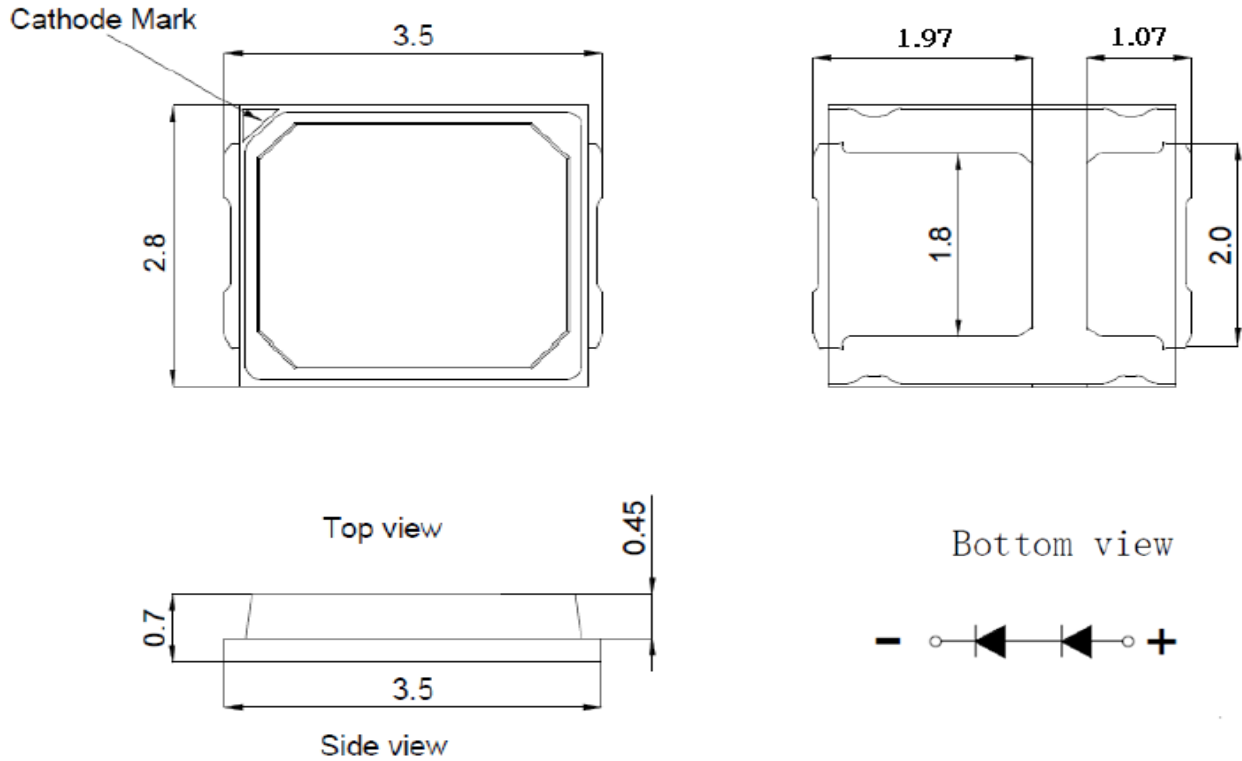

Notes for Figure 10:

1. Drawings are not to scale.
2. Drawing dimensions are in millimeters.
3. Unless otherwise specified, tolerances are $\pm 0.10\text{mm}$.

Recommended PCB Soldering Pad Pattern

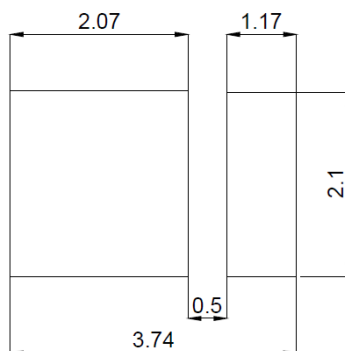

Reliability

Table 8: Reliability Test Items and Conditions

| No. | Items | Reference Standard | Test Conditions | Drive Current | Test Duration | Units Failed/Tested |
|-----|-------------------------------------|--------------------|---|---------------|---------------|---------------------|
| 1 | Moisture/Reflow Sensitivity | J-STD-020E | $T_{\text{reflow}} = 260^{\circ}\text{C}$, 10sec. Precondition: 60°C , 60%RH, 168hr | - | 3 reflows | 0/20 |
| 2 | Low Temperature Storage | JESD22-A119 | $T_{\text{a}} = -40^{\circ}\text{C}$ | - | 1000 hours | 0/20 |
| 3 | High Temperature Storage | JESD22-A103D | $T_{\text{a}} = 105^{\circ}\text{C}$ | - | 1000 hours | 0/20 |
| 4 | Low Temperature Operating Life | JESD22-A108D | $T_{\text{a}} = -40^{\circ}\text{C}$ | 150mA | 1000 hours | 0/20 |
| 5 | Temperature Humidity Operating Life | JESD22-A101C | $T_{\text{sp}} = 85^{\circ}\text{C}$, RH=85% | 150mA | 1000 hours | 0/20 |
| 6 | High Temperature Operating Life | JESD22-A108D | $T_{\text{sp}} = 105^{\circ}\text{C}$ | 180mA | 1000 hours | 0/20 |
| 7 | Power switching | IEC62717:2014 | $T_{\text{sp}} = 105^{\circ}\text{C}$ 30 sec on, 30 sec off | 180mA | 30000 cycles | 0/20 |
| 8 | Thermal Shock | JESD22-A106B | $T_{\text{a}} = -40^{\circ}\text{C} \sim 100^{\circ}\text{C}$; Dwell : 15min; Transfer: 10sec | - | 200 cycles | 0/20 |
| 9 | Temperature Cycle | JESD22-A104E | $T_{\text{a}} = -40^{\circ}\text{C} \sim 100^{\circ}\text{C}$; Dwell at extreme temperature: 15min; Ramp rate < $105^{\circ}\text{C}/\text{min}$ | - | 200 cycles | 0/20 |
| 10 | Electrostatic Discharge | JS-001-2012 | HBM, 2kV, 15k Ω , 100pF. Alternately positive or negative | - | - | 0/20 |

Passing Criteria

| Item | Symbol | Test Condition | Passing Criteria |
|--------------------------|--------|----------------|-----------------------|
| Forward Voltage | Vf | 150mA | $\Delta V_f < 10\%$ |
| Luminous Flux | Fv | 150mA | $\Delta F_v < 30\%$ |
| Chromaticity Coordinates | (x, y) | 150mA | $\Delta u'v' < 0.007$ |

Notes for Table 8:

- Measurements are performed after allowing the LEDs to return to room temperature
- T_{reflow} : reflow soldering temperature; T_{a} : ambient temperature

Reflow Characteristics

Figure 11 : Reflow Profile (Reflow frequency 2 times max)

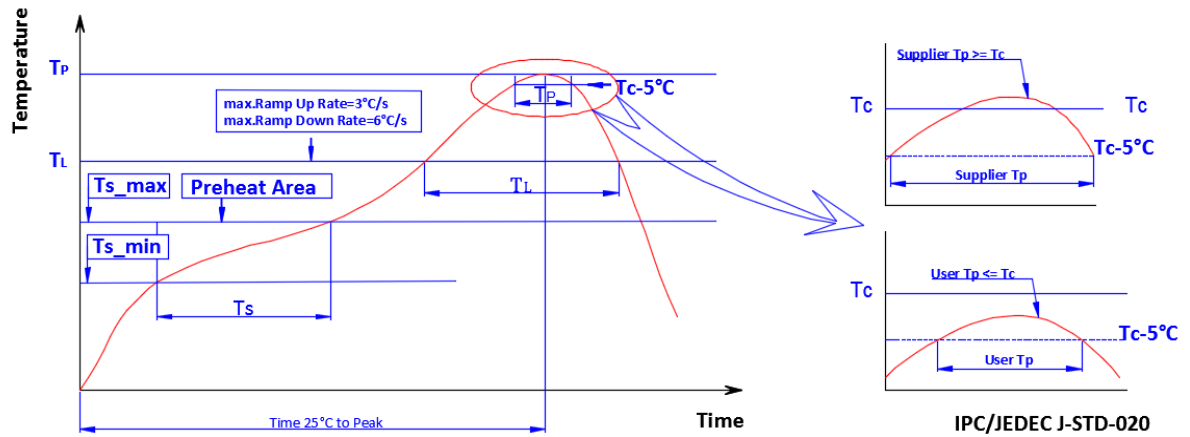

| Profile Feature | Lead Free Assembly |
|---|--------------------------------|
| Temperature Min. (T_{s_min}) | 160°C |
| Temperature Max. (T_{s_max}) | 205°C |
| Time (ts) from T_{s_min} to T_{s_max} | 60-150 seconds |
| Ramp-Up Rate (TL to T_p) | 3°C/second |
| Liquidus Temperature (TL) | 220°C |
| Time (TL) Maintained Above TL | 60-150 seconds |
| Peak Temp(T_p) | 260°C max 10 sec |
| Time (T_p) Within 5°C of the Specified Classification Temperature (T_c) | 25 seconds max. |
| Ramp-Down Rate (T_p to TL) | 5°C/second max. |
| Time 25°C to Peak Temperature | 10 minutes max. |

Packaging

Figure 14: Emitter Reel Packaging Drawings

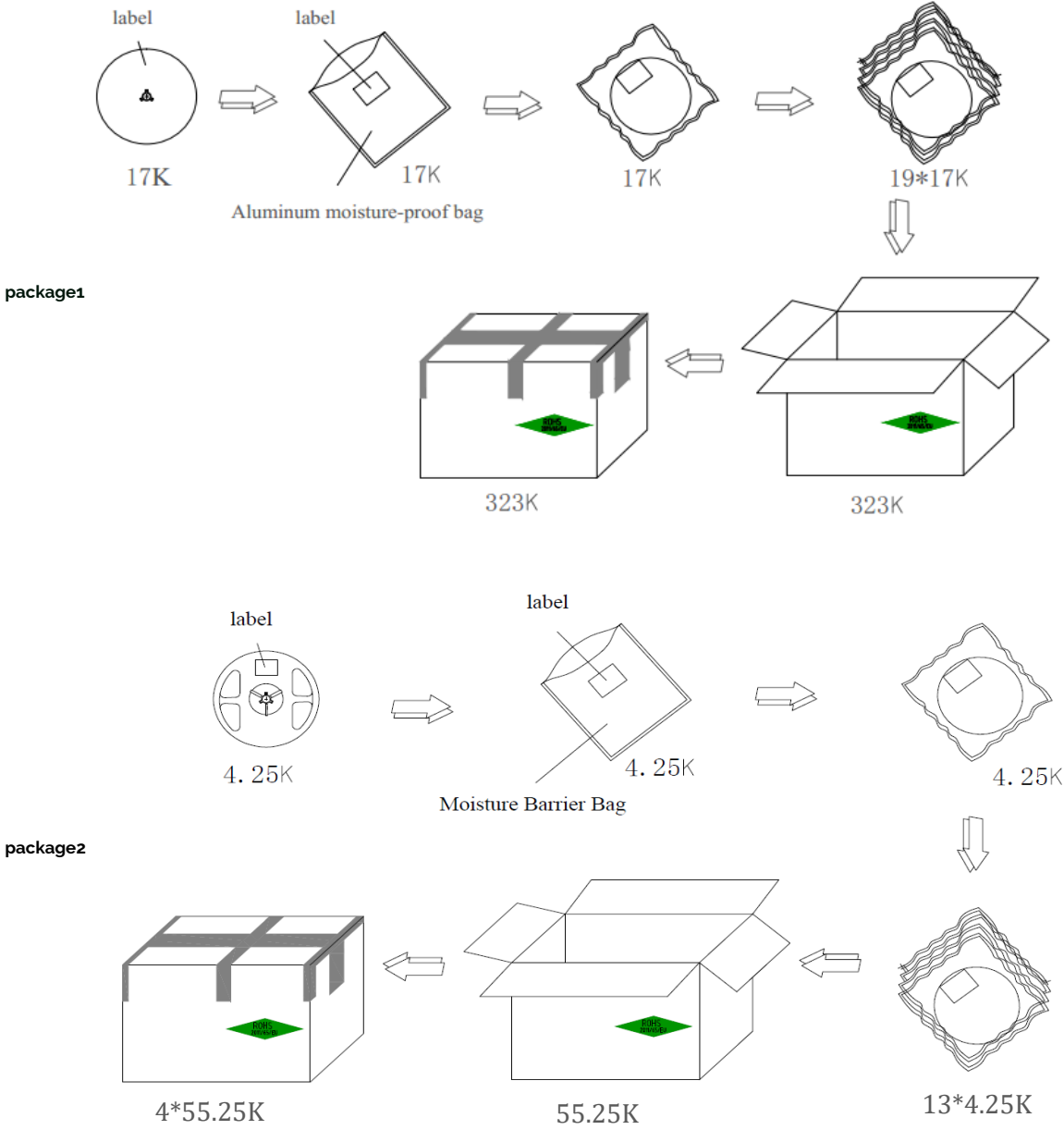

Note for Figure 14:
 1. Drawings are not to scale.

Design Resources

Please contact your Bridgelux sales representative for assistance.

Precautions

CAUTION: CHEMICAL EXPOSURE HAZARD

Exposure to some chemicals commonly used in luminaire manufacturing and assembly can cause damage to the LED emitter. Please consult Bridgelux Application Note AN51 for additional information.

CAUTION: EYE SAFETY

Eye safety classification for the use of Bridgelux SMD LED emitter is in accordance with IEC specification EN62471: Photobiological Safety of Lamps and Lamp Systems. SMD LED emitters are classified as Risk Group 1 when operated at or below the maximum drive current. Please use appropriate precautions. It is important that employees working with LEDs are trained to use them safely.

CAUTION: RISK OF BURN

Do not touch the SMD LED emitter during operation. Allow the emitter to cool for a sufficient period of time before handling. The SMD LED emitter may reach elevated temperatures such that could burn skin when touched.

CAUTION

CONTACT WITH LIGHT EMITTING SURFACE (LES)

Avoid any contact with the LES. Do not touch the LES of the emitter or apply stress to the LES (yellow phosphor resin area). Contact may cause damage to the emitter

Optics and reflectors must not be mounted in contact with the LES (yellow phosphor resin area).

Disclaimers

MINOR PRODUCT CHANGE POLICY

The rigorous qualification testing on products offered by Bridgelux provides performance assurance. Slight cosmetic changes that do not affect form, fit, or function may occur as Bridgelux continues product optimization.

STANDARD TEST CONDITIONS

Unless otherwise stated, LED emitter testing is performed at the nominal drive current.

About Bridgelux: Bridging Light and Life™

At Bridgelux, we help companies, industries and people experience the power and possibility of light. Since 2002, we've designed LED solutions that are high performing, energy efficient, cost effective and easy to integrate. Our focus is on light's impact on human behavior, delivering products that create better environments, experiences and returns—both experiential and financial. And our patented technology drives new platforms for commercial and industrial luminaires.

For more information about the company, please visit
bridgelux.com
twitter.com/Bridgelux
facebook.com/Bridgelux
youtube.com/user/Bridgelux
WeChat ID: BridgeluxInChina
https://www.linkedin.com/company/bridgelux-inc-_2



46410 Fremont Boulevard
Fremont, CA 94538 USA
Tel (925) 583-8400
Fax (925) 583-8401
www.bridgelux.com

© 2024 Bridgelux, Inc. All rights reserved 2024. Product specifications are subject to change without notice. Bridgelux and the Bridgelux stylized logo design are registered trademarks of Bridgelux, Inc. All other trademarks are the property of their respective owners.