

Bridgelux® SMD 2835 0.2W 3V

Product Data Sheet DS520

Introduction

SMD 2835



Features

- Industry-standard 2835 footprint
- Cold-color targeting ensures that color is within the ANSI bin at the typical application conditions of 25°C
- RoHS compliant and lead free
- Multiple CCT configurations for a wide range of lighting applications

Benefits

- Lower operating and manufacturing cost
- Ease of design and rapid go-to-market
- Uniform, consistent white light
- Reliable and constant white point
- Compliant with environmental standards
- Design flexibility

Contents

Product Feature Map	2
Product Nomenclature	2
Product Selection Guide	3
Electrical Characteristics	4
Absolute Maximum Ratings	5
Product Bin Definitions	6
Performance Curves	9
Typical Radiation Pattern	12
Typical Color Spectrum	13
Mechanical Dimensions	14
Reliability	15
Reflow Characteristics	16
Packaging	17
Design Resources	19
Precautions	19
Disclaimers	19
About Bridgelux	20

Product Selection Guide

The following product configurations are available:

Table 1: Selection Guide, Pulsed Measurement Data at 65mA ($T_j = T_{sp} = 25^\circ\text{C}$)

Part Number ^{2,6}	Nominal CCT ² (K)	CRI ^{3,5}	Nominal Drive Current (mA)	Forward Voltage ^{4,5} (V)			Typical Pulsed Flux (lm) ^{4,5}	Typical Power (W)	Typical Efficacy (lm/W)	PPF (umole/s)	PPE (umol/J)
				Min	Typical	Max					
BXEN-22E-21L-3DA-00-0-0	2200	80	65	2.60	2.72	2.90	30.5	0.2	173	0.46	2.59
BXEN-27E-21L-3DA-00-0-0	2700	80	65	2.60	2.72	2.90	34.5	0.2	195	0.47	2.67
BXEN-30E-21L-3DA-00-0-0	3000	80	65	2.60	2.72	2.90	35.7	0.2	202	0.48	2.75
BXEN-35E-21L-3DA-00-0-0	3500	80	65	2.60	2.72	2.90	35.7	0.2	202	0.48	2.75
BXEN-40E-21L-3DA-00-0-0	4000	80	65	2.60	2.72	2.90	37.5	0.2	212	0.51	2.90
BXEN-50E-21L-3DA-00-0-0	5000	80	65	2.60	2.72	2.90	37.5	0.2	212	0.51	2.90
BXEN-57E-21L-3DA-00-0-0	5700	80	65	2.60	2.72	2.90	37.2	0.2	210	0.51	2.90
BXEN-65E-21L-3DA-00-0-0	6500	80	65	2.60	2.72	2.90	37.2	0.2	210	0.51	2.90
BXEN-66B-21L-3DA-00-0-0	6600	67	65	2.60	2.72	2.90	39.8	0.2	225	0.52	2.93
BXEN-75B-21L-3DA-00-0-0	7500	57	65	2.60	2.72	2.90	39.8	0.2	225	0.52	2.93

Table 2: Selection Guide, Pulsed Test Performance ($T_{sp} = 85^\circ\text{C}$)

Part Number ^{2,6}	Nominal CCT ² (K)	CRI ^{3,5}	Nominal Drive Current (mA)	Forward Voltage ^{4,5} (V)			Typical Pulsed Flux (lm) ^{4,5}	Typical Power (W)	Typical Efficacy (lm/W)	PPF (umole/s)	PPE (umol/J)
				Min	Typical	Max					
BXEN-22E-21L-3DA-00-0-0	2200	80	65	2.54	2.66	2.84	28.0	0.2	162	0.44	2.51
BXEN-27E-21L-3DA-00-0-0	2700	80	65	2.54	2.66	2.84	31.7	0.2	183	0.45	2.59
BXEN-30E-21L-3DA-00-0-0	3000	80	65	2.54	2.66	2.84	32.8	0.2	190	0.46	2.63
BXEN-35E-21L-3DA-00-0-0	3500	80	65	2.54	2.66	2.84	32.8	0.2	190	0.46	2.63
BXEN-40E-21L-3DA-00-0-0	4000	80	65	2.54	2.66	2.84	34.4	0.2	199	0.49	2.78
BXEN-50E-21L-3DA-00-0-0	5000	80	65	2.54	2.66	2.84	34.4	0.2	199	0.49	2.78
BXEN-57E-21L-3DA-00-0-0	5700	80	65	2.54	2.66	2.84	34.1	0.2	197	0.49	2.78
BXEN-65E-21L-3DA-00-0-0	6500	80	65	2.54	2.66	2.84	34.1	0.2	197	0.49	2.78
BXEN-66B-21L-3DA-00-0-0	6600	67	65	2.54	2.66	2.84	36.5	0.2	211	0.50	2.81
BXEN-75B-21L-3DA-00-0-0	7500	57	65	2.54	2.66	2.84	36.5	0.2	211	0.50	2.81

Notes for Tables 1 & 2:

- The last 6 characters (including hyphens '-') refer to flux bins, forward voltage bins, and color bin options, respectively. "00-0-0" denotes the full distribution of flux, forward voltage, and color bin.
Example: BXEN-30E-21L-3DA-00-0-0 refers to the full distribution of flux, forward voltage, and color within a 3000K 6-step ANSI standard chromaticity region with a minimum of 80 CRI, and 6600k typical of 67 CRI, 7500k typical of 57 CRI, 2x1 die configuration, low power, 2.72V typical forward voltage.
- Product CCT is cold targeted at $T_{sp} = 25^\circ\text{C}$. Nominal CCT as defined by ANSI C78.377-2011.
- Listed CRIs are minimum values and include test tolerance.
- Products tested under pulsed condition (10ms pulse width) at nominal drive current.
- Bridgelux maintains a $\pm 7.5\%$ tolerance on luminous flux measurements, $\pm 0.1\text{V}$ tolerance on forward voltage measurements, and ± 2 tolerance on CRI measurements for the SMD 2835.
- Refer to Table 5 and Table 6 for Bridgelux SMD 2835 Luminous efficacy Binning and Forward Voltage Binning information.
- Typical pulsed test performance values are provided as reference only and are not a guarantee of performance.
- Typical performance is estimated based on operation under pulsed current with LED emitter mounted onto a heat sink with thermal interface material and the solder point temperature maintained at 25°C . Based on Bridgelux test setup, values may vary depending on the thermal design of the luminaire and the exposed environment to which the product is subjected.

Electrical Characteristics

Table 3: Electrical Characteristics

Part Number	Drive Current (mA)	Forward Voltage (V) ^{1,2}			Typical Temperature Coefficient of Forward Voltage $\Delta V_f / \Delta T$ (mV/°C)	Typical Thermal Resistance Junction to Solder Point ³ R_{j-sp} (°C/W)
		Minimum	Typical	Maximum		
BXEN-XXX-21L-3DA-00-0-0	65	2.60	2.72	2.90	-1.03	12.4

Notes for Table 3:

1. Bridgelux maintains a tolerance of $\pm 0.1V$ on forward voltage measurements. Voltage minimum and maximum values at the nominal drive current are guaranteed by 100% test.
2. Products tested under pulsed condition (10ms pulse width) at nominal drive current where $T_{sp} = 25^{\circ}C$.
3. Thermal resistance value was calculated using total electrical input power; optical power was not subtracted from input power.

Absolute Maximum Ratings

Table 4: Maximum Ratings

Parameter	Maximum Rating
LED Junction Temperature (T_j)	125°C
Storage Temperature	-40°C to +105°C
Operating Solder Point Temperature (T_{sp})	-40°C to +105°C
Soldering Temperature	260°C or lower for a maximum of 10 seconds
Maximum Drive Current	400mA
Maximum Peak Pulsed Forward Current ¹	600mA
Maximum Reverse Voltage ²	-
Moisture Sensitivity Rating	MSL 3
Electrostatic Discharge	2kV HBM. JEDEC-JS-001-HBM and JEDEC-JS-001-2012

Notes for Table 4:

1. Bridgelux recommends a maximum duty cycle of 10% and pulse width of 10 ms when operating LED SMD at maximum peak pulsed current specified. Maximum peak pulsed current indicate values where LED SMD can be driven without catastrophic failures.
2. Light emitting diodes are not designed to be driven in reverse voltage and will not produce light under this condition. no rating is provided.

Product Bin Definitions

Table 5 lists the standard photometric luminous efficacy bins for Bridgelux SMD 2835 LEDs. Although several bins are listed, product availability in a particular bin varies by production run and by product performance. Not all bins are available in all CCTs.

Table 5: Efficacy Bin Definitions at 65mA, $T_{sp}=25^{\circ}\text{C}$

Bin Code	Minimum	Maximum	Unit	Condition
N8	170	180	lm/w	$I_F=65\text{mA}$
N9	180	190		
MA	190	205		
MB	205	220		
MC	220	235		

Note for Table 5:

1. Bridgelux maintains a tolerance of $\pm 7.5\%$ on luminous efficacy measurements.

Table 6: Forward Voltage Bin Definition at 65mA, $T_{sp}=25^{\circ}\text{C}$

Bin Code	Minimum	Maximum	Unit	Condition
8	2.6	2.7	V	$I_F=65\text{mA}$
9	2.7	2.8		
A	2.8	2.9		

Note for Table 6:

1. Bridgelux maintains a tolerance of $\pm 0.1\text{V}$ on forward voltage measurements.

Product Bin Definitions

Table 7: MacAdam Ellipse Color Bin Definitions

CCT	Color Space	Center Point		Major Axis	Minor Axis	Ellipse Rotation Angle	Color Bin
		X	Y				
2200K	3 SDCM	0.5018	0.4153	0.0086	0.0040	49.27	1
	6 SDCM	0.5018	0.4153	0.0173	0.0080	49.27	1/A/B/C/D
2700K	3 SDCM	0.4578	0.4101	0.0081	0.0042	53.70	1
	6 SDCM	0.4578	0.4101	0.0162	0.0084	53.70	1/A/B/C/D
3000K	3 SDCM	0.4338	0.4030	0.00834	0.00408	53.22	1
	6 SDCM	0.4338	0.4030	0.01668	0.00816	53.22	1/A/B/C/D
3500K	3 SDCM	0.4078	0.3930	0.00834	0.00408	54.00	1
	6 SDCM	0.4078	0.3930	0.01668	0.00816	54.00	1/A/B/C/D
4000K	3 SDCM	0.3818	0.3797	0.0094	0.0040	53.72	1
	6 SDCM	0.3818	0.3797	0.01878	0.00804	53.72	1/A/B/C/D
5000K	3 SDCM	0.3447	0.3553	0.0082	0.0035	59.62	1
	6 SDCM	0.3447	0.3553	0.01644	0.00708	59.62	1/A/B/C/D
5700K	3 SDCM	0.3287	0.3417	0.0075	0.0032	58.6	1
	6 SDCM	0.3287	0.3417	0.01492	0.00640	58.6	1/A/B/C/D
6500K	3 SDCM	0.3123	0.3282	0.0067	0.0029	58.6	1
	6 SDCM	0.3123	0.3282	0.01338	0.0057	58.6	1/A/B/C/D
6600K	3 SDCM	0.3073	0.3481	0.00669	0.00285	58.57	1
	6 SDCM	0.3073	0.3481	0.01338	0.00570	58.57	1/A/B/C/D
7500K	3 SDCM	0.2755	0.3994	0.00669	0.00285	58.57	1
	6 SDCM	0.2755	0.3994	0.01338	0.00570	58.57	1/A/B/C/D

Notes for Table 7:

1. Color binning at $T_{sp}=25^{\circ}\text{C}$ unless otherwise specified
2. Bridgelux maintains a tolerance of ± 0.007 on x and y color coordinates in the CIE 1931 color space.

Product Bin Definitions

Figure 1: C.I.E. 1931 Chromaticity Diagram (Cold-color Targeted at $T_{sp}=25^{\circ}\text{C}$)

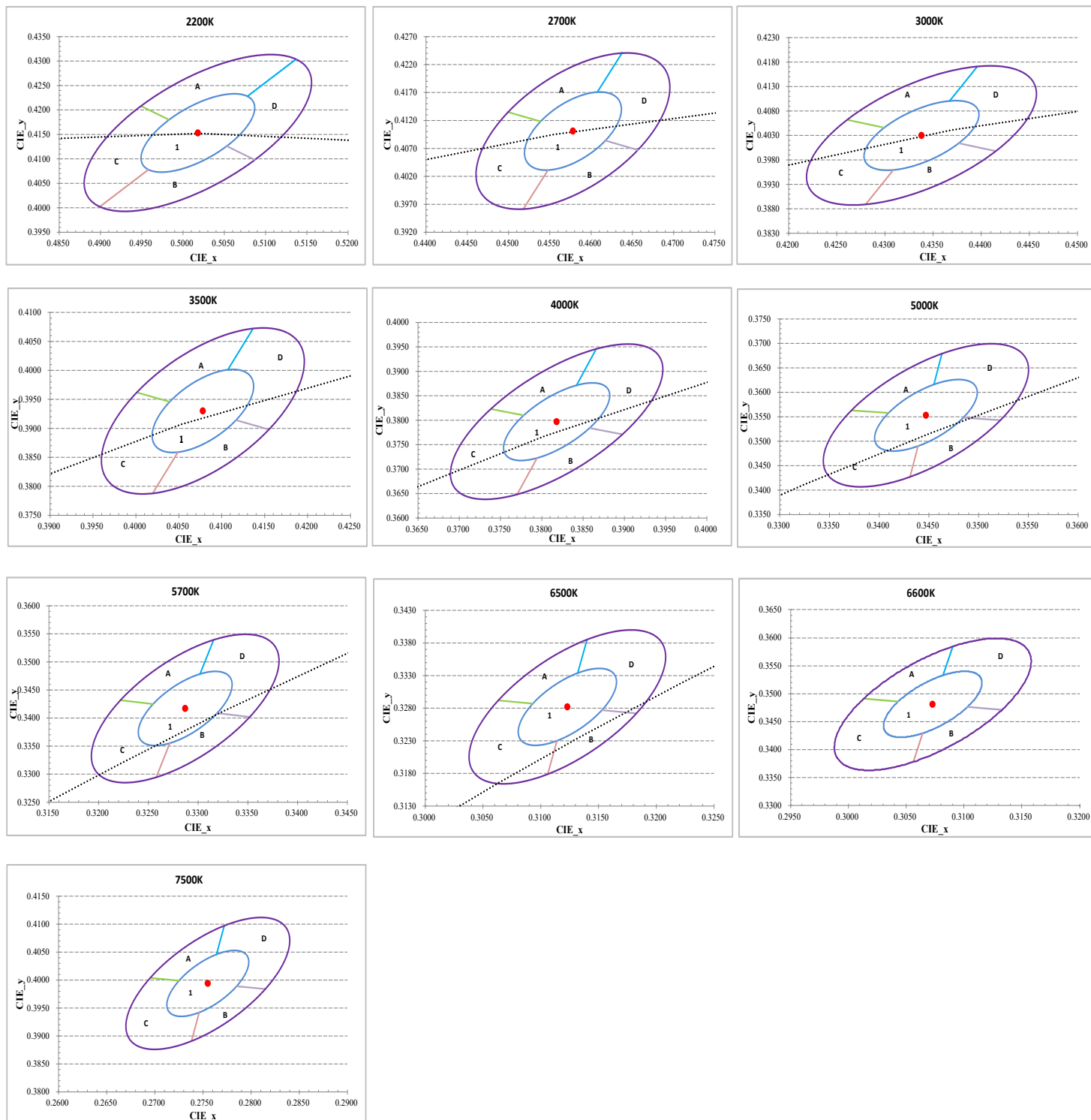

Performance Curves

Figure 2: Drive Current vs. Forward Voltage ($T_{sp}=25^{\circ}\text{C}$)

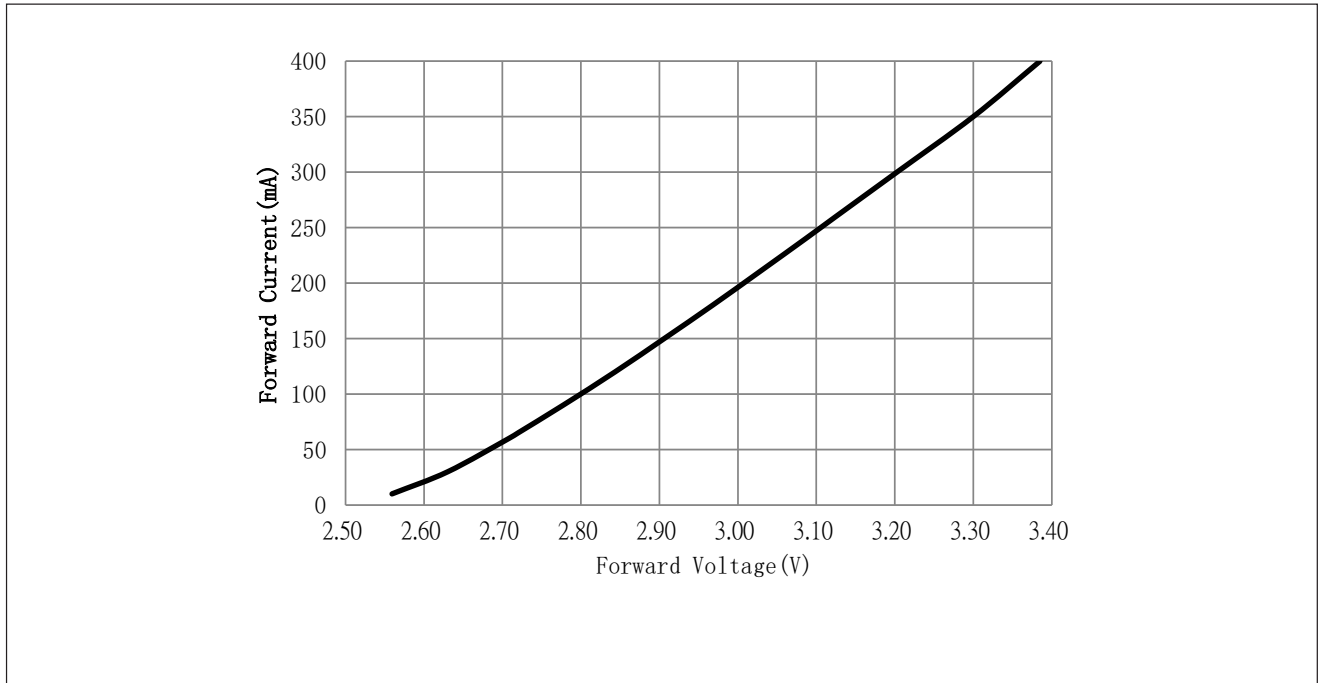
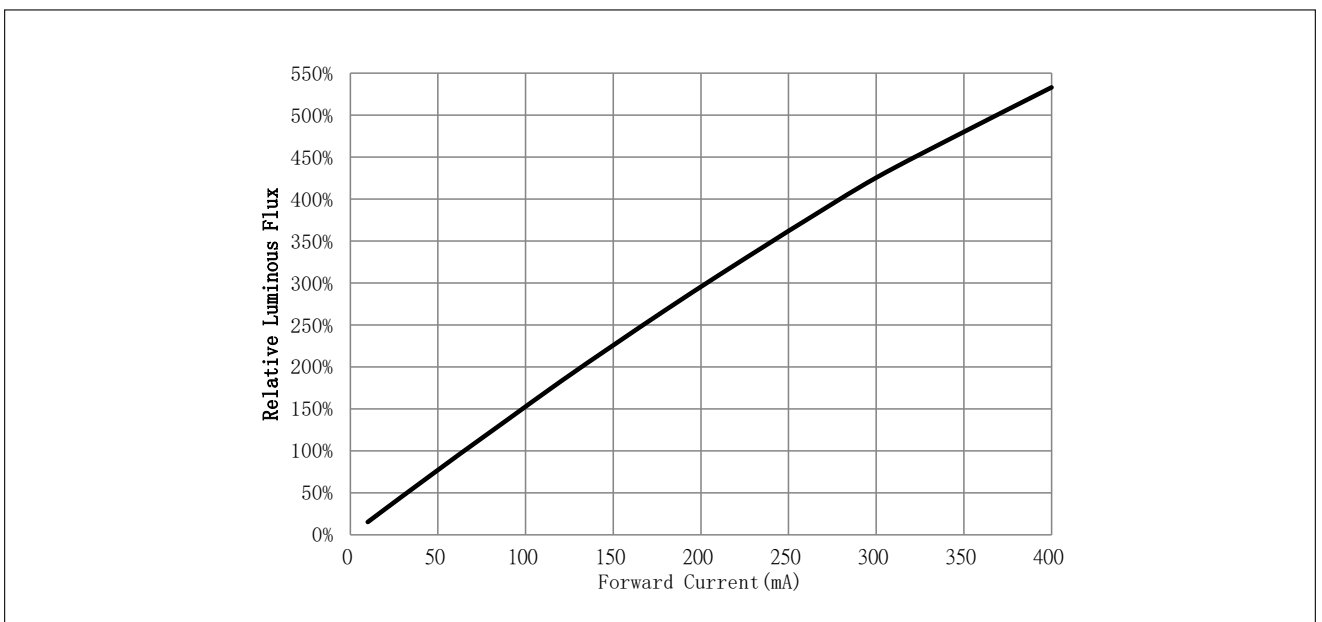

Figure 3: Relative Luminous Flux vs. Forward Current ($T_{sp}=25^{\circ}\text{C}$)



Note for Figure 3:

1. Pulse width modulation (PWM) is recommended for dimming effects.

Performance Curves

Figure 4: Relative Flux vs. Solder Point Temperature

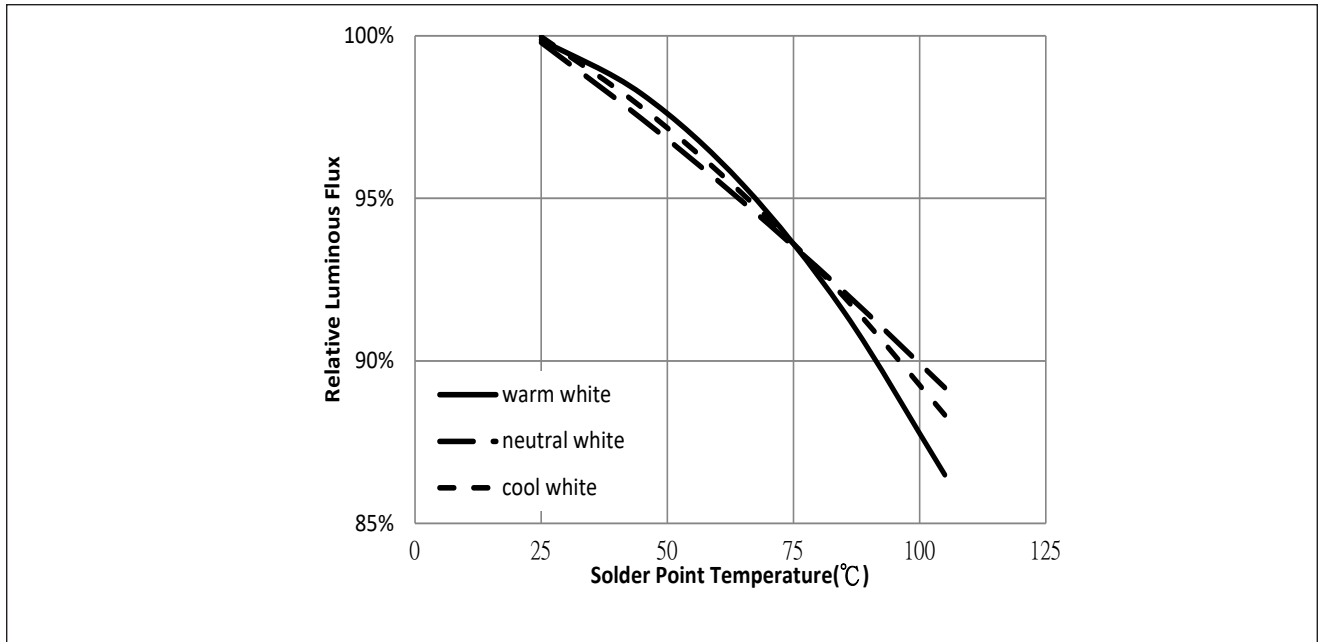
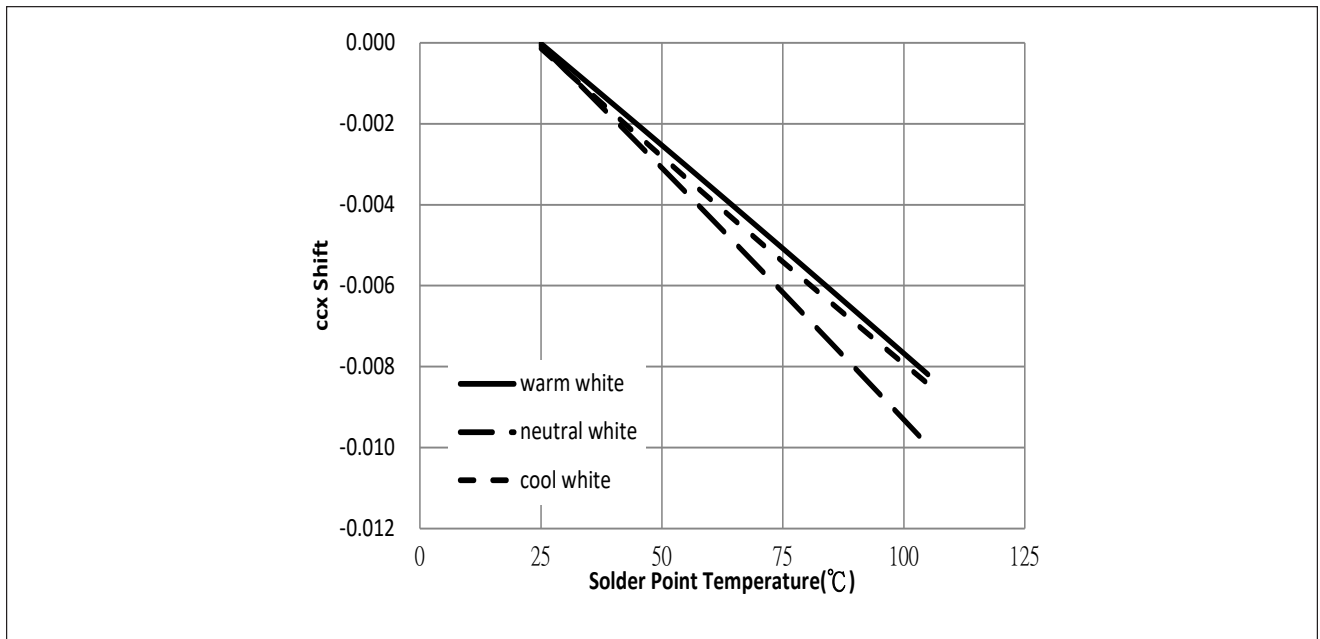

Figure 5: Typical ccx Shift vs. Solder Point Temperature



Notes for Figures 4 & 5:

1. Characteristics shown for warm white based on 3000K and 80 CRI.
2. Characteristics shown for neutral white based on 4000K and 80 CRI.
3. Characteristics shown for cool white based on 5000K and 80 CRI.
4. For other color SKUs, the shift in color will vary. Please contact your Bridgelux Sales Representative for more information.

Performance Curves

Figure 6: Typical ccy Shift vs. Solder Point Temperature

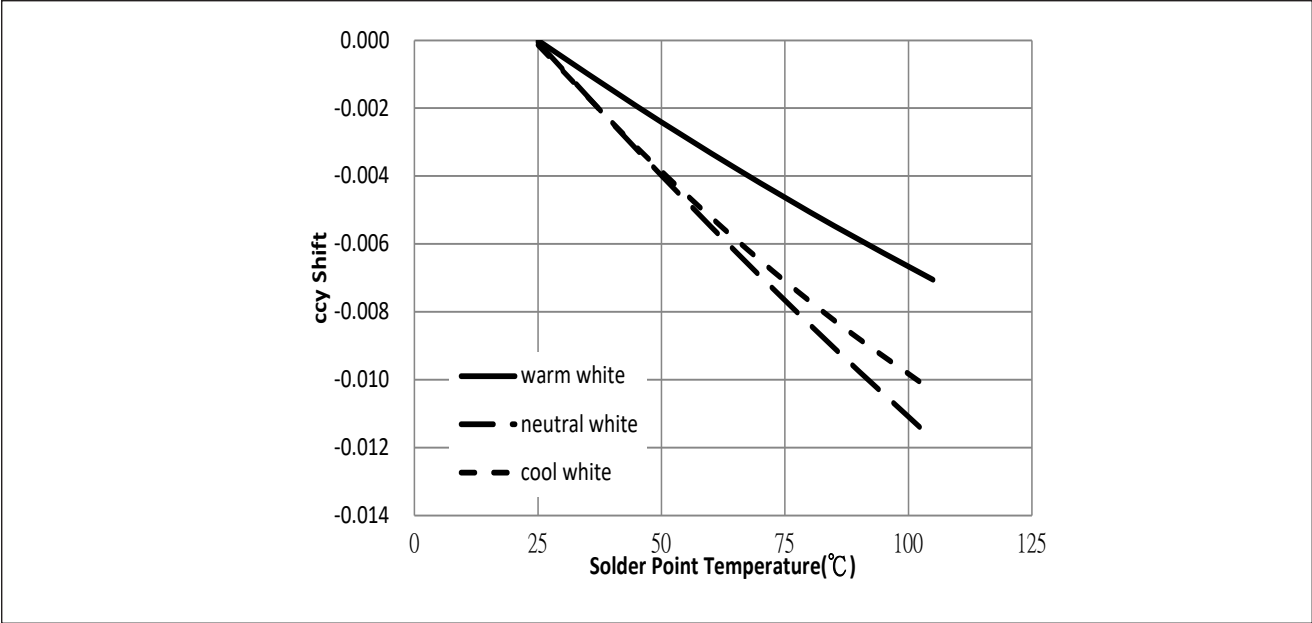

Notes for Figure 6:

- 1. Characteristics shown for warm white based on 3000K and 80 CRI.
- 2. Characteristics shown for neutral white based on 4000K and 80 CRI.
- 3. Characteristics shown for cool white based on 5000K and 80 CRI.
- 4. For other color SKUs, the shift in color will vary. Please contact your Bridgelux Sales Representative for more information.

Typical Radiation Pattern

Figure 7: Typical Spatial Radiation Pattern at 65mA, T_{sp}=25°C

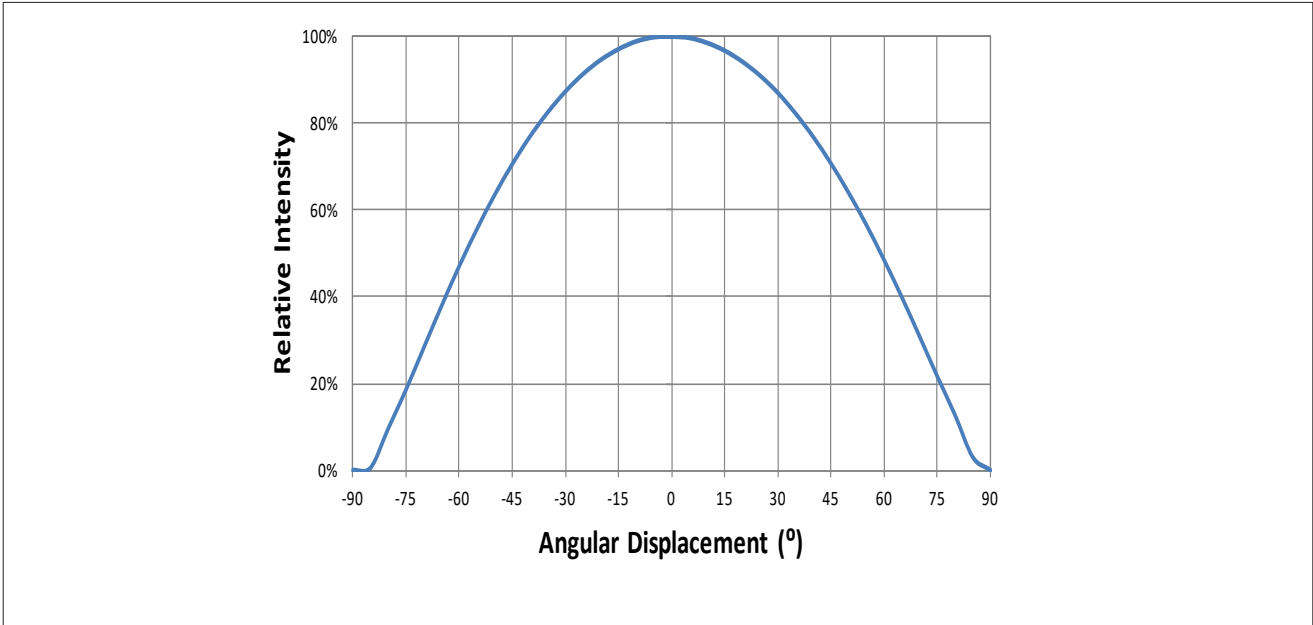

Notes for Figure 7:

- 1. Typical viewing angle is 120°.
- 2. The viewing angle is defined as the off axis angle from the centerline where luminous intensity (Iv) is 1/2 of the peak value.

Figure 8: Typical Polar Radiation Pattern at 65mA, T_{sp}=25°C

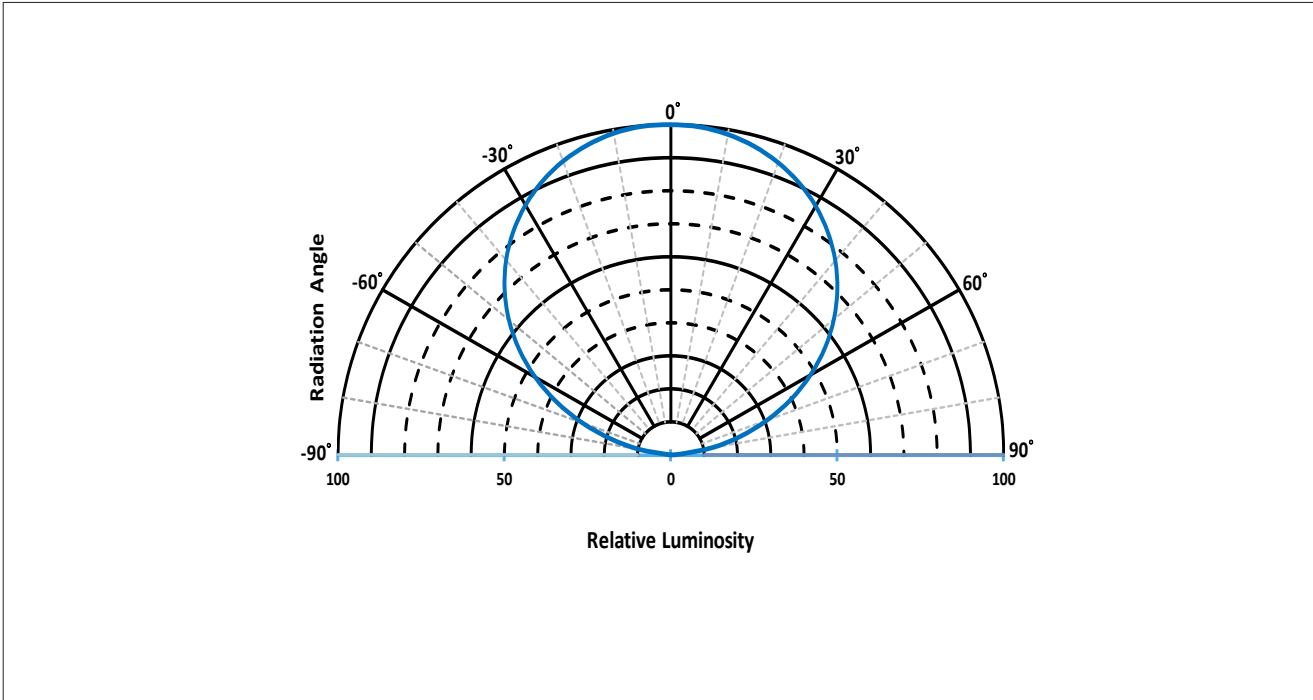

Typical Color Spectrum

Figure 9: Typical Color Spectrum

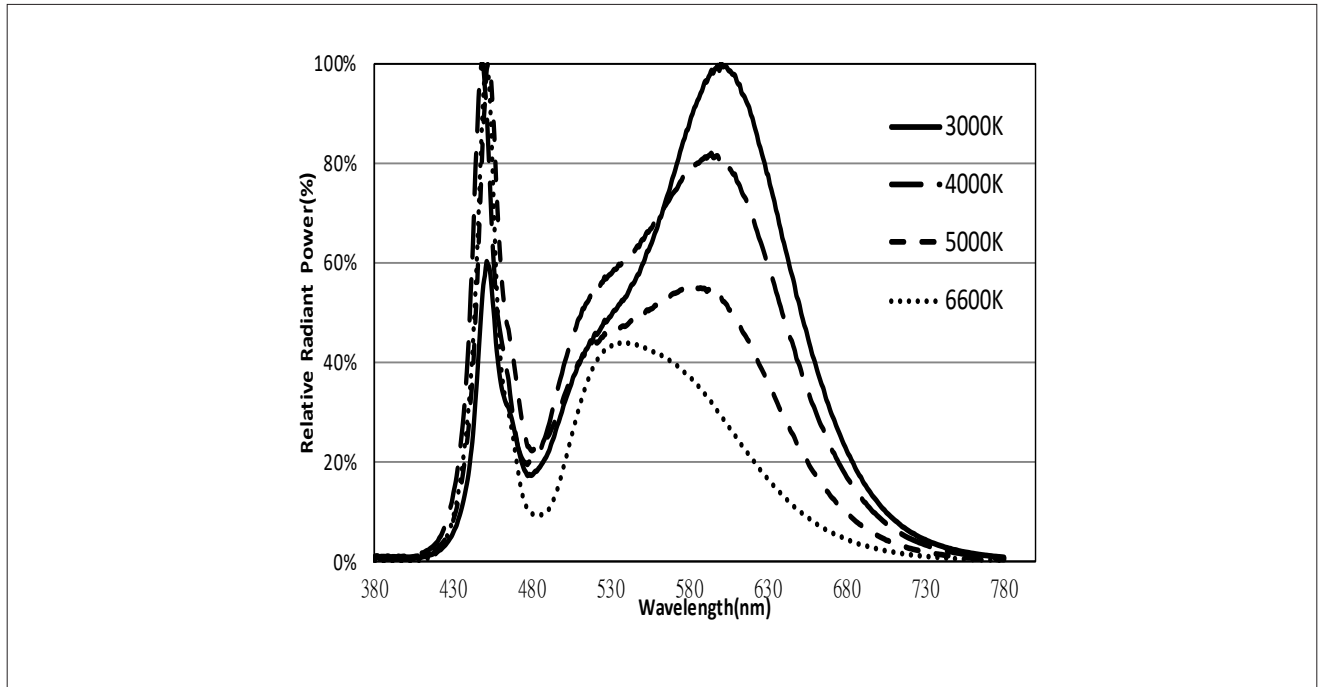

Notes for Figure 9:

1. Color spectra measured at nominal current for $T_{sp} = 25^{\circ}\text{C}$
2. Color spectra shown for 80 CRI products . 6600K for 67 CRI product .

Mechanical Dimensions

Figure 10: Drawing for SMD 2835

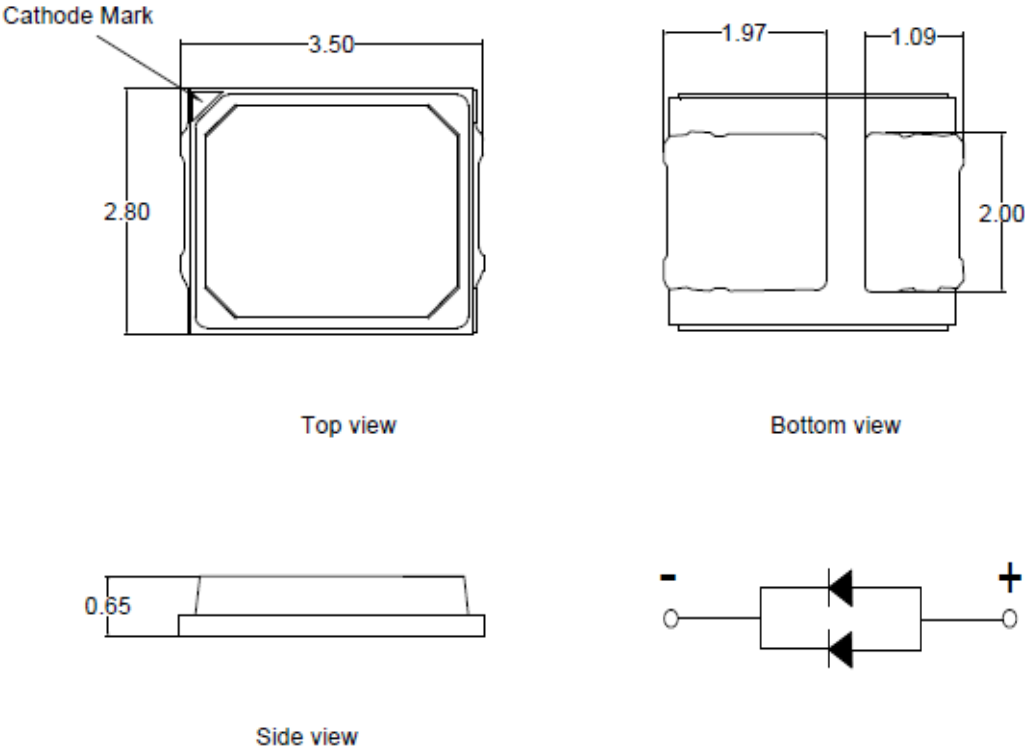

- Notes for Figure 10:
1. Drawings are not to scale.
 2. Drawing dimensions are in millimeters.
 3. Different mould pattern differences may.
 4. Unless otherwise specified, tolerances are $\pm 0.10\text{mm}$.

Recommended PCB Soldering Pad Pattern

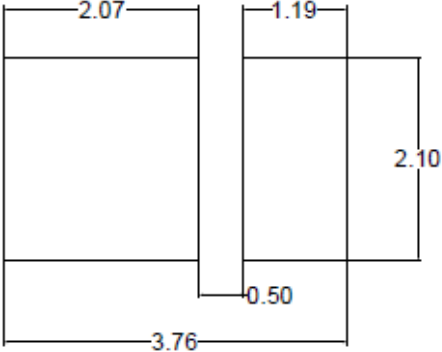

Reliability

Table 8: Reliability Test Items and Conditions

No.	Items	Reference Standard	Test Conditions	Drive Current	Test Duration	Units Failed/Tested
1	Moisture/Reflow Sensitivity	J-STD-020E	$T_{\text{slid}} = 260^{\circ}\text{C}$, 10sec. Precondition: 60°C , 30%RH, 168hr	-	3 reflows	0/20
2	Low Temperature Storage	JESD22-A119	$T_{\text{a}} = -40^{\circ}\text{C}$	-	1000 hours	0/20
3	High Temperature Storage	JESD22-A103D	$T_{\text{a}} = 100^{\circ}\text{C}$	-	1000 hours	0/20
4	Low Temperature Operating Life	JESD22-A108D	$T_{\text{a}} = -40^{\circ}\text{C}$	400mA	1000 hours	0/20
5	Temperature Humidity Operating Life	JESD22-A101C	$T_{\text{sp}} = 85^{\circ}\text{C}$, RH=85%	65mA	1000 hours	0/20
6	High Temperature Operating Life	JESD22-A108D	$T_{\text{sp}} = 105^{\circ}\text{C}$	400mA	1000 hours	0/20
7	Power switching	IEC62717:2014	$T_{\text{sp}} = 105^{\circ}\text{C}$ 30 sec on, 30 sec off	400mA	30000 cycles	0/20
8	Thermal Shock	JESD22-A106B	$T_{\text{a}} = -40^{\circ}\text{C} \sim 100^{\circ}\text{C}$; Dwell: 15min; Transfer: 10sec	-	200 cycles	0/20
9	Temperature Cycle	JESD22-A104E	$T_{\text{a}} = -40^{\circ}\text{C} \sim 100^{\circ}\text{C}$; Dwell at extreme temperature: 15min; Ramp rate $< 105^{\circ}\text{C}/\text{min}$	-	200 cycles	0/20
10	Electrostatic Discharge	JS-001-2012	HBM, 2KV, 15k Ω , 100pF. Alternately positive or negative	-	-	0/20

Passing Criteria

Item	Symbol	Test Condition	Passing Criteria
Forward Voltage	Vf	65mA	$\Delta V_f < 10\%$
Luminous Flux	Fv	65mA	$\Delta F_v < 30\%$
Chromaticity Coordinates	(x, y)	65mA	$\Delta u'v' < 0.007$

Notes for Table 8:

- Measurements are performed after allowing the LEDs to return to room temperature
- T_{slid} : reflow soldering temperature; T_{a} : ambient temperature

Reflow Characteristics

Figure 11 : Reflow Profile

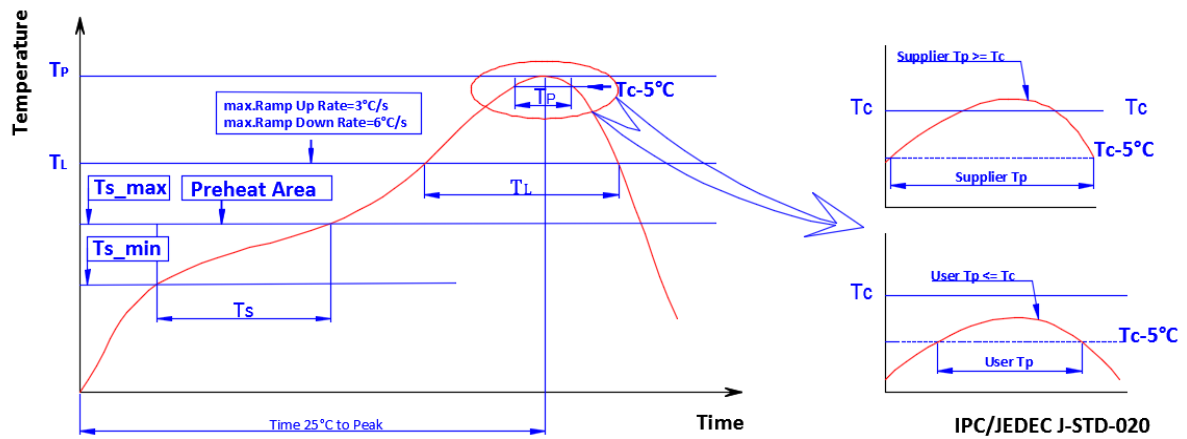

Profile Feature	Lead Free Assembly
Temperature Min. (T_{s_min})	160°C
Temperature Max. (T_{s_max})	205°C
Time (ts) from T_{s_min} to T_{s_max}	60-150 seconds
Ramp-Up Rate (TL to T_p)	3 °C/second
Liquidus Temperature (TL)	220 °C
Time (TL) Maintained Above TL	60-150 seconds
Peak Temp(T_p)	260 °C max.
Time (T_p) Within 5 °C of the Specified Classification Temperature (T_c)	25 seconds max.
Ramp-Down Rate (T_p to TL)	5 °C/second max.
Time 25 °C to Peak Temperature	10 minutes max.

Packaging

Figure 12: Emitter Reel Drawings

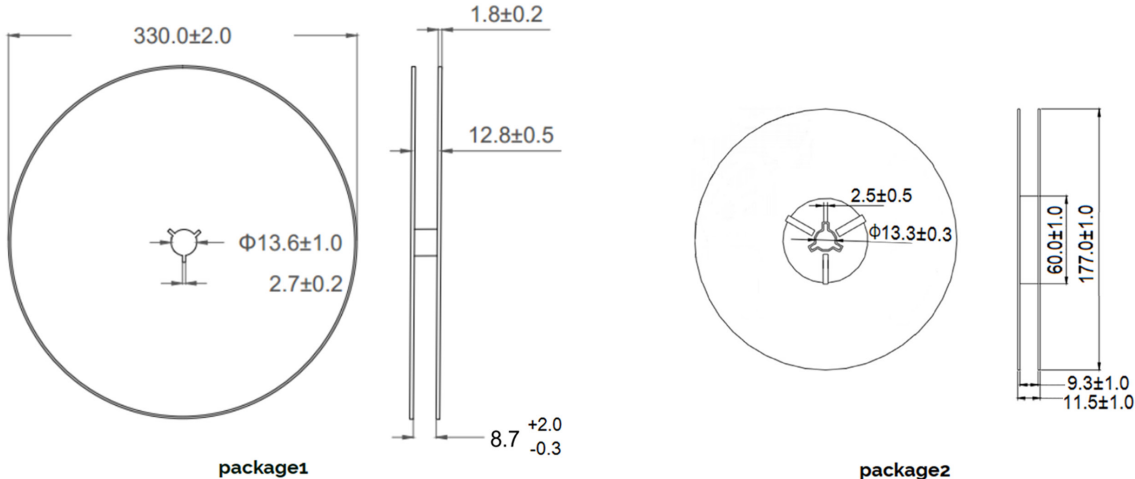

Note for Figure 12:
 1. Drawings are not to scale. Drawing dimensions are in millimeters.

Figure 13: Emitter Tape Drawings

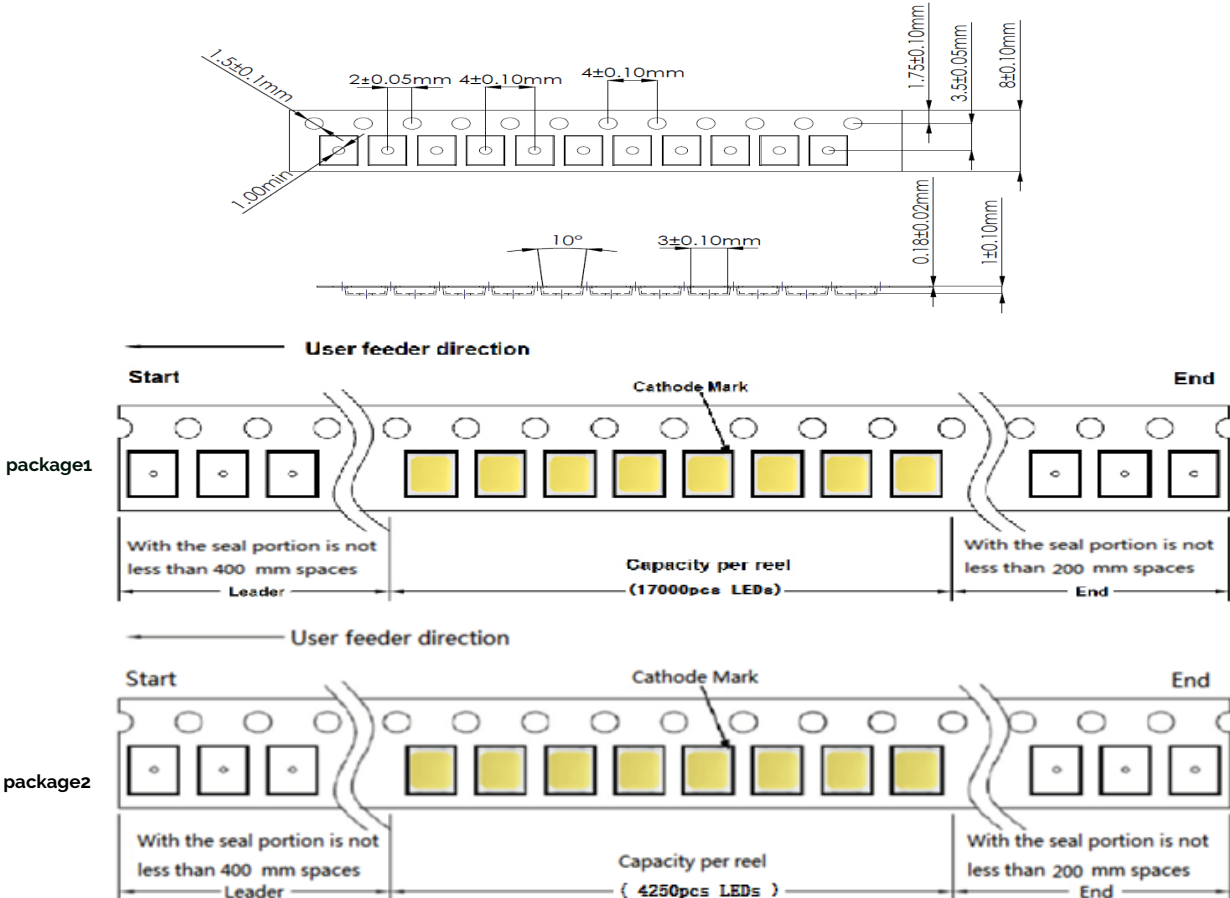

Note for Figure 13:
 1. Drawings are not to scale. Drawing dimensions are in millimeters.

Packaging

Figure 14: Emitter Reel Packaging Drawings

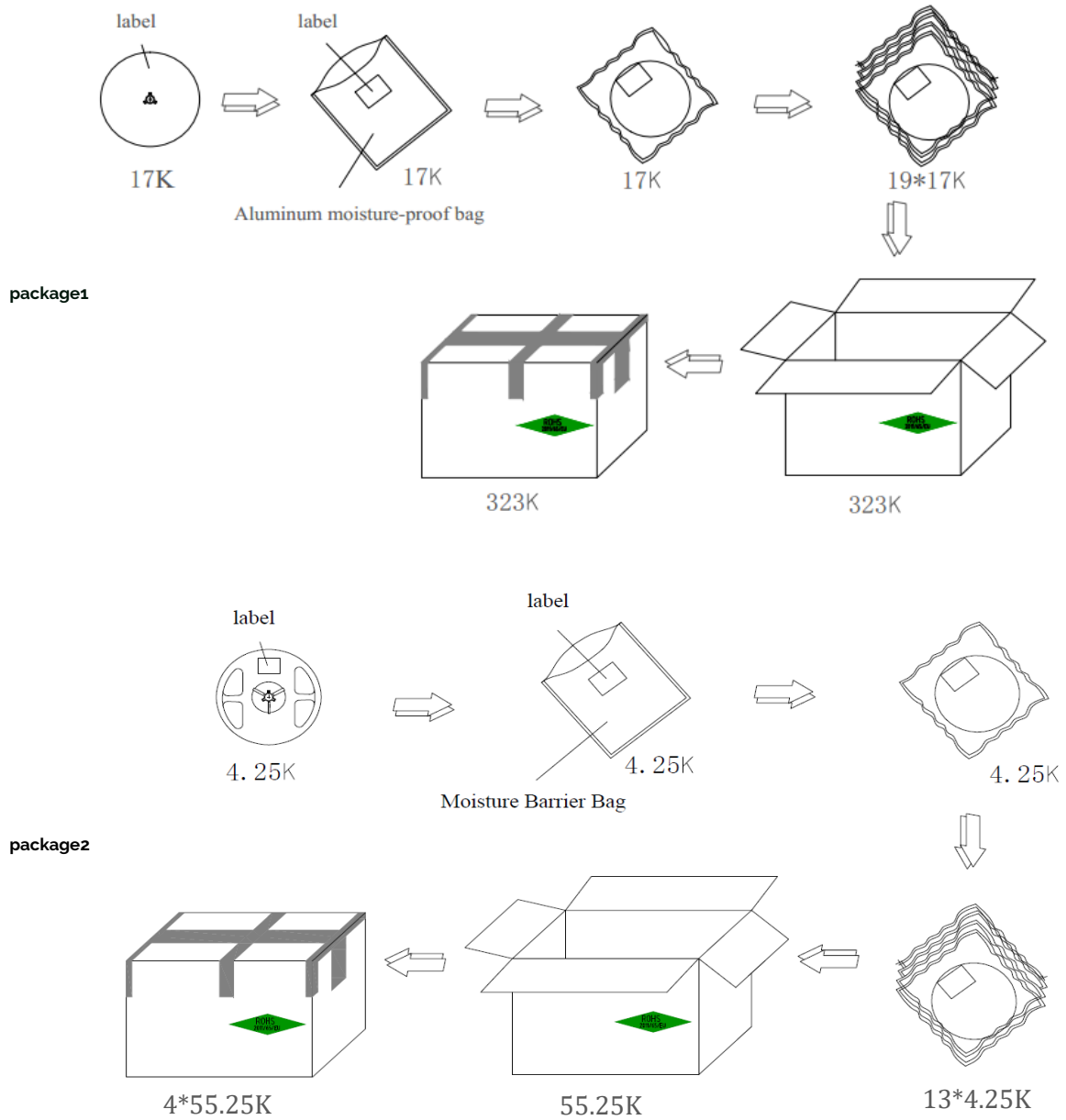

Note for Figure 14:
1. Drawings are not to scale.

Design Resources

Please contact your Bridgelux sales representative for assistance.

Precautions

CAUTION: CHEMICAL EXPOSURE HAZARD

Exposure to some chemicals commonly used in luminaire manufacturing and assembly can cause damage to the LED emitter. Please consult Bridgelux Application Note AN51 for additional information.

CAUTION: EYE SAFETY

Eye safety classification for the use of Bridgelux SMD LED emitter is in accordance with IEC specification EN62471: Photobiological Safety of Lamps and Lamp Systems. SMD LED emitters are classified as Risk Group 1 when operated at or below the maximum drive current. Please use appropriate precautions. It is important that employees working with LEDs are trained to use them safely.

CAUTION: RISK OF BURN

Do not touch the SMD LED emitter during operation. Allow the emitter to cool for a sufficient period of time before handling. The SMD LED emitter may reach elevated temperatures such that could burn skin when touched.

CAUTION

CONTACT WITH LIGHT EMITTING SURFACE (LES)

Avoid any contact with the LES. Do not touch the LES of the emitter or apply stress to the LES (yellow phosphor resin area). Contact may cause damage to the emitter

Optics and reflectors must not be mounted in contact with the LES (yellow phosphor resin area).

Disclaimers

MINOR PRODUCT CHANGE POLICY

The rigorous qualification testing on products offered by Bridgelux provides performance assurance. Slight cosmetic changes that do not affect form, fit, or function may occur as Bridgelux continues product optimization.

STANDARD TEST CONDITIONS

Unless otherwise stated, LED emitter testing is performed at the nominal drive current.

About Bridgelux: Bridging Light and Life™

At Bridgelux, we help companies, industries and people experience the power and possibility of light. Since 2002, we've designed LED solutions that are high performing, energy efficient, cost effective and easy to integrate. Our focus is on light's impact on human behavior, delivering products that create better environments, experiences and returns—both experiential and financial. And our patented technology drives new platforms for commercial and industrial luminaires.

For more information about the company, please visit
bridgelux.com
twitter.com/Bridgelux
facebook.com/Bridgelux
youtube.com/user/Bridgelux
WeChat ID: BridgeluxInChina
https://www.linkedin.com/company/bridgelux-inc-_2



46410 Fremont Boulevard
Fremont, CA 94538 USA
Tel (925) 583-8400
Fax (925) 583-8401
www.bridgelux.com

© 2026 Bridgelux, Inc. All rights reserved 2026. Product specifications are subject to change without notice. Bridgelux and the Bridgelux stylized logo design are registered trademarks of Bridgelux, Inc. All other trademarks are the property of their respective owners.