



Bridgelux® Gen 8 V6 HD LED Array

Product Data Sheet DS407



Introduction

V Series HD



V Series™ HD LED array product, an ultra-high lumen density COB product line, is designed for high intensity spotlights used in commercial and retail settings. V Series HD arrays offer industry leading color over angle uniformity, and replace ceramic metal halide lamps by providing equal or greater center beam candle power at lower power and at greater lifetimes. Their tight beam control and exceptional quality of light is well suited for demanding directional spot applications.

The V6 HD LED array is available in a variety of CCT and CRI combinations providing substantial design flexibility and energy efficiencies.

Lighting system designs incorporating these LED arrays deliver increased system level efficacy and longer service life. Typical applications include, but are not limited to, commercial and residential down lights, accent, spot and track lights.

Bridgelux Décor Series™ is our state of the art color line designed specifically for premium applications, producing unmatched LED light quality with brilliant color-rendering options and offer pleasing and inspiring lighting palettes. Bridgelux Décor Series color points are available on Vero® SE Series, Vero® Series, V Series™ and V Series™ HD.

Décor Series™ Ultra products provide a high CRI of 97 and a minimum Rg value of 91, which emphasizes the reds and color tones to which the human eye is most receptive - perfect for the most luxurious retail shops and world renowned museums. Décor Series Ultra is designed as a replacement for halogen.

Features

- Efficacy of 140 lm/W typical
- Compact high flux density light source
- Uniform high quality illumination
- Minimum 80, 90 and 95 CRI options
- Streamlined thermal path
- ENERGY STAR® / ANSI compliant color binning structure with 3 SDCM options
- More energy efficient than incandescent, halogen and fluorescent lamps
- Low voltage DC operation
- Instant light with unlimited dimming

Benefits

- Enhanced optical control
- Clean white light without pixelation
- High quality true color reproduction
- Significantly reduced thermal resistance and increased operating temperatures
- Uniform consistent white light
- Lower operating costs
- Easy to use with daylight and motion detectors to enable increased energy savings
- Reduced maintenance costs
- Environmentally friendly, no disposal issue

Contents

Product Feature Map	2
Product Nomenclature	2
Product Selection Guide	3
European Product Registry for Energy Labeling	7
Performance at Commonly Used Drive Currents	9
Electrical Characteristics	16
Eye Safety	17
Absolute Maximum Ratings	18
Performance Curves	19
Typical Radiation Pattern	21
Typical Color Spectrum	22
Mechanical Dimensions	23
Color Binning Information	24
Packaging and Labeling	25
Design Resources	27
Precautions	27
Disclaimers	27
About Bridgelux	28

Product Feature Map

Bridgelux arrays are fully engineered devices that provide consistent thermal and optical performance on an engineered mechanical platform. The V Series HD arrays are the most compact chip-on-board devices across all of Bridgelux's LED Array products.

The arrays incorporate several features to simplify design integration and assembly. Please visit www.bridgelux.com for more information on the V Series HD family of products.

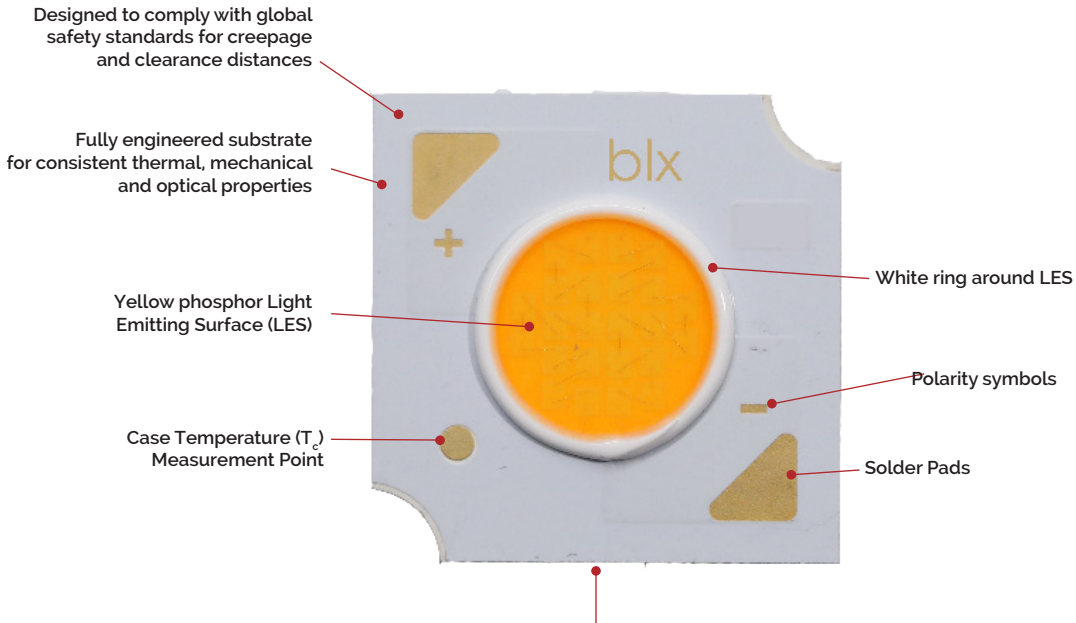

Note: Part number and lot codes are scribed on back of array

Product Nomenclature

The part number designation for Bridgelux V Series HD LED arrays is explained as follows:

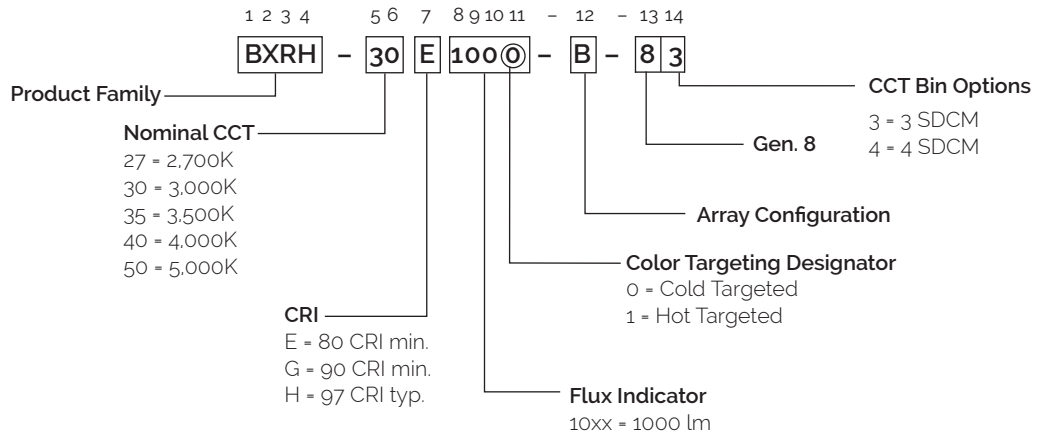

Product Selection Guide

The following product configurations are available:

Table 1: Selection Guide, Pulsed Measurement Data ($T_j = T_c = 25^\circ\text{C}$)

Part Number	Nominal CCT ¹ (K)	CRI ²	Nominal Drive Current ³ (mA)	Typical Pulsed Flux ^{4,5,6} $T_c = 25^\circ\text{C}$ (lm)	Minimum Pulsed Flux ^{6,7} $T_c = 25^\circ\text{C}$ (lm)	Typical V_f (V)	Typical Power (W)	Typical Efficacy (lm/W)
BXRH-22G1000-B-8x	2200	90	350	1160	1044	36.6	12.8	91
BXRH-22G1000-G-8x	2200	90	700	1160	1044	18.3	12.8	91
BXRH-22H1000-B-8x	2200	97	350	980	882	36.6	12.8	77
BXRH-22H1000-G-8x	2200	97	700	980	882	18.3	12.8	77
BXRH-24G1000-B-8x	2400	90	350	1240	1116	36.6	12.8	97
BXRH-24G1000-G-8x	2400	90	700	1240	1116	18.3	12.8	97
BXRH-24H1000-B-8x	2400	97	350	1050	945	36.6	12.8	82
BXRH-24H1000-G-8x	2400	97	700	1050	945	18.3	12.8	82
BXRH-27E1000-B-8x	2700	80	350	1691	1522	36.6	12.8	132
BXRH-27E1000-G-8x	2700	80	700	1691	1522	18.3	12.8	132
BXRH-27G1000-B-8x	2700	90	350	1395	1256	36.6	12.8	109
BXRH-27G1000-G-8x	2700	90	700	1395	1256	18.3	12.8	109
BXRH-27G10H0-B-8x	2700	90	350	1448	1303	36.6	12.8	113
BXRH-27G10H0-G-8x	2700	90	700	1448	1303	18.3	12.8	113
BXRH-27H1000-B-8x	2700	97	350	1237	1113	36.6	12.8	97
BXRH-27H1000-G-8x	2700	97	700	1237	1113	18.3	12.8	97
BXRH-30E1000-B-8x	3000	80	350	1797	1617	36.6	12.8	140
BXRH-30E1000-G-8x	3000	80	700	1797	1617	18.3	12.8	140
BXRH-30G1000-B-8x	3000	90	350	1459	1313	36.6	12.8	114
BXRH-30G1000-G-8x	3000	90	700	1459	1313	18.3	12.8	114
BXRH-30G10H0-B-8x	3000	90	350	1522	1370	36.6	12.8	119
BXRH-30G10H0-G-8x	3000	90	700	1522	1370	18.3	12.8	119
BXRH-30H1000-B-8x	3000	97	350	1321	1189	36.6	12.8	103
BXRH-30H1000-G-8x	3000	97	700	1321	1189	18.3	12.8	103
BXRH-35E1000-B-8x	3500	80	350	1839	1655	36.6	12.8	144
BXRH-35E1000-G-8x	3500	80	700	1839	1655	18.3	12.8	144
BXRH-35G1000-B-8x	3500	90	350	1512	1360	36.6	12.8	118
BXRH-35G1000-G-8x	3500	90	700	1512	1360	18.3	12.8	118
BXRH-35H1000-B-8x	3500	97	350	1358	1222	36.6	12.8	106
BXRH-35H1000-G-8x	3500	97	700	1358	1222	18.3	12.8	106
BXRH-40E1000-B-8x	4000	80	350	1850	1665	36.6	12.8	144
BXRH-40E1000-G-8x	4000	80	700	1850	1665	18.3	12.8	144

Notes for Table 1:

- Nominal CCT as defined by ANSI C78.377-2011.
- CRI values are typical for Decor Series Ultra. CRI values are minimums for all other products. Minimum Rg value for 80 CRI products is 0, the minimum Rg values for 90 CRI products is 50, the minimum Rg values for 97 CRI products is 91. Bridgelux maintains a ± 3 tolerance on CRI and Rg values.
- Drive current is referred to as nominal drive current.
- Products tested under pulsed condition (10ms pulse width) at nominal drive current where T_j (junction temperature) - T_c (case temperature) = 25°C .
- Typical performance values are provided as a reference only and are not a guarantee of performance.
- Bridgelux maintains a $\pm 7\%$ tolerance on flux measurements.
- Minimum flux values at the nominal test current are guaranteed by 100% test.

Product Selection Guide

Table 1: Selection Guide, Pulsed Measurement Data ($T_j = T_c = 25^\circ\text{C}$)(Continued)

Part Number	Nominal CCT ¹ (K)	CRI ²	Nominal Drive Current ³ (mA)	Typical Pulsed Flux ^{4,5,6} $T_c = 25^\circ\text{C}$ (lm)	Minimum Pulsed Flux ^{6,7} $T_c = 25^\circ\text{C}$ (lm)	Typical V_f (V)	Typical Power (W)	Typical Efficacy (lm/W)
BXRH-40G1000-B-8x	4000	90	350	1543	1389	36.6	12.8	120
BXRH-40G1000-G-8x	4000	90	700	1543	1389	18.3	12.8	120
BXRH-40H1000-B-8x	4000	97	350	1395	1256	36.6	12.8	109
BXRH-40H1000-G-8x	4000	97	700	1395	1256	18.3	12.8	109
BXRH-50E1001-B-8x	5000	80	350	1869	1682	36.6	12.4	146
BXRH-50E1001-G-8x	5000	80	700	1869	1682	18.3	12.4	146
BXRH-50G1001-B-8x	5000	90	350	1543	1389	36.6	12.8	120
BXRH-50G1001-G-8x	5000	90	700	1543	1389	18.3	12.8	120
BXRH-57E1001-B-8x	5700	80	350	1797	1617	36.6	12.8	140
BXRH-57E1001-G-8x	5700	80	700	1797	1617	18.3	12.8	140

Notes for Table 1:

- Nominal CCT as defined by ANSI C78.377-2011.
- CRI values are typical for Decor Series Ultra. CRI values are minimums for all other products. Minimum Rg value for 80 CRI products is 0, the minimum Rg values for 90 CRI products is 50, the minimum Rg values for 97 CRI products is 91. Bridgelux maintains a ± 3 tolerance on CRI and Rg values.
- Drive current is referred to as nominal drive current.
- Products tested under pulsed condition (10ms pulse width) at nominal drive current where T_j (junction temperature) - T_c (case temperature) = 25°C .
- Typical performance values are provided as a reference only and are not a guarantee of performance.
- Bridgelux maintains a $\pm 7\%$ tolerance on flux measurements.
- Minimum flux values at the nominal test current are guaranteed by 100% test.

Product Selection Guide

Table 2: Selection Guide, Stabilized DC Performance ($T_c = 85^\circ\text{C}$)

Part Number	Nominal CCT ¹ (K)	CRI ²	Nominal Drive Current ³ (mA)	Typical DC Flux ^{4,5} $T_c = 85^\circ\text{C}$ (lm)	Minimum DC Flux ⁶ $T_c = 85^\circ\text{C}$ (lm)	Typical V_f (V)	Typical Power (W)	Typical Efficacy (lm/W)
BXRH-22G1000-B-8x	2200	90	350	1044	940	35.4	12.4	84
BXRH-22G1000-G-8x	2200	90	700	1044	940	17.7	12.4	84
BXRH-22H1000-B-8x	2200	97	350	882	794	35.4	12.4	71
BXRH-22H1000-G-8x	2200	97	700	882	794	17.7	12.4	71
BXRH-24G1000-B-8x	2400	90	350	1116	1004	35.4	12.4	90
BXRH-24G1000-G-8x	2400	90	700	1116	1004	17.7	12.4	90
BXRH-24H1000-B-8x	2400	97	350	945	851	35.4	12.4	76
BXRH-24H1000-G-8x	2400	97	700	945	851	17.7	12.4	76
BXRH-27E1000-B-8x	2700	80	350	1522	1370	35.4	12.4	123
BXRH-27E1000-G-8x	2700	80	700	1522	1370	17.7	12.4	123
BXRH-27G1000-B-8x	2700	90	350	1256	1130	35.4	12.4	101
BXRH-27G1000-G-8x	2700	90	700	1256	1130	17.7	12.4	101
BXRH-27G10Ho-B-8x	2700	90	350	1303	1173	35.4	12.4	105
BXRH-27G10Ho-G-8x	2700	90	700	1303	1173	17.7	12.4	105
BXRH-27H1000-B-8x	2700	97	350	1113	1002	35.4	12.4	90
BXRH-27H1000-G-8x	2700	97	700	1113	1002	17.7	12.4	90
BXRH-30E1000-B-8x	3000	80	350	1617	1456	35.4	12.4	131
BXRH-30E1000-G-8x	3000	80	700	1617	1456	17.7	12.4	131
BXRH-30G1000-B-8x	3000	90	350	1313	1182	35.4	12.4	106
BXRH-30G1000-G-8x	3000	90	700	1313	1182	17.7	12.4	106
BXRH-30G10Ho-B-8x	3000	90	350	1370	1233	35.4	12.4	111
BXRH-30G10Ho-G-8x	3000	90	700	1370	1233	17.7	12.4	111
BXRH-30H1000-B-8x	3000	97	350	1189	1070	35.4	12.4	96
BXRH-30H1000-G-8x	3000	97	700	1189	1070	17.7	12.4	96
BXRH-35E1000-B-8x	3500	80	350	1655	1490	35.4	12.4	134
BXRH-35E1000-G-8x	3500	80	700	1655	1490	17.7	12.4	134
BXRH-35G1000-B-8x	3500	90	350	1360	1224	35.4	12.4	110
BXRH-35G1000-G-8x	3500	90	700	1360	1224	17.7	12.4	110
BXRH-35H1000-B-8x	3500	97	350	1222	1100	35.4	12.4	99
BXRH-35H1000-G-8x	3500	97	700	1222	1100	17.7	12.4	99
BXRH-40E1000-B-8x	4000	80	350	1665	1498	35.4	12.4	134
BXRH-40E1000-G-8x	4000	80	700	1665	1498	17.7	12.4	134

Notes for Table 2:

- Nominal CCT as defined by ANSI C78.377-2011.
- All CRI values are measured at $T_j = T_c = 25^\circ\text{C}$. CRI values are typical for Decor Series Ultra . CRI values are minimums for all other products. Minimum R_g value for 80 CRI products is 0, the minimum R_g values for 90 CRI products is 50, the minimum R_g values for 97 CRI products is 91. Bridgelux maintains a ± 3 tolerance on CRI and R_g values.
- Drive current is referred to as nominal drive current.
- Typical stabilized DC performance values are provided as reference only and are not a guarantee of performance.
- Typical performance is estimated based on operation under DC (direct current) with LED array mounted onto a heat sink with thermal interface material and the case temperature maintained at 85°C . Based on Bridgelux test setup, values may vary depending on the thermal design of the luminaire and/or the exposed environment to which the product is subjected.
- Minimum flux values at elevated temperatures are provided for reference only and are not guaranteed by 100% production testing. Based on Bridgelux test setup, values may vary depending on the thermal design of the luminaire and/or the exposed environment to which the product is subjected.

Product Selection Guide

Table 2: Selection Guide, Stabilized DC Performance ($T_c = 85^\circ\text{C}$) (Continued)

Part Number	Nominal CCT ¹ (K)	CRI ²	Nominal Drive Current ³ (mA)	Typical DC Flux ^{4,5} $T_c = 85^\circ\text{C}$ (lm)	Minimum DC Flux ⁶ $T_c = 85^\circ\text{C}$ (lm)	Typical V_f (V)	Typical Power (W)	Typical Efficacy (lm/W)
BXRH-40G1000-B-8x	4000	90	350	1389	1250	35.4	12.4	112
BXRH-40G1000-G-8x	4000	90	700	1389	1250	17.7	12.4	112
BXRH-40H1000-B-8x	4000	97	350	1256	1130	35.4	12.4	101
BXRH-40H1000-G-8x	4000	97	700	1256	1130	17.7	12.4	101
BXRH-50E1001-B-8x	5000	80	350	1682	1513	35.4	12.4	136
BXRH-50E1001-G-8x	5000	80	700	1682	1513	17.7	12.4	136
BXRH-50G1001-B-8x	5000	90	350	1389	1250	35.4	12.4	112
BXRH-50G1001-G-8x	5000	90	700	1389	1250	17.7	12.4	112
BXRH-57E1001-B-8x	5700	80	350	1617	1456	35.4	12.4	131
BXRH-57E1001-G-8x	5700	80	700	1617	1456	17.7	12.4	131

Notes for Table 2:

- Nominal CCT as defined by ANSI C78.377-2011.
- All CRI values are measured at $T_j = T_c = 25^\circ\text{C}$. CRI values are typical for Decor Series Ultra. CRI values are minimums for all other products. Minimum Rg value for 80 CRI products is 0, the minimum Rg values for 90 CRI products is 50, the minimum Rg values for 97 CRI products is 91. Bridgelux maintains a ± 3 tolerance on CRI and Rg values.
- Drive current is referred to as nominal drive current.
- Typical stabilized DC performance values are provided as reference only and are not a guarantee of performance.
- Typical performance is estimated based on operation under DC (direct current) with LED array mounted onto a heat sink with thermal interface material and the case temperature maintained at 85°C . Based on Bridgelux test setup, values may vary depending on the thermal design of the luminaire and/or the exposed environment to which the product is subjected.
- Minimum flux values at elevated temperatures are provided for reference only and are not guaranteed by 100% production testing. Based on Bridgelux test setup, values may vary depending on the thermal design of the luminaire and/or the exposed environment to which the product is subjected.

European Product Registry for Energy Labeling

The European Product Registry for Energy Labeling (EPREL) is defined in the EU Regulation 2017/1369 to provide important energy efficiency information to consumers. Together with Energy Labeling Regulation ELR (EU) 2019/2015 which was amended by regulation (EU) 2021/340 for energy labelling of light sources, manufacturers are required to declare an energy class based on key technical specifications from each of their product and register it in an open data base managed by EPREL. It is now a legal requirement for a vendor of light sources to upload information about their products into the EPREL database before placing these products on the market in the EU.

Table 3 below provides a list of part numbers that are in compliance with ELR and are currently listed in the EPREL database.

At Bridgelux, we are fully committed to supplying products that are compliant with pertinent laws, rules, and obligation imposed by relevant government bodies including the European Energy Labeling regulation. Customers can use these products with full confidence for any projects that fall under the ELR.

Table 3: Part numbers registered in European Product Registry for Energy Labeling

PART NUMBER ¹	CCT (K)	CRI	Current ² (mA)	Vf (V)	Useful flux ³ (Φ_{use}) at 85°C (lm)	Power (W)	Efficacy (lm/W)	Energy efficiency class ⁴ 	Registration No	URL to Product Information Sheet in EPREL Database
BXRH-27E1000-B-8x	2700	80	500	36.7	2060	18.3	112	F	875783	https://eprelec.europa.eu/qr/875783
BXRH-27E1000-G-8x	2700	80	1030	18.9	2153	19.4	111	F	875787	https://eprelec.europa.eu/qr/875787
BXRH-27G1000-B-8x	2700	90	360	35.0	1274	12.6	101	F	875805	https://eprelec.europa.eu/qr/875805
BXRH-27G1000-G-8x	2700	90	740	17.0	1274	12.6	101	F	875809	https://eprelec.europa.eu/qr/875809
BXRH-27G10H0-B-8x	2700	90	400	37.2	1508	14.9	101	F	875817	https://eprelec.europa.eu/qr/875817
BXRH-27G10H0-G-8x	2700	90	820	18.1	1508	14.9	101	F	875821	https://eprelec.europa.eu/qr/875821
BXRH-27H1000-B-8x	2700	95	280	36.8	960	10.3	93	F	875839	https://eprelec.europa.eu/qr/875839
BXRH-27H1000-G-8x	2700	95	590	17.4	960	10.3	93	F	875843	https://eprelec.europa.eu/qr/875843
BXRH-30E1000-B-8x	3000	80	580	37.5	2472	21.8	114	F	875869	https://eprelec.europa.eu/qr/875869
BXRH-30E1000-G-8x	3000	80	1180	18.4	2472	21.7	114	F	875873	https://eprelec.europa.eu/qr/875873
BXRH-30G1000-B-8x	3000	90	410	36.3	1519	14.9	102	F	875901	https://eprelec.europa.eu/qr/875901
BXRH-30G1000-G-8x	3000	90	830	17.9	1519	14.9	102	F	875905	https://eprelec.europa.eu/qr/875905
BXRH-30G10H0-B-8x	3000	90	450	38.2	1768	17.2	103	F	875921	https://eprelec.europa.eu/qr/875921
BXRH-30G10H0-G-8x	3000	90	930	18.4	1768	17.1	103	F	875925	https://eprelec.europa.eu/qr/875925
BXRH-30H1000-B-8x	3000	95	340	33.7	1118	11.5	98	F	875948	https://eprelec.europa.eu/qr/875948
BXRH-30H1000-G-8x	3000	95	700	18.0	1207	12.6	96	F	875952	https://eprelec.europa.eu/qr/875952
BXRH-35E1000-B-8x	3500	80	600	38.2	2621	22.9	114	F	875986	https://eprelec.europa.eu/qr/875986
BXRH-35E1000-G-8x	3500	80	1200	19.1	2621	22.9	115	F	875990	https://eprelec.europa.eu/qr/875990
BXRH-35G1000-B-8x	3500	90	440	36.5	1666	16.0	104	F	876006	https://eprelec.europa.eu/qr/876006
BXRH-35G1000-G-8x	3500	90	910	17.6	1666	16.0	104	F	876010	https://eprelec.europa.eu/qr/876010
BXRH-35H1000-B-8x	3500	95	360	35.0	1240	12.6	98	F	876028	https://eprelec.europa.eu/qr/876028

Notes for Table 3:

1. All device listed here must be disposed as e-waste upon its end of life according to local country guideline in each country.
2. For information on performance values at alternative drive conditions, please refer to the Product Selection Guide, Absolute Maximum Rating Table and Performance Curves in this data sheet.
3. For a definition of useful luminous flux (Φ_{use}), please see the ELR regulations at <https://tinyurl.com/4b6zvt4m>.
4. EPREL requires an arrow symbol containing the letter of the energy efficiency class to be displayed, on technical promotional material. Refer to this energy efficiency class column for specific energy efficiency class on each part number.

European Product Registry for Energy Labeling

Table 3: Part numbers registered in European Product Registry for Energy Labeling (Continued)

PART NUMBER ¹	CCT (K)	CRI	Current ² (mA)	Vf (V)	Useful flux ³ (Φ_{use}) at 85C (lm)	Power (W)	Efficacy (lm/W)	Energy efficiency class ⁴ 	Registration No	URL to Product Information Sheet in EPREL Database
BXRH-40E1000-B-8x	4000	80	600	38.2	2636	22.9	115	F	876048	https://eprelec.europa.eu/qr/876048
BXRH-40E1000-G-8x	4000	80	1200	19.1	2636	22.9	115	F	876052	https://eprelec.europa.eu/qr/876052
BXRH-40G1000-B-8x	4000	90	470	36.6	1792	17.2	104	F	876070	https://eprelec.europa.eu/qr/876070
BXRH-40G1000-G-8x	4000	90	960	17.9	1792	17.1	105	F	876074	https://eprelec.europa.eu/qr/876074
BXRH-40H1000-B-8x	4000	95	390	35.3	1365	13.8	99	F	876092	https://eprelec.europa.eu/qr/876092
BXRH-40H1000-G-8x	4000	95	800	17.1	1365	13.7	100	F	876096	https://eprelec.europa.eu/qr/876096
BXRH-50E1001-B-83	5000	80	600	38.2	2666	22.9	116	F	876123	https://eprelec.europa.eu/qr/876123
BXRH-50E1001-G-83	5000	80	1200	19.1	2666	22.9	117	F	876125	https://eprelec.europa.eu/qr/876125
BXRH-50G1001-B-83	5000	90	530	36.8	2058	19.5	106	F	876139	https://eprelec.europa.eu/qr/876139
BXRH-50G1001-G-83	5000	90	1070	18.2	2058	19.4	106	F	876141	https://eprelec.europa.eu/qr/876141

Notes for Table 3:

1. All device listed here must be disposed as e-waste upon its end of life according to local country guideline in each country.
2. For information on performance values at alternative drive conditions, please refer to the Product Selection Guide, Absolute Maximum Rating Table and Performance Curves in this data sheet.
3. For a definition of useful luminous flux (Φ_{use}), please see the ELR regulations at <https://tinyurl.com/4b6zvt4m>.
4. EPREL requires an arrow symbol containing the letter of the energy efficiency class to be displayed, on technical promotional material. Refer to this energy efficiency class column for specific energy efficiency class on each part number.

Performance at Commonly Used Drive Currents

V Series HD LED arrays are tested to the specifications shown using the nominal drive currents in Table 1. V Series HD LED arrays may also be driven at other drive currents dependent on specific application design requirements. The performance at any drive current can be derived from the current vs. voltage characteristics shown in Figures 1 & 2 and the flux vs. current characteristics shown in Figures 3 & 4. The performance at commonly used drive currents is summarized in Table 4.

Table 4: Product Performance at Commonly Used Drive Currents

Part Number	CRI	Drive Current ¹ (mA)	Typical V_f $T_c = 25^\circ\text{C}$ (V)	Typical Power $T_c = 25^\circ\text{C}$ (W)	Typical Flux ² $T_c = 25^\circ\text{C}$ (lm)	Typical DC Flux ³ $T_c = 85^\circ\text{C}$ (lm)	Typical Efficacy $T_c = 25^\circ\text{C}$ (lm/W)
BXRH-22G1000-B-8x	90	175	34.2	6.0	619	557	103
		250	35.3	8.8	862	776	98
		350	36.6	12.8	1160	1044	91
		440	37.8	16.6	1423	1281	86
		480	38.2	18.3	1532	1379	84
BXRH-22G1000-G-8x	90	600	39.5	23.7	1837	1653	78
		350	17.1	6.0	619	557	103
		500	17.7	8.9	862	776	97
		700	18.3	12.8	1160	1044	91
		880	18.9	16.6	1423	1281	86
BXRH-22H1000-B-8x	97	960	19.1	18.3	1532	1379	84
		1200	19.7	23.6	1837	1653	78
		175	34.2	6.0	523	471	87
		250	35.3	8.8	728	656	83
		350	36.6	12.8	980	882	77
BXRH-22H1000-G-8x	97	440	37.8	16.6	1203	1082	72
		480	38.2	18.3	1294	1165	71
		600	39.5	23.7	1552	1397	65
		350	17.1	6.0	523	471	87
		500	17.7	8.9	728	656	82
BXRH-24G1000-B-8x	90	700	18.3	12.8	980	882	77
		880	18.9	16.6	1203	1082	72
		960	19.1	18.3	1294	1165	71
		1200	19.7	23.6	1552	1397	66
		175	34.2	6.0	662	596	111
BXRH-24G1000-G-8x	90	250	35.3	8.8	922	830	104
		350	36.6	12.8	1240	1116	97
		440	37.8	16.6	1522	1369	91
		480	38.2	18.3	1637	1474	89
		600	39.5	23.7	1964	1767	83
BXRH-24G1000-G-8x	90	350	17.1	6.0	662	596	111
		500	17.7	8.9	922	830	104
		700	18.3	12.8	1240	1116	97
		880	18.9	16.6	1522	1369	91
		960	19.1	18.3	1637	1474	89
1200	19.7	23.6	1964	1767	83		

Notes for Table 4:

1. Alternate drive currents are provided for reference only and are not a guarantee of performance.
2. Bridgelux maintains a $\pm 7\%$ tolerance on flux measurements.
3. Typical stabilized DC performance values are provided as reference only and are not a guarantee of performance.

Performance at Commonly Used Drive Currents

Table 4: Product Performance at Commonly Used Drive Currents (continued)

Part Number	CRI	Drive Current ¹ (mA)	Typical V _f T _c = 25°C (V)	Typical Power T _c = 25°C (W)	Typical Flux ² T _c = 25°C (lm)	Typical DC Flux ³ T _c = 85°C (lm)	Typical Efficacy T _c = 25°C (lm/W)
BXRH-24H1000-B-8x	97	175	34.2	6.0	561	505	94
		250	35.3	8.8	781	702	88
		350	36.6	12.8	1050	945	82
		440	37.8	16.6	1288	1160	77
		480	38.2	18.3	1387	1248	76
		600	39.5	23.7	1663	1497	70
BXRH-24H1000-G-8x	97	350	17.1	6.0	561	505	94
		500	17.7	8.9	781	702	88
		700	18.3	12.8	1050	945	82
		880	18.9	16.6	1288	1160	77
		960	19.1	18.3	1387	1248	76
		1200	19.7	23.6	1663	1497	70
BXRH-27E1000-B-8x	80	175	34.2	6.0	903	813	151
		250	35.3	8.8	1257	1131	142
		350	36.6	12.8	1691	1522	132
		440	37.8	16.6	2075	1867	125
		480	38.2	18.4	2233	2010	122
		600	39.5	23.7	2678	2410	113
BXRH-27E1000-G-8x	80	350	17.1	6.0	903	813	151
		500	17.7	8.8	1257	1131	142
		700	18.3	12.8	1691	1522	132
		880	18.9	16.6	2075	1867	125
		960	19.1	18.4	2233	2010	122
		1200	19.7	23.7	2678	2410	113
BXRH-27G1000-B-8x	90	175	34.2	6.0	745	671	124
		250	35.3	8.8	1037	933	117
		350	36.6	12.8	1395	1256	109
		440	37.8	16.6	1712	1541	103
		480	38.2	18.4	1842	1658	100
		600	39.5	23.7	2209	1988	93
BXRH-27G1000-G-8x	90	350	17.1	6.0	745	671	124
		500	17.7	8.8	1037	933	117
		700	18.3	12.8	1395	1256	109
		880	18.9	16.6	1712	1541	103
		960	19.1	18.4	1842	1658	100
		1200	19.7	23.7	2209	1988	93
BXRH-27G10H0-B-8x	90	175	34.2	6.0	774	696	129
		250	35.3	8.8	1076	968	122
		350	36.6	12.8	1448	1303	113
		440	37.8	16.6	1777	1599	107
		480	38.2	18.4	1912	1721	104
		600	39.5	23.7	2293	2064	97

Notes for Table 4:

1. Alternate drive currents are provided for reference only and are not a guarantee of performance.
2. Bridgelux maintains a ± 7% tolerance on flux measurements.
3. Typical stabilized DC performance values are provided as reference only and are not a guarantee of performance.

Performance at Commonly Used Drive Currents

Table 4: Product Performance at Commonly Used Drive Currents (continued)

Part Number	CRI	Drive Current ¹ (mA)	Typical V _f T _c = 25°C (V)	Typical Power T _c = 25°C (W)	Typical Flux ² T _c = 25°C (lm)	Typical DC Flux ³ T _c = 85°C (lm)	Typical Efficacy T _c = 25°C (lm/W)
BXRH-27G10H0-G-8x	90	350	17.1	6.0	774	696	129
		500	17.7	8.8	1076	968	122
		700	18.3	12.8	1448	1303	113
		880	18.9	16.6	1777	1599	107
		960	19.1	18.4	1912	1721	104
		1200	19.7	23.7	2293	2064	97
BXRH-27H1000-B-8x	97	175	34.2	6.0	661	595	110
		250	35.3	8.8	919	827	104
		350	36.6	12.8	1237	1113	97
		440	37.8	16.6	1517	1365	91
		480	38.2	18.4	1633	1470	89
		600	39.5	23.7	1958	1762	83
BXRH-27H1000-G-8x	97	350	17.1	6.0	661	595	110
		500	17.7	8.8	919	827	104
		700	18.3	12.8	1237	1113	97
		880	18.9	16.6	1517	1365	91
		960	19.1	18.4	1633	1470	89
		1200	19.7	23.7	1958	1762	83
BXRH-30E1000-B-8x	80	175	34.2	6.0	960	864	160
		250	35.3	8.8	1335	1202	151
		350	36.6	12.8	1797	1617	140
		440	37.8	16.6	2204	1984	133
		480	38.2	18.4	2372	2135	129
		600	39.5	23.7	2845	2561	120
BXRH-30E1000-G-8x	80	350	17.1	6.0	960	864	160
		500	17.7	8.8	1335	1202	151
		700	18.3	12.8	1797	1617	140
		880	18.9	16.6	2204	1984	133
		960	19.1	18.4	2372	2135	129
		1200	19.7	23.7	2845	2561	120
BXRH-30G1000-B-8x	90	175	34.2	6.0	779	701	130
		250	35.3	8.8	1084	976	123
		350	36.6	12.8	1459	1313	114
		440	37.8	16.6	1790	1611	108
		480	38.2	18.4	1926	1733	105
		600	39.5	23.7	2310	2079	97
BXRH-30G1000-G-8x	90	350	17.1	6.0	779	701	130
		500	17.7	8.8	1084	976	123
		700	18.3	12.8	1459	1313	114
		880	18.9	16.6	1790	1611	108
		960	19.1	18.4	1926	1733	105
		1200	19.7	23.7	2310	2079	97

Notes for Table 4:

1. Alternate drive currents are provided for reference only and are not a guarantee of performance.
2. Bridgelux maintains a ± 7% tolerance on flux measurements.
3. Typical stabilized DC performance values are provided as reference only and are not a guarantee of performance.

Performance at Commonly Used Drive Currents

Table 4: Product Performance at Commonly Used Drive Currents (continued)

Part Number	CRI	Drive Current ¹ (mA)	Typical V _f T _c = 25°C (V)	Typical Power T _c = 25°C (W)	Typical Flux ² T _c = 25°C (lm)	Typical DC Flux ³ T _c = 85°C (lm)	Typical Efficacy T _c = 25°C (lm/W)
BXRH-30G10H0-B-8x	90	175	34.2	6.0	813	732	136
		250	35.3	8.8	1131	1018	128
		350	36.6	12.8	1522	1370	119
		440	37.8	16.6	1867	1681	112
		480	38.2	18.4	2010	1809	110
		600	39.5	23.7	2410	2169	102
BXRH-30G10H0-G-8x	90	350	17.1	6.0	813	732	136
		500	17.7	8.8	1131	1018	128
		700	18.3	12.8	1522	1370	119
		880	18.9	16.6	1867	1681	112
		960	19.1	18.4	2010	1809	110
		1200	19.7	23.7	2410	2169	102
BXRH-30H1000-B-8x	97	175	34.2	6.0	706	635	118
		250	35.3	8.8	982	884	111
		350	36.6	12.8	1321	1189	103
		440	37.8	16.6	1621	1459	98
		480	38.2	18.4	1744	1570	95
		600	39.5	23.7	2092	1883	88
BXRH-30H1000-G-8x	97	350	17.1	6.0	706	635	118
		500	17.7	8.8	982	884	111
		700	18.3	12.8	1321	1189	103
		880	18.9	16.6	1621	1459	98
		960	19.1	18.4	1744	1570	95
		1200	19.7	23.7	2092	1883	88
BXRH-35E1000-B-9x	80	175	34.2	6.0	982	884	164
		250	35.3	8.8	1367	1230	155
		350	36.6	12.8	1839	1655	144
		440	37.8	16.6	2256	2031	136
		480	38.2	18.4	2428	2185	132
		600	39.5	23.7	2912	2621	123
BXRH-35E1000-G-9x	80	350	17.1	6.0	982	884	164
		500	17.7	8.8	1367	1230	155
		700	18.3	12.8	1839	1655	144
		880	18.9	16.6	2256	2031	136
		960	19.1	18.4	2428	2185	132
		1200	19.7	23.7	2912	2621	123
BXRH-35G1000-B-8x	90	175	34.2	6.0	807	727	135
		250	35.3	8.8	1123	1011	127
		350	36.6	12.8	1512	1360	118
		440	37.8	16.6	1854	1669	112
		480	38.2	18.4	1996	1796	109
		600	39.5	23.7	2393	2154	101

Notes for Table 4:

1. Alternate drive currents are provided for reference only and are not a guarantee of performance.
2. Bridgelux maintains a ± 7% tolerance on flux measurements.
3. Typical stabilized DC performance values are provided as reference only and are not a guarantee of performance.

Performance at Commonly Used Drive Currents

Table 4: Product Performance at Commonly Used Drive Currents (continued)

Part Number	CRI	Drive Current ¹ (mA)	Typical V _f T _c = 25°C (V)	Typical Power T _c = 25°C (W)	Typical Flux ² T _c = 25°C (lm)	Typical DC Flux ³ T _c = 85°C (lm)	Typical Efficacy T _c = 25°C (lm/W)
BXRH-35G1000-G-8x	90	350	17.1	6.0	807	727	135
		500	17.7	8.8	1123	1011	127
		700	18.3	12.8	1512	1360	118
		880	18.9	16.6	1854	1669	112
		960	19.1	18.4	1996	1796	109
		1200	19.7	23.7	2393	2154	101
BXRH-35H1000-B-8x	97	175	34.2	6.0	726	653	121
		250	35.3	8.8	1009	908	114
		350	36.6	12.8	1358	1222	106
		440	37.8	16.6	1666	1500	100
		480	38.2	18.4	1793	1614	98
		600	39.5	23.7	2151	1936	91
BXRH-35H1000-G-8x	97	350	17.1	6.0	726	653	121
		500	17.7	8.8	1009	908	114
		700	18.3	12.8	1358	1222	106
		880	18.9	16.6	1666	1500	100
		960	19.1	18.4	1793	1614	98
		1200	19.7	23.7	2151	1936	91
BXRH-40E1000-B-8x	80	175	34.2	6.0	988	889	165
		250	35.3	8.8	1375	1237	156
		350	36.6	12.8	1850	1665	144
		440	37.8	16.6	2269	2042	137
		480	38.2	18.4	2442	2198	133
		600	39.5	23.7	2929	2636	124
BXRH-40E1000-G-8x	80	350	17.1	6.0	988	889	165
		500	17.7	8.8	1375	1237	156
		700	18.3	12.8	1850	1665	144
		880	18.9	16.6	2269	2042	137
		960	19.1	18.4	2442	2198	133
		1200	19.7	23.7	2929	2636	124
BXRH-40G1000-B-8x	90	175	34.2	6.0	824	742	138
		250	35.3	8.8	1147	1032	130
		350	36.6	12.8	1543	1389	120
		440	37.8	16.6	1893	1704	114
		480	38.2	18.4	2038	1834	111
		600	39.5	23.7	2444	2199	103
BXRH-40G1000-G-8x	90	350	17.1	6.0	824	742	138
		500	17.7	8.8	1147	1032	130
		700	18.3	12.8	1543	1389	120
		880	18.9	16.6	1893	1704	114
		960	19.1	18.4	2038	1834	111
		1200	19.7	23.7	2444	2199	103

Notes for Table 4:

1. Alternate drive currents are provided for reference only and are not a guarantee of performance.
2. Bridgelux maintains a ± 7% tolerance on flux measurements.
3. Typical stabilized DC performance values are provided as reference only and are not a guarantee of performance.

Performance at Commonly Used Drive Currents

Table 4: Product Performance at Commonly Used Drive Currents (continued)

Part Number	CRI	Drive Current ¹ (mA)	Typical V _f T _c = 25°C (V)	Typical Power T _c = 25°C (W)	Typical Flux ² T _c = 25°C (lm)	Typical DC Flux ³ T _c = 85°C (lm)	Typical Efficacy T _c = 25°C (lm/W)
BXRH-40H1000-B-8x	97	175	34.2	6.0	745	671	124
		250	35.3	8.8	1037	933	117
		350	36.6	12.8	1395	1256	109
		440	37.8	16.6	1712	1541	103
		480	38.2	18.4	1842	1658	100
		600	39.5	23.7	2209	1988	93
BXRH-40H1000-G-8x	97	350	17.1	6.0	745	671	124
		500	17.7	8.8	1037	933	117
		700	18.3	12.8	1395	1256	109
		880	18.9	16.6	1712	1541	103
		960	19.1	18.4	1842	1658	100
		1200	19.7	23.7	2209	1988	93
BXRH-50E1001-B-8x	80	175	34.2	6.0	998	898	166
		250	35.3	8.8	1389	1249	158
		350	36.6	12.8	1869	1682	146
		440	37.8	16.6	2292	2062	138
		480	38.2	18.4	2466	2220	134
		600	39.5	23.7	2958	2662	125
BXRH-50E1001-G-8x	80	350	17.1	6.0	998	898	166
		500	17.7	8.8	1389	1249	158
		700	18.3	12.8	1869	1682	146
		880	18.9	16.6	2292	2062	138
		960	19.1	18.4	2466	2220	134
		1200	19.7	23.7	2958	2662	125
BXRH-50G1001-B-8x	90	175	34.2	6.0	824	742	138
		250	35.3	8.8	1147	1032	130
		350	36.6	12.8	1543	1389	120
		440	37.8	16.6	1893	1704	114
		480	38.2	18.4	2038	1834	111
		600	39.5	23.7	2444	2199	103
BXRH-50G1001-G-8x	90	350	17.1	6.0	824	742	138
		500	17.7	8.8	1147	1032	130
		700	18.3	12.8	1543	1389	120
		880	18.9	16.6	1893	1704	114
		960	19.1	18.4	2038	1834	111
		1200	19.7	23.7	2444	2199	103
BXRH-57E1001-B-8x	80	175	34.2	6.0	960	864	160
		250	35.3	8.8	1335	1202	151
		350	36.6	12.8	1797	1617	140
		440	37.8	16.6	2204	1984	133
		480	38.2	18.4	2372	2135	129
		600	39.5	23.7	2845	2561	120

Notes for Table 4:

1. Alternate drive currents are provided for reference only and are not a guarantee of performance.
2. Bridgelux maintains a ± 7% tolerance on flux measurements.
3. Typical stabilized DC performance values are provided as reference only and are not a guarantee of performance.

Performance at Commonly Used Drive Currents

Table 4: Product Performance at Commonly Used Drive Currents (continued)

Part Number	CRI	Drive Current ¹ (mA)	Typical V _f T _c = 25°C (V)	Typical Power T _c = 25°C (W)	Typical Flux ² T _c = 25°C (lm)	Typical DC Flux ³ T _c = 85°C (lm)	Typical Efficacy T _c = 25°C (lm/W)
BXRH-57E1001-G-8x	80	350	17.1	6.0	960	864	160
		500	17.7	8.8	1335	1202	151
		700	18.3	12.8	1797	1617	140
		880	18.9	16.6	2204	1984	133
		960	19.1	18.4	2372	2135	129
		1200	19.7	23.7	2845	2561	120

Notes for Table 4:

1. Alternate drive currents are provided for reference only and are not a guarantee of performance.
2. Bridgelux maintains a ± 7% tolerance on flux measurements.
3. Typical stabilized DC performance values are provided as reference only and are not a guarantee of performance.

Electrical Characteristics

Table 5: Electrical Characteristics

Part Number	Drive Current (mA)	Forward Voltage Pulsed, $T_c = 25^\circ\text{C}$ (V) ^{1, 2, 3, 8}			Typical Coefficient of Forward Voltage ⁴ $\Delta V_f / \Delta T_c$ (mV/ $^\circ\text{C}$)	Typical Thermal Resistance Junction to Case ^{5,6} R_{j-c} ($^\circ\text{C}/\text{W}$)	Driver Selection Voltages ⁷ (V)	
		Minimum	Typical	Maximum			V_f Min. Hot $T_c = 105^\circ\text{C}$ (V)	V_f Max. Cold $T_c = -40^\circ\text{C}$ (V)
BXRH-xxx10xx-B-8x	350	33.9	36.6	39.3	-20.00	1.01	32.3	40.6
	600	36.5	39.5	42.5	-21.58	1.26	34.8	43.9
BXRH-xxx10xx-G-8x	700	16.9	18.3	19.7	-10.00	1.01	16.1	20.3
	1200	18.2	19.7	21.2	-10.77	1.26	17.4	21.9

Notes for Table 5:

- Parts are tested in pulsed conditions, $T_c = 25^\circ\text{C}$. Pulse width is 10ms.
- Voltage minimum and maximum are provided for reference only and are not a guarantee of performance.
- Bridgelux maintains a tester tolerance of $\pm 0.10\text{V}$ on forward voltage measurements.
- Typical coefficient of forward voltage tolerance is $\pm 0.1\text{mV}$ for nominal current.
- Thermal resistance values are based from test data of a 3000K 80 CRI product.
- Thermal resistance value was calculated using total electrical input power; optical power was not subtracted from input power. The thermal interface material used during testing is not included in the thermal resistance value.
- V_f min hot and max cold values are provided as reference only and are not guaranteed by test. These values are provided to aid in driver design and selection over the operating range of the product.
- This product has been designed and manufactured per IEC 62031:2018. This product has passed dielectric withstand voltage testing at 500 V. The working voltage designated for the insulation is 50V d.c. The maximum allowable voltage across the array must be determined in the end product application.

Eye Safety

Table 6: Eye Safety Risk Group (RG) Classifications

Part Number	Drive Current (mA)	CCT ^{1,4}	
		2700K/3000K ²	4000K ³
BXRH-xxx10xx-B-8x	285	RG1	RG1
	350	RG1	RG2
	600	RG2	RG2
BXRH-xxx10xx-G-8x	570	RG1	RG1
	700	RG1	RG2
	1200	RG2	RG2

Notes for Table 6:

1. Eye safety classification for the use of Bridgelux V Series HD LED arrays is in accordance with specification IEC/TR 62778: Application of IEC 62471 for the assessment of blue light hazard to light sources and luminaires.
2. For products classified as RG2 at 3000K, E_{Bv} = 2670 lx.
3. For products classified as RG2 at 4000K, E_{Bv} = 1760 lx.
4. Please contact your Bridgelux sales representative for E_{Bv} values at specific drive currents and CCTs not listed.

Absolute Maximum Ratings

Table 7: Maximum Ratings

Parameter	Maximum Rating	
LED Junction Temperature (T _J)	125°C	
Storage Temperature	-40°C to +105°C	
Operating Case Temperature ¹ (T _C)	105°C	
Soldering Temperature ²	350°C or lower for a maximum of 6 seconds	
	BXRH-xxx10xx-B-8x	BXRH-xxx10xx-G-8x
Maximum Drive Current ³	600 mA	1200 mA
Maximum Peak Pulsed Drive Current ⁴	680 mA	1360 mA
Maximum Reverse Voltage ⁵	-60V	-30V

Notes for Table 7:

1. For IEC 62717 requirement, please consult your Bridgelux sales representative.
2. Refer to Bridgelux Application Note AN101: Handling and Assembly of Bridgelux V Series LED Arrays.
3. Arrays may be driven at higher currents however lumen maintenance may be reduced and warranty will not apply.
4. Bridgelux recommends a maximum duty cycle of 10% and pulse width of 20 ms when operating LED Arrays at maximum peak pulsed current specified. Maximum peak pulsed currents indicate values where LED Arrays can be driven without catastrophic failures.
5. Light emitting diodes are not designed to be driven in reverse voltage and will not produce light under this condition. Maximum rating provided for reference only.

Performance Curves

Figure 1: V6B HD Drive Current vs. Voltage ($T_j = T_c = 25^\circ\text{C}$)¹

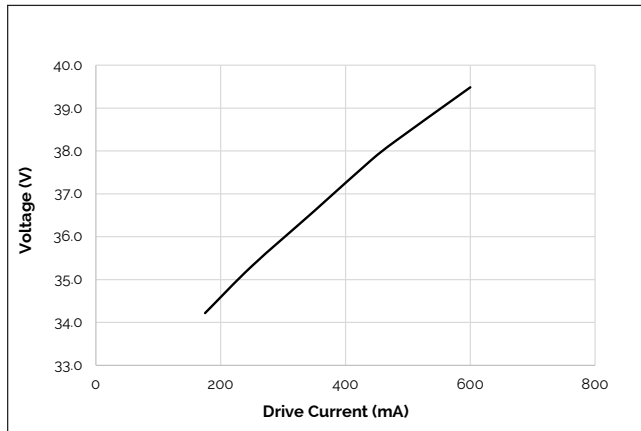

Figure 2: V6G HD Drive Current vs. Voltage ($T_j = T_c = 25^\circ\text{C}$)¹

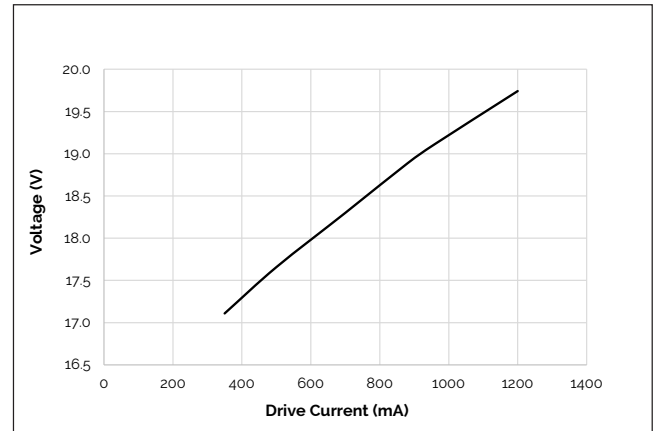

Figure 3: V6B HD Typical Relative Luminous Flux vs. Drive Current ($T_j = T_c = 25^\circ\text{C}$)¹

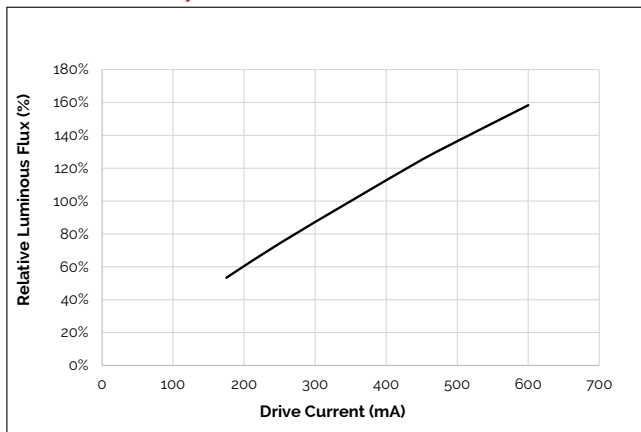

Figure 4: V6G HD Typical Relative Luminous Flux vs. Drive Current ($T_j = T_c = 25^\circ\text{C}$)¹

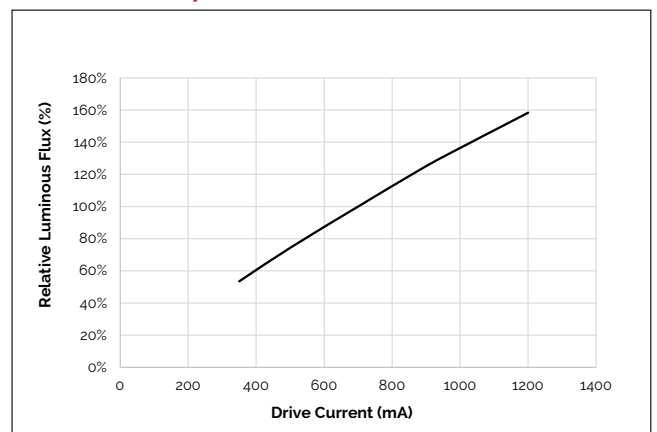

Figure 5: Typical DC Flux vs. Case Temperature

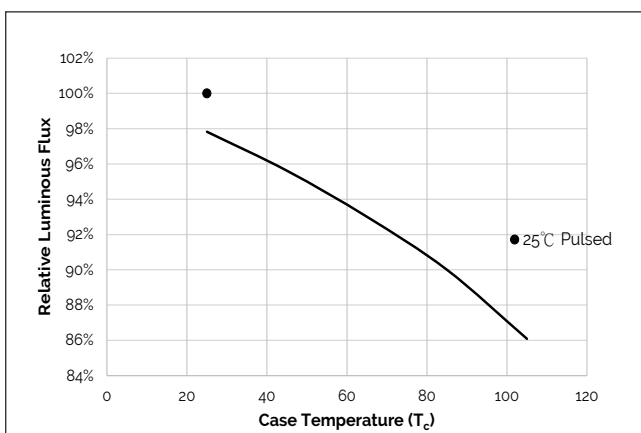
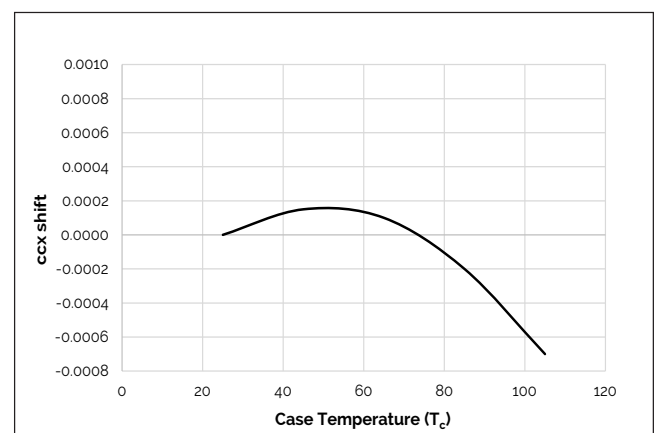

Figure 6: Typical DC ccx Shift vs. Case Temperature



Notes for Figures 1 - 6:

1. Bridgelux does not recommend driving high power LEDs at low currents. Doing so may produce unpredictable results. Pulse width modulation (PWM) is recommended for dimming effects.
2. Characteristics shown for 3000K and 90 CRI.

Performance Curves

Figure 7: Typical DC ccy Shift vs. Case Temperature

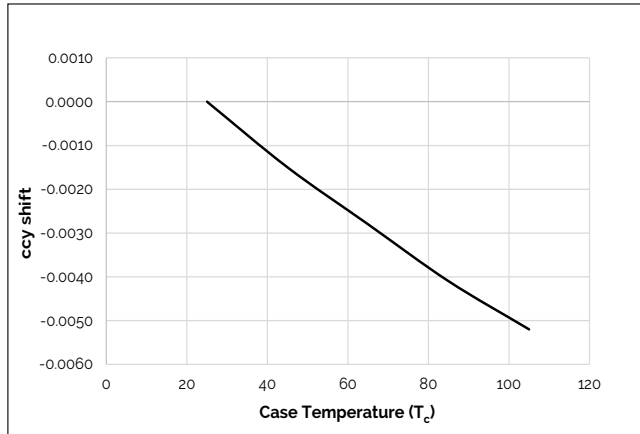
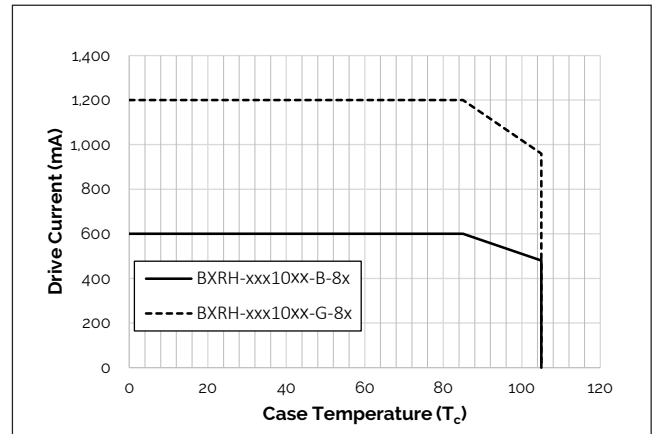

Figure 8: Derating Curve



Notes for Figure 7:

1. Bridgelux does not recommend driving high power LEDs at low currents. Doing so may produce unpredictable results. Pulse width modulation (PWM) is recommended for dimming effects.
2. Characteristics shown for 3000K and 90 CRI.

Typical Radiation Pattern

Figure 9: Typical Spatial Radiation Pattern

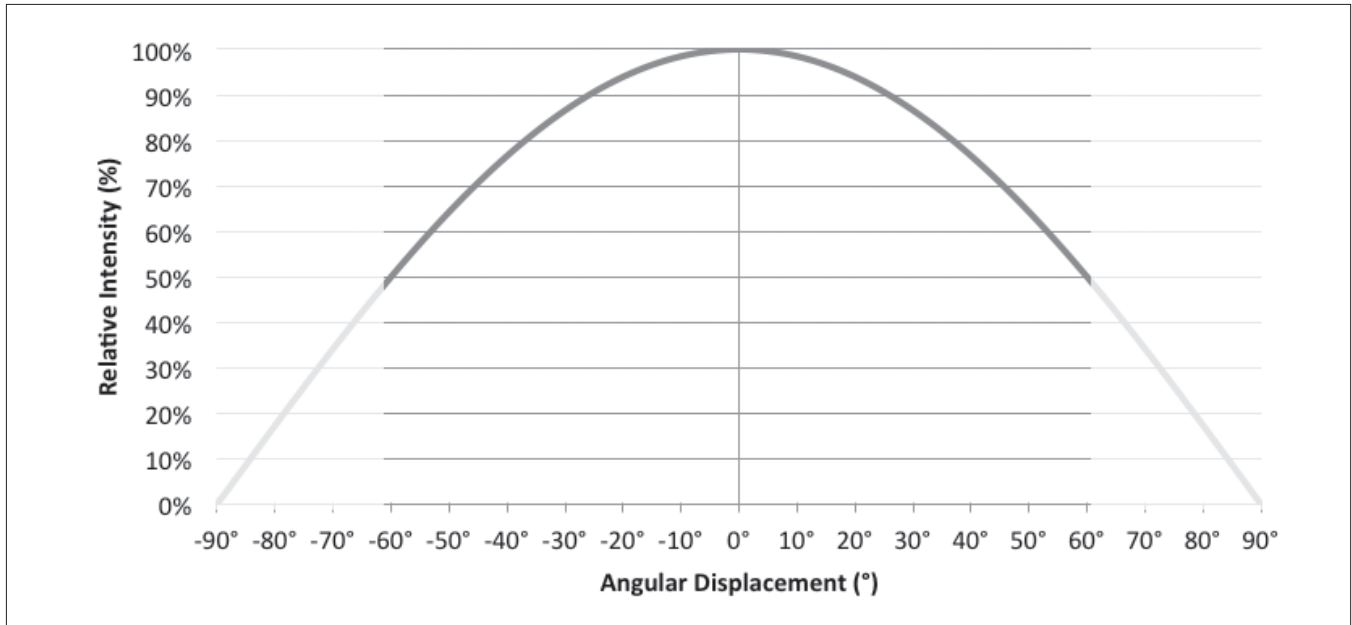

Notes for Figure 9:

1. Typical viewing angle is 120°.
2. The viewing angle is defined as the off axis angle from the centerline where intensity is ½ of the peak value.

Figure 10: Typical Polar Radiation Pattern

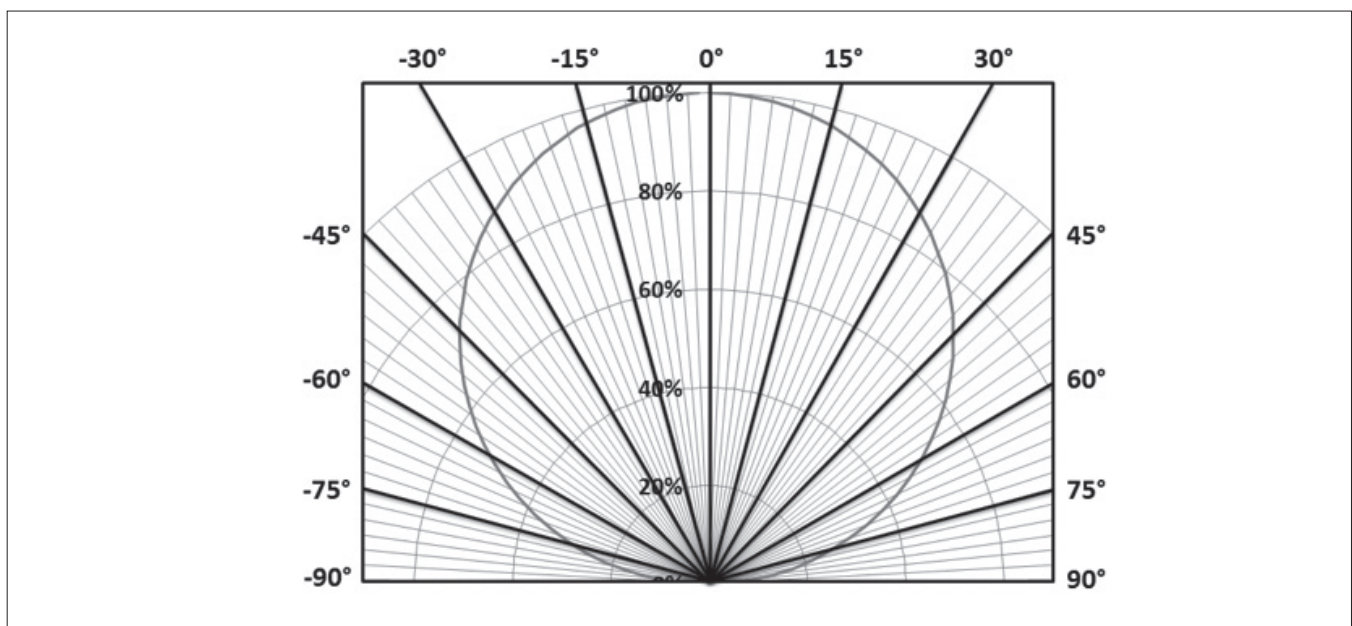

Typical Color Spectrum

Figure 11: Typical Color Spectrum

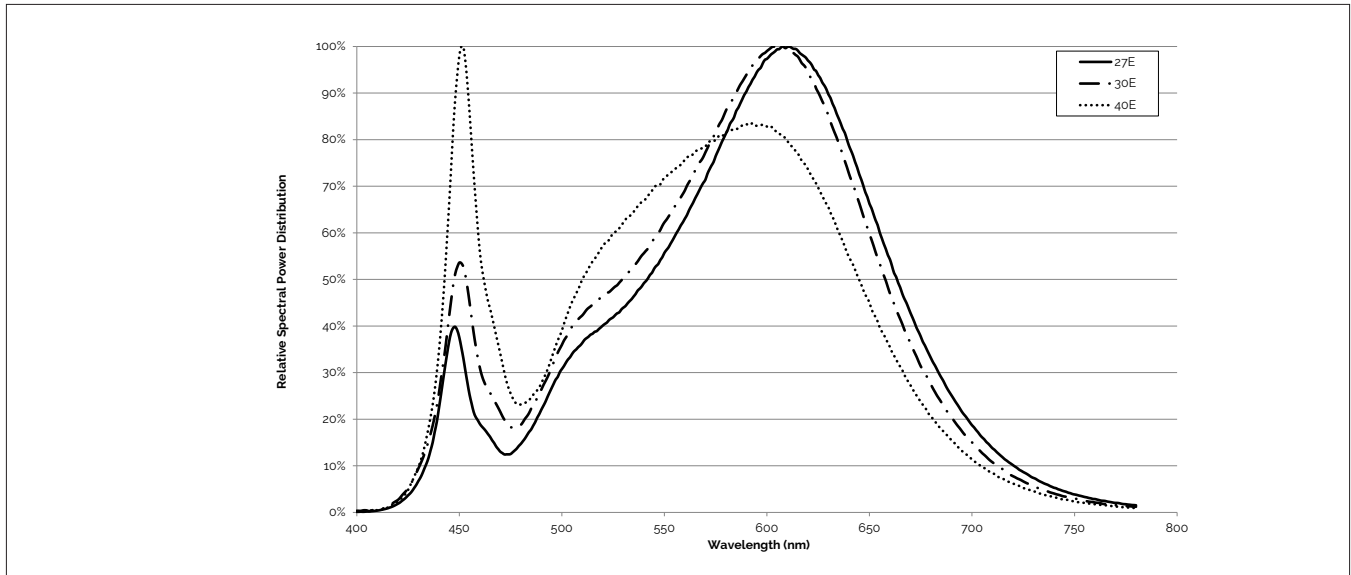

Notes for Figure 11:

1. Color spectra measured at nominal current for $T_j = T_c = 25^\circ\text{C}$.
2. Color spectra shown is 2700K and 80 CRI.
3. Color spectra shown is 3000K and 80 CRI.
4. Color spectra shown is 4000K and 80 CRI.

Figure 12: Typical Color Spectrum for Décor Series

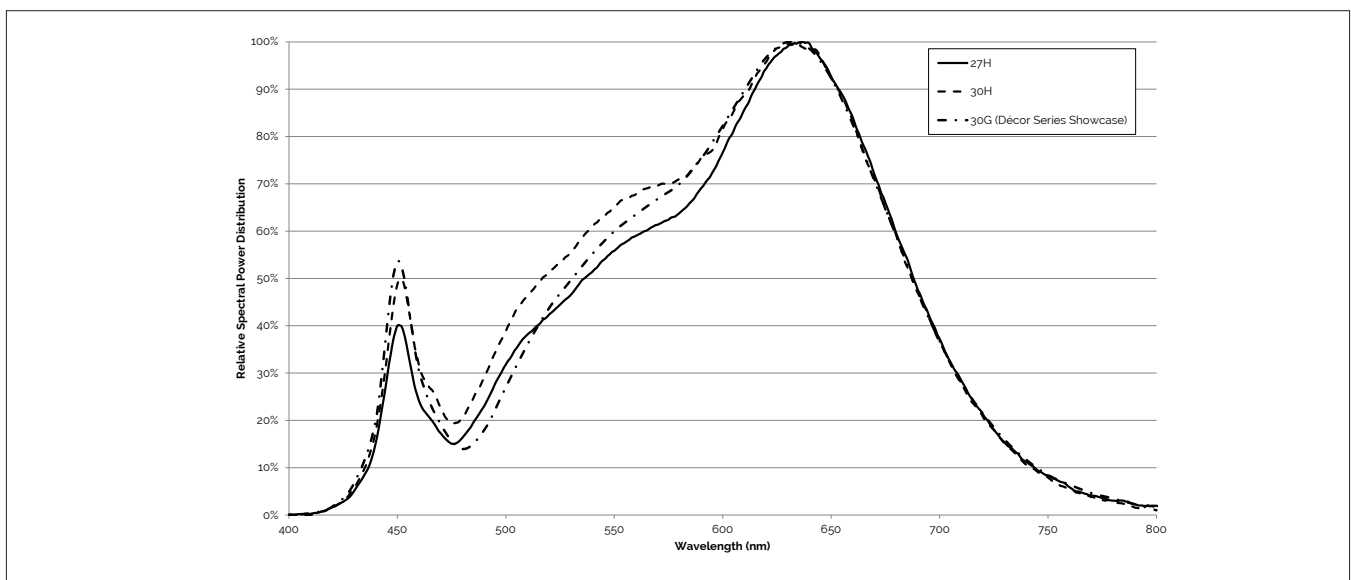

Note for Figure 12:

1. Color spectra measured at nominal current for $T_j = T_c = 25^\circ\text{C}$.

Mechanical Dimensions

Figure 13: Drawing for V6 HD LED Array

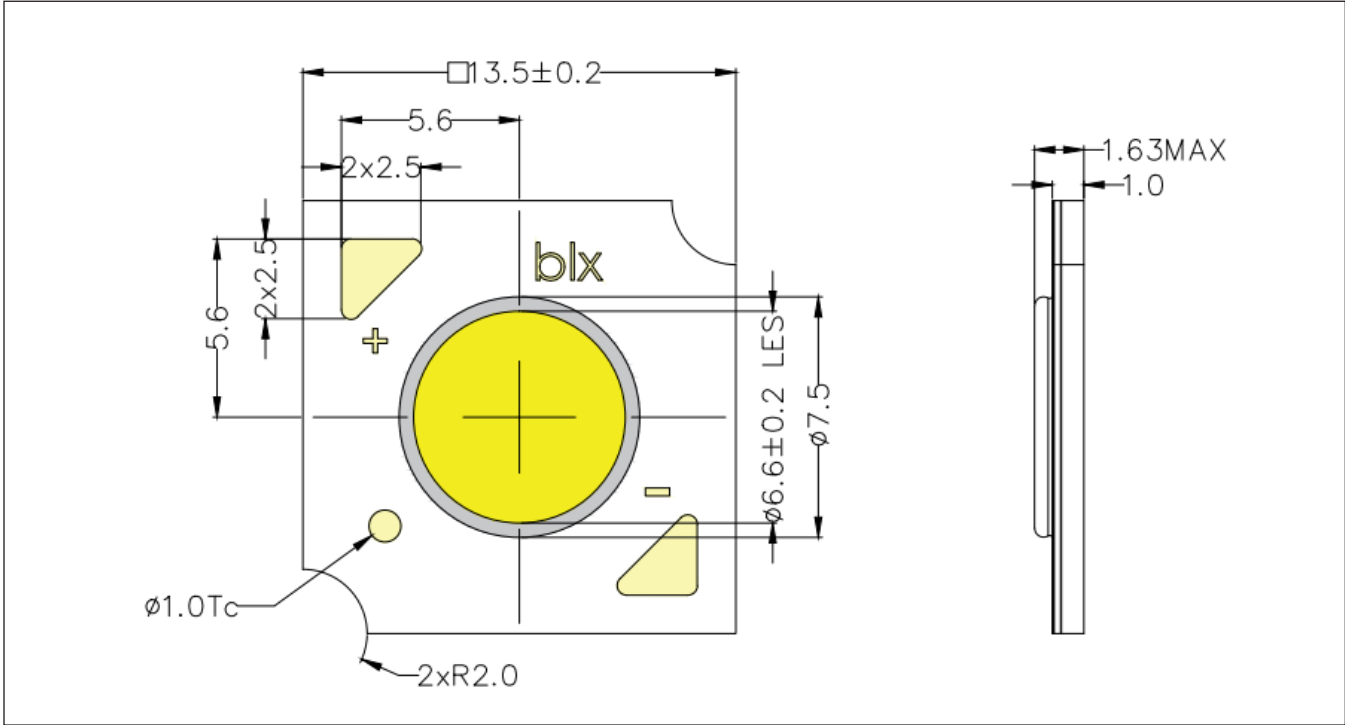

Notes for Figure 13:

1. Drawings are not to scale.
2. Drawing dimensions are in millimeters.
3. Solder pads are labeled "+" and "-" to denote positive and negative polarity, respectively.
4. Unless otherwise specified, tolerances are ± 0.1 mm.
5. Refer to Application Notes AN101 for product handling, mounting and heat sink recommendations.
6. The optical center of the LED Array is nominally defined by the mechanical center of the array to a tolerance of ± 0.2 mm.
7. Bridgelux maintains a flatness of 0.10mm across the mounting surface of the array.

Color Binning Information

Figure 14: Warm and Neutral White Test Bins in xy Color Space **Figure 15: Cool White Test Bins in xy Color Space**

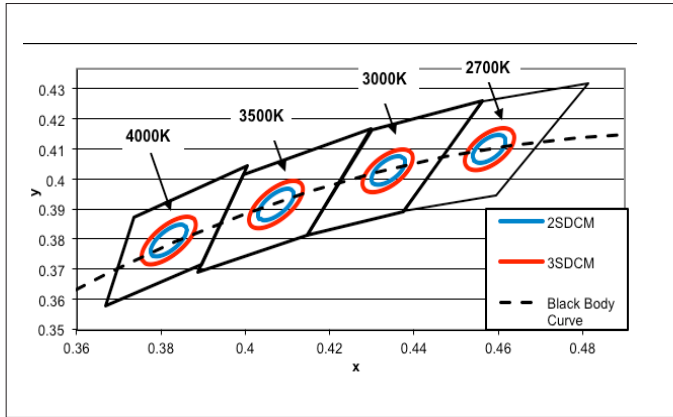

Note: Pulsed Test Conditions, $T_c = 25^\circ\text{C}$

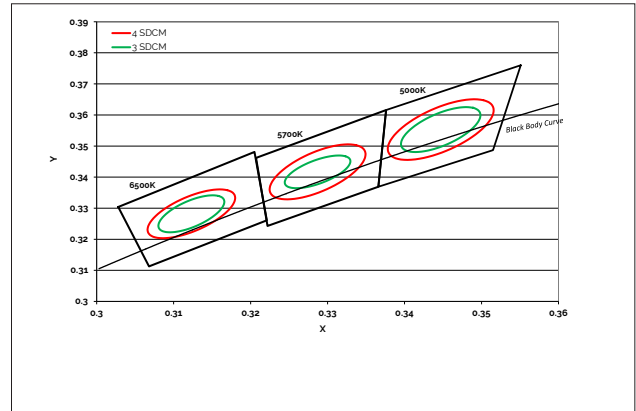

Note: Pulsed Test Conditions, $T_c = 85^\circ\text{C}$

Table 8: Warm and Neutral White xy Bin Coordinates and Associated Typical CCT

Bin Code	2200K	2400K	2700K	3000K	3500K	4000K
ANSI Bin (for reference only)	(2100K-2300K)	(2300K-2500K)	(2580K - 2870K)	(2870K - 3220K)	(3220K - 3710K)	(3710K - 4260K)
83 (3 SDCM)	(2207K-2309K)	(2336K-2454K)	(2651K - 2794K)	(2968K - 3136K)	(3369K - 3586K)	(3851K - 4130K)
82 (2 SDCM)	(2224K-2291K)	(2355K-2433K)	(2674K - 2769K)	(2995K - 3107K)	(3404K - 3548K)	(3895K - 4081K)
Center Point (x,y)	(0.5018, 0.4153)	(0.489, 0.4182)	(0.4578, 0.4101)	(0.4338, 0.403)	(0.4073, 0.3917)	(0.3818, 0.3797)

Table 9: Cool White xy Bin Coordinates and Associated Typical CCT (product is hot targeted to $T_c = 85^\circ\text{C}$)

Bin Code	5000K	5700K
ANSI Bin (for reference only)	(4745K - 5311K)	(5312K - 6022K)
84 (4 SDCM)	(4801K - 5282K)	(5395K- 5970K)
83 (3 SDCM)	(4835K - 5215K)	(5460K- 5891K)
Center Point (x,y)	(0.3447, 0.3553)	(0.3287, 0.3417)

Note for Table 8-g:

1. Bridgelux maintains a tolerance of +/- 0.007 on x and y color coordinates in the CIE 1931 color Space.

Packaging and Labeling

Figure 16: V6 HD Packaging Tube

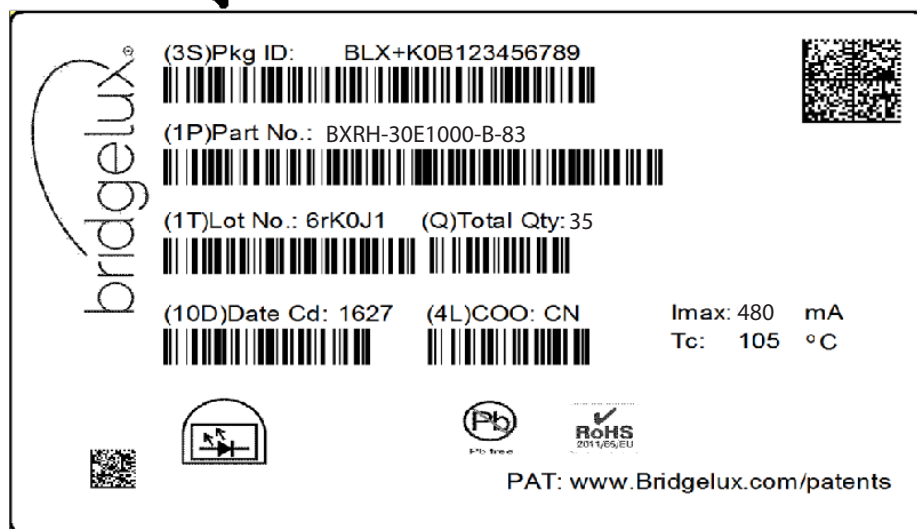

Box Label

Commercial Invoice
and Packing list



Notes for Figure 16:

1. Each tube holds 35 V6 HD COB arrays.
2. One tube is sealed in an anti-static bag. Four bags are placed in a shipping box. Depending on quantities ordered, a bigger shipping box, containing four boxes may be used to ship products.
3. Each bag and box is to be labeled as shown above.
4. Dimensions for each tube are 15.4 (W) x 8.3 (H) x 430 (L) mm. Dimensions for the anti-static bag are 75 (W) x 615 (L) x 0.075 (T) mm. Dimensions for the shipping box are 58.7 x 13.3 x 7.9 cm

Packaging and Labeling

Figure 17: V Series HD Product Labeling

Bridgelux COB arrays have laser markings on the back side of the substrate to help with product identification. In addition to the product identification markings, Bridgelux COB arrays also contain markings for internal Bridgelux manufacturing use only. The image below shows which markings are for customer use and which ones are for Bridgelux internal use only. The Bridgelux internal manufacturing markings are subject to change without notice, however these will not impact the form, function or performance of the COB array.



Design Resources

Application Notes

Bridgelux has developed a comprehensive set of application notes and design resources to assist customers in successfully designing with the V Series product family of LED array products. For all available application notes visit www.bridgelux.com.

Optical Source Models

Optical source models and ray set files are available for all Bridgelux products. For a list of available formats, visit www.bridgelux.com.

3D CAD Models

Three dimensional CAD models depicting the product outline of all Bridgelux V Series HD LED arrays are available in both IGS and STEP formats. Please contact your Bridgelux sales representative for assistance.

LM80

LM80 testing has been completed and the LM80 report is now available. Please contact your Bridgelux sales representatives for LM-80 report.

Precautions

CAUTION: CHEMICAL EXPOSURE HAZARD

Exposure to some chemicals commonly used in luminaire manufacturing and assembly can cause damage to the LED array. Please consult Bridgelux Application Note AN101 for additional information.

CAUTION: RISK OF BURN

Do not touch the V Series HD LED array during operation. Allow the array to cool for a sufficient period of time before handling. The V Series HD LED array may reach elevated temperatures such that could burn skin when touched.

CAUTION

CONTACT WITH LIGHT EMITTING SURFACE (LES)

Avoid any contact with the LES. Do not touch the LES of the LED array or apply stress to the LES (yellow phosphor resin area). Contact may cause damage to the LED array.

Optics and reflectors must not be mounted in contact with the LES (yellow phosphor resin area).

Disclaimers

MINOR PRODUCT CHANGE POLICY

The rigorous qualification testing on products offered by Bridgelux provides performance assurance. Slight cosmetic changes that do not affect form, fit, or function may occur as Bridgelux continues product optimization.

STANDARD TEST CONDITIONS

Unless otherwise stated, array testing is performed at the nominal drive current.

About Bridgelux: Bridging Light and Life™

At Bridgelux, we help companies, industries and people experience the power and possibility of light. Since 2002, we've designed LED solutions that are high performing, energy efficient, cost effective and easy to integrate. Our focus is on light's impact on human behavior, delivering products that create better environments, experiences and returns—both experiential and financial. And our patented technology drives new platforms for commercial and industrial luminaires.

For more information about the company, please visit
bridgelux.com
twitter.com/Bridgelux
facebook.com/Bridgelux
youtube.com/user/Bridgelux
linkedin.com/company/bridgelux-inc-_2
WeChat ID: BridgeluxInChina



46410 Fremont Boulevard
Fremont, CA 94538 USA
Tel (925) 583-8400
www.bridgelux.com

© 2025 Bridgelux, Inc. All rights reserved. Product specifications are subject to change without notice. Bridgelux, the Bridgelux stylized logo design, Vero, V Series and V Series HD are registered trademarks, and Decor Series is a trademark of Bridgelux, Inc. All other trademarks are the property of their respective owners.

Bridgelux Gen 8 V6 HD Array Series Product Data Sheet DS407 Rev. E (10/2025)