

# Bridgelux® SMD 2835 1W 9V

Product Data Sheet DS257

# Introduction

SMD 2835



## Features

- Industry-standard 2835 footprint
- 9 bin color control
- Hot-color targeting ensures that color is within the ANSI bin at the typical application conditions of 85°C
- RoHS compliant and lead free
- Multiple CCT configurations for a wide range of lighting applications

## Benefits

- Lower operating and manufacturing cost
- Ease of design and rapid go-to-market
- Uniform, consistent white light
- Reliable and constant white point
- Compliant with environmental standards
- Design flexibility

# Contents

Product Feature Map	2
Product Nomenclature	2
Product Selection Guide	3
Electrical Characteristics	4
Absolute Maximum Ratings	5
Product Bin Definitions	6
Performance Curves	9
Typical Radiation Pattern	12
Typical Color Spectrum	13
Mechanical Dimensions	14
Reliability	15
Reflow Characteristics	16
Packaging	17
Design Resources	19
Precautions	19
Disclaimers	19
About Bridgelux	20

# Product Feature Map

Bridgelux SMD LED products come in industry standard package sizes and follow ANSI binning standards. These LEDs are optimized for cost and performance, helping to ensure highly competitive system lumen per dollar performance while addressing the stringent efficacy and reliability standards required for modern lighting applications.

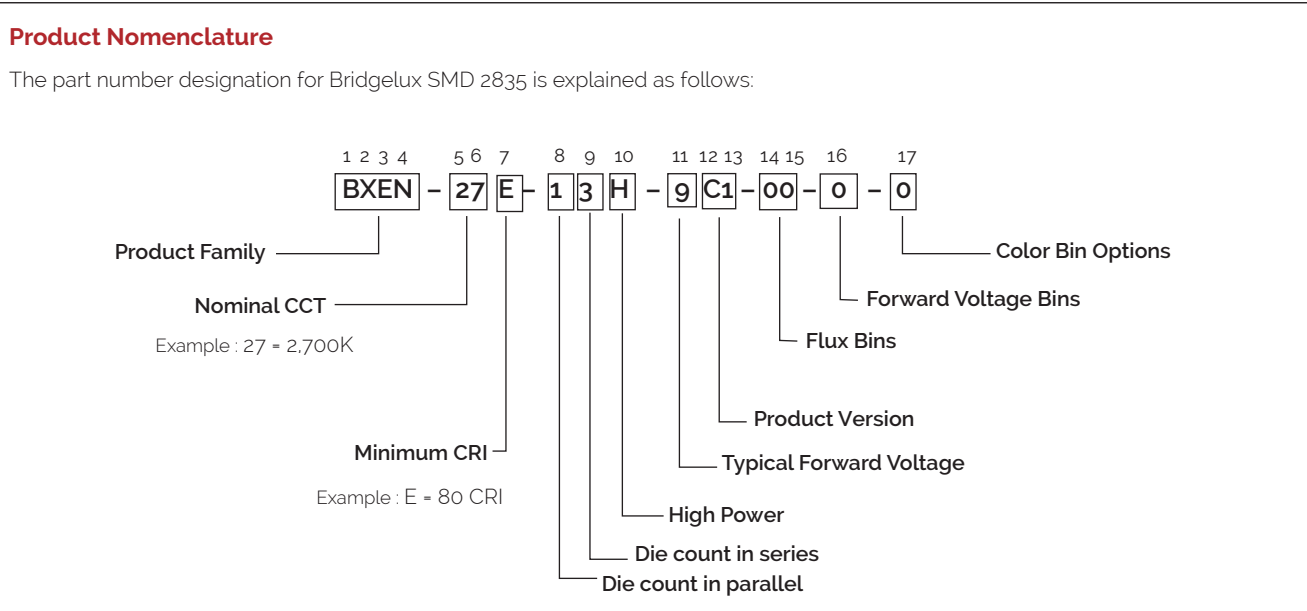
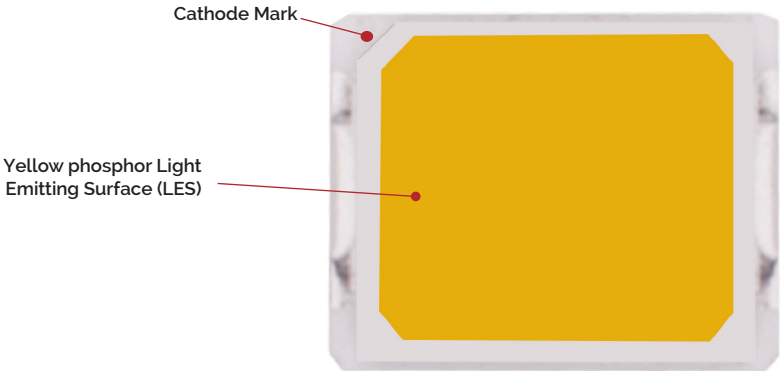

# Product Selection Guide

The following product configurations are available:

**Table 1:** Selection Guide, Pulsed Measurement Data at 100mA ( $T_j = T_{sp} = 25^\circ\text{C}$ )

Part Number <sup>1,6</sup>	Nominal CCT <sup>2</sup> (K)	CRI <sup>3,5</sup>	Nominal Drive Current (mA)	Forward Voltage <sup>4,5</sup> (V)			Typical Pulsed Flux (lm) <sup>4,5</sup>	Typical Power (W)	Typical Efficacy (lm/W)
				Min	Typical	Max			
BXEN-27E-13H-gC1-00-0-0	2700	80	100	8.8	9.1	9.6	128.0	0.9	141
BXEN-28E-13H-gC1-00-0-0	2700	80	100	8.8	9.1	9.6	128.0	0.9	141
BXEN-30E-13H-gC1-00-0-0	3000	80	100	8.8	9.1	9.6	133.0	0.9	146
BXEN-35E-13H-gC1-00-0-0	3500	80	100	8.8	9.1	9.6	133.0	0.9	146
BXEN-40E-13H-gC1-00-0-0	4000	80	100	8.8	9.1	9.6	138.0	0.9	152
BXEN-50E-13H-gC1-00-0-0	5000	80	100	8.8	9.1	9.6	138.0	0.9	152
BXEN-57E-13H-gC1-00-0-0	5700	80	100	8.8	9.1	9.6	138.0	0.9	152
BXEN-65E-13H-gC1-00-0-0	6500	80	100	8.8	9.1	9.6	138.0	0.9	152
BXEN-64E-13H-gC1-00-0-0	6500	80	100	8.8	9.1	9.6	138.0	0.9	152

**Table 2:** Selection Guide, Pulsed Test Performance ( $T_{sp} = 85^\circ\text{C}$ )<sup>7,8</sup>

Part Number <sup>1,6</sup>	Nominal CCT <sup>2</sup> (K)	CRI <sup>3,5</sup>	Nominal Drive Current (mA)	Forward Voltage <sup>4,5</sup> (V)			Typical Pulsed Flux (lm) <sup>4,5</sup>	Typical Power (W)	Typical Efficacy (lm/W)
				Min	Typical	Max			
BXEN-27E-13H-gC1-00-0-0	2700	80	100	8.6	8.9	9.4	112.9	0.9	127
BXEN-28E-13H-gC1-00-0-0	2700	80	100	8.6	8.9	9.4	112.9	0.9	127
BXEN-30E-13H-gC1-00-0-0	3000	80	100	8.6	8.9	9.4	117.3	0.9	132
BXEN-35E-13H-gC1-00-0-0	3500	80	100	8.6	8.9	9.4	117.3	0.9	132
BXEN-40E-13H-gC1-00-0-0	4000	80	100	8.6	8.9	9.4	121.7	0.9	137
BXEN-50E-13H-gC1-00-0-0	5000	80	100	8.6	8.9	9.4	121.7	0.9	137
BXEN-57E-13H-gC1-00-0-0	5700	80	100	8.6	8.9	9.4	121.7	0.9	137
BXEN-65E-13H-gC1-00-0-0	6500	80	100	8.6	8.9	9.4	121.7	0.9	137
BXEN-64E-13H-gC1-00-0-0	6500	80	100	8.6	8.9	9.4	121.7	0.9	137

Notes for Tables 1 & 2:

- The last 6 characters (including hyphens '-') refer to flux bins, forward voltage bins, and color bin options, respectively. "00-0-0" denotes the full distribution of flux, forward voltage, and color bin.  
Example: BXEN-27E-13H-gC1-00-0-0 refers to the full distribution of flux, forward voltage, and color within a 2700K 7-step ANSI standard chromaticity region with a minimum of 80CRI, 1x3 die configuration, high power, 9.1V typical forward voltage.
- Product CCT is hot targeted at  $T_{sp} = 85^\circ\text{C}$ . Nominal CCT as defined by ANSI C78.377-2011.
- Listed CRIs are minimum values.
- Products tested under pulsed condition (10ms pulse width) at nominal drive current.
- Bridgelux maintains a  $\pm 7.5\%$  tolerance on luminous flux measurements,  $\pm 0.1\text{V}$  tolerance on forward voltage measurements, and  $\pm 2$  tolerance on CRI measurements for the SMD 2835.
- Refer to Table 5 and Table 6 for Bridgelux SMD 2835 Luminous Flux Binning and Forward Voltage Binning information.
- Typical pulsed test performance values are provided as reference only and are not a guarantee of performance.
- Typical performance is estimated based on operation under pulsed current with LED emitter mounted onto a heat sink with thermal interface material and the solder point temperature maintained at  $85^\circ\text{C}$ . Based on Bridgelux test setup, values may vary depending on the thermal design of the luminaire and the exposed environment to which the product is subjected.

# Electrical Characteristics

**Table 3:** Electrical Characteristics

Part Number	Drive Current (mA)	Forward Voltage (V) <sup>1,2</sup>			Typical Temperature Coefficient of Forward Voltage $\Delta V_f / \Delta T$ (mV/°C)	Typical Thermal Resistance Junction to Solder Point <sup>3</sup> $R_{j-sp}$ (°C/W)
		Minimum	Typical	Maximum		
BXEN-XXX-13H-gC1-00-0-0	100	8.8	9.1	9.6	-3.53	14

Notes for Table 3:

1. Bridgelux maintains a tolerance of  $\pm 0.1V$  on forward voltage measurements. Voltage minimum and maximum values at the nominal drive current are guaranteed by 100% test.
2. Products tested under pulsed condition (10ms pulse width) at nominal drive current where  $T_{sp} = 25^\circ C$ .
3. Thermal resistance value was calculated using total electrical input power; optical power was not subtracted from input power.

# Absolute Maximum Ratings

**Table 4:** Maximum Ratings

Parameter	Maximum Rating
LED Junction Temperature ( $T_j$ )	125°C
Storage Temperature	-40°C to +105°C
Operating Solder Point Temperature ( $T_{sp}$ )	-40°C to +105°C
Soldering Temperature	260°C or lower for a maximum of 10 seconds
Maximum Drive Current	120mA
Maximum Peak Pulsed Forward Current <sup>1</sup>	240mA
Maximum Reverse Voltage <sup>2</sup>	-
Moisture Sensitivity Rating	MSL 3
Electrostatic Discharge	2kV HBM. JEDEC-JS-001-HBM and JEDEC-JS-001-2012

Notes for Table 4:

1. Bridgelux recommends a maximum duty cycle of 10% and pulse width of 10 ms when operating LED SMD at maximum peak pulsed current specified. Maximum peak pulsed current indicate values where LED SMD can be driven without catastrophic failures.
2. Light emitting diodes are not designed to be driven in reverse voltage and will not produce light under this condition. no rating is provided

# Product Bin Definitions

Table 5 lists the standard photometric luminous flux bins for Bridgelux SMD 2835 LEDs. Although several bins are listed, product availability in a particular bin varies by production run and by product performance. Not all bins are available in all CCTs.

**Table 5:** Luminous Flux Bin Definitions at 100mA,  $T_{sp}=25^{\circ}\text{C}$

Bin Code	Minimum	Maximum	Unit	Condition
5G	120	125	lm	$I_F=100\text{mA}$
5H	125	130		
5J	130	135		
5K	135	140		
5L	140	145		
5M	145	150		

Note for Table 5:

1. Bridgelux maintains a tolerance of  $\pm 7.5\%$  on luminous flux measurements.

**Table 6:** Forward Voltage Bin Definition at 100mA,  $T_{sp}=25^{\circ}\text{C}$

Bin Code	Minimum	Maximum	Unit	Condition
T	8.6	8.8	V	$I_F=100\text{mA}$
U	8.8	9.0		
V	9.0	9.2		
W	9.2	9.4		
X	9.4	9.6		

Note for Table 6:

1. Bridgelux maintains a tolerance of  $\pm 0.1\text{V}$  on forward voltage measurements.

# Product Bin Definitions

**Table 7:** MacAdam Ellipse Color Bin Definitions

CCT	Color Space	Center Point		Major Axis	Minor Axis	Ellipse Rotation Angle	Color Bin
		X	Y				
2700K	3 SDCM	0.4578	0.4101	0.0081	0.0042	53.7	1
	5 SDCM	0.4578	0.4101	0.0135	0.007	53.7	A/B/C/D
2700K IEC	3 SDCM	0.4630	0.4200	0.0081	0.0042	53.7	1
	5 SDCM	0.4630	0.4200	0.0135	0.007	53.7	A/B/C/D
3000K	3 SDCM	0.4338	0.4030	0.00834	0.00408	53.22	1
	5 SDCM	0.4338	0.4030	0.01390	0.00680	53.22	A/B/C/D
3500K	3 SDCM	0.4073	0.3917	0.00927	0.00414	54.00	1
	5 SDCM	0.4073	0.3917	0.01545	0.00690	54.00	A/B/C/D
4000K	3 SDCM	0.3818	0.3797	0.00939	0.00402	53.72	1
	5 SDCM	0.3818	0.3797	0.01565	0.00670	53.72	A/B/C/D
5000K	3 SDCM	0.3447	0.3553	0.00822	0.00354	59.62	1
	5 SDCM	0.3447	0.3553	0.01370	0.00590	59.62	A/B/C/D
5700K	3 SDCM	0.3287	0.3417	0.00497	0.00213	59.09	1
	5 SDCM	0.3287	0.3417	0.01243	0.00533	59.09	A/B/C/D
6500K	3 SDCM	0.3123	0.3282	0.00669	0.00285	58.57	1
	5 SDCM	0.3123	0.3282	0.01115	0.00475	58.57	A/B/C/D
6500K IEC	3 SDCM	0.3130	0.3170	0.00669	0.00285	58.57	1
	5 SDCM	0.3130	0.3170	0.01115	0.00475	58.57	A/B/C/D

Point	2700K		2700K IEC		3000K		3500K		4000K		5000K		5700K		6500K		6500K IEC		Color Bin
	x	y	x	y	x	y	x	y	x	y	x	y	x	y	x	y	x	y	
ANSI	0.4813	0.4319	0.4865	0.4418	0.4562	0.4260	0.4299	0.4165	0.4006	0.4044	0.3551	0.3760	0.3376	0.3616	0.3205	0.3481	0.3212	0.3369	E/F/ G/H
	0.4562	0.426	0.4614	0.4359	0.4299	0.4165	0.3996	0.4015	0.3736	0.3874	0.3376	0.3616	0.3207	0.3462	0.3028	0.3304	0.3035	0.3192	
	0.4373	0.3893	0.4425	0.3992	0.4147	0.3814	0.3889	0.3690	0.3670	0.3578	0.3366	0.3369	0.3222	0.3243	0.3068	0.3113	0.3075	0.3001	
	0.4593	0.3944	0.4645	0.4043	0.4373	0.3893	0.4147	0.3814	0.3898	0.3716	0.3515	0.3487	0.3366	0.3369	0.3221	0.3261	0.3228	0.3149	
V-up	0.4687	0.4289	0.4740	0.4389	0.4431	0.4213	0.4148	0.4090	0.3871	0.3959	0.3463	0.3687	0.3290	0.3538	0.3115	0.3391	0.3124	0.3281	
	0.4618	0.4170	0.4673	0.4268	0.4377	0.4101	0.4112	0.3996	0.3847	0.3873	0.3457	0.3617	0.3290	0.3470	0.3124	0.3328	0.3132	0.3217	
V-down	0.4483	0.3919	0.4535	0.4018	0.4260	0.3854	0.4018	0.3752	0.3784	0.3647	0.3440	0.3427	0.3290	0.3300	0.3144	0.3186	0.3152	0.3075	
	0.4542	0.4031	0.4597	0.4130	0.4310	0.3960	0.4053	0.3844	0.3807	0.3730	0.3445	0.3495	0.3290	0.3369	0.3135	0.3250	0.3143	0.3139	
H-left	0.4468	0.4077	0.4520	0.4176	0.4223	0.3990	0.3941	0.3848	0.3702	0.3722	0.3371	0.3490	0.3215	0.3350	0.3048	0.3207	0.3055	0.3097	
	0.4524	0.4089	0.4577	0.4190	0.4283	0.4013	0.4012	0.3885	0.3755	0.3755	0.3395	0.3509	0.3240	0.3372	0.3081	0.3240	0.3088	0.3129	
H-right	0.4703	0.4132	0.4755	0.4231	0.4468	0.4077	0.4223	0.3990	0.3950	0.3875	0.3533	0.3620	0.3371	0.3490	0.3213	0.3373	0.3220	0.3259	
	0.4632	0.4115	0.4685	0.4215	0.4394	0.4052	0.4133	0.3945	0.3880	0.3834	0.3498	0.3592	0.3334	0.3456	0.3165	0.3325	0.3172	0.3212	
Center	0.4578	0.4101	0.4630	0.4200	0.4338	0.4030	0.4073	0.3917	0.3818	0.3797	0.3447	0.3553	0.3287	0.3417	0.3123	0.3282	0.3130	0.3170	

Notes for Table 7:

1. Color binning at  $T_{sp} = -85^{\circ}\text{C}$  unless otherwise specified
2. Bridgelux maintains a tolerance of  $\pm 0.007$  on x and y color coordinates in the CIE 1931 color space.

# Product Bin Definitions

**Figure 1: C.I.E. 1931 Chromaticity Diagram (g Color Bin Structure, Hot-color Targeted at  $T_{sp} = 85^{\circ}\text{C}$ )**

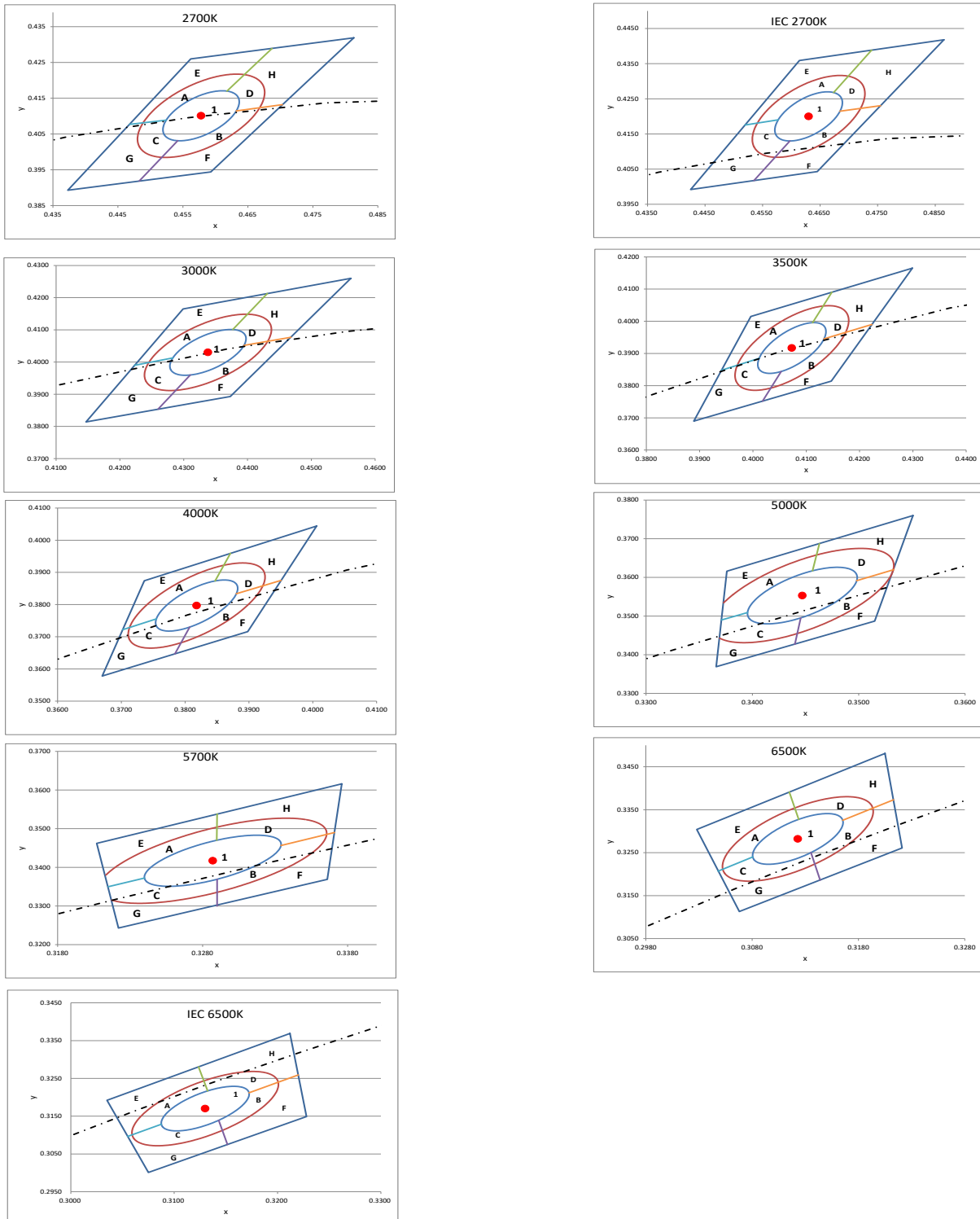

# Performance Curves

**Figure 2: Drive Current vs. Forward Voltage ( $T_{sp}=25^{\circ}\text{C}$ )**

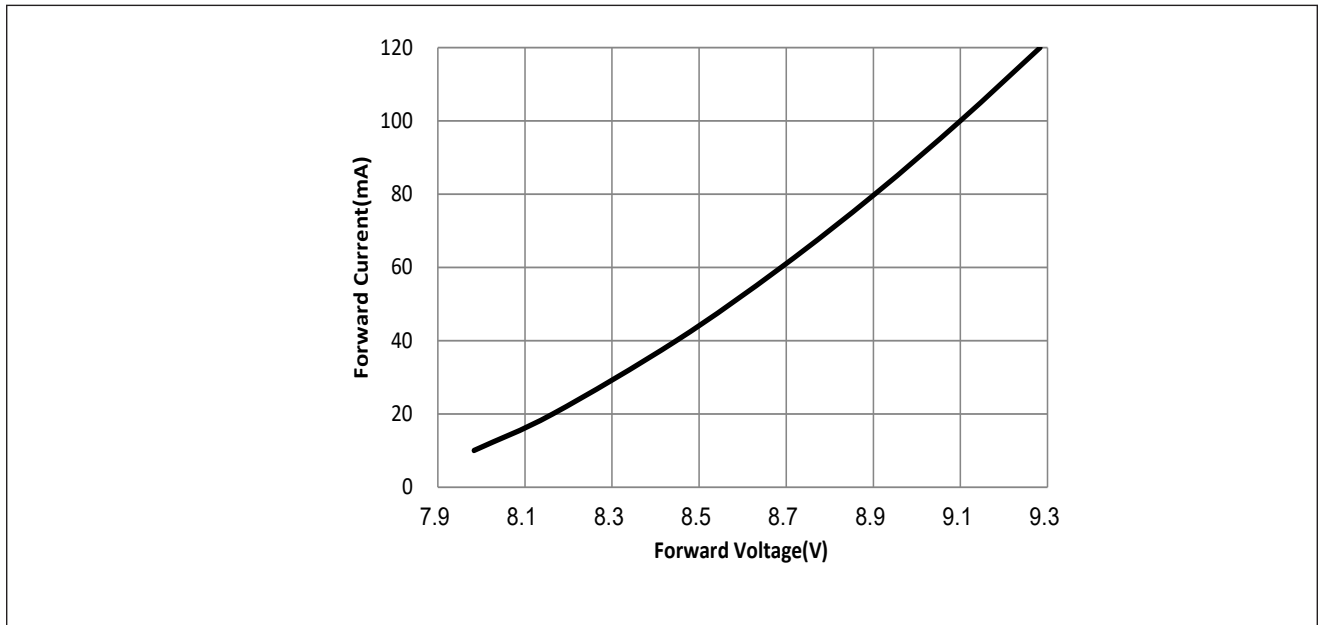

**Figure 3: Typical Relative Luminous Flux vs. Forward Current ( $T_{sp}=25^{\circ}\text{C}$ )**

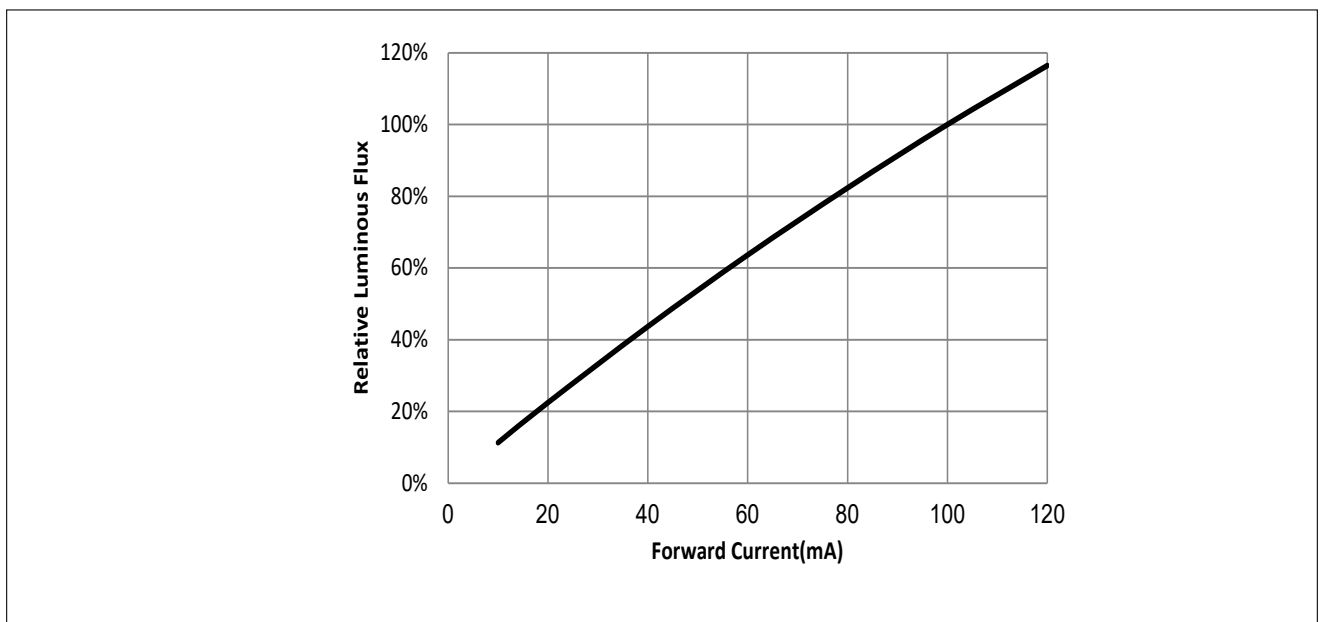

Note for Figure 3:

1. Pulse width modulation (PWM) is recommended for dimming effects.

# Performance Curves

**Figure 4: Typical Relative Flux vs. Solder Point Temperature**

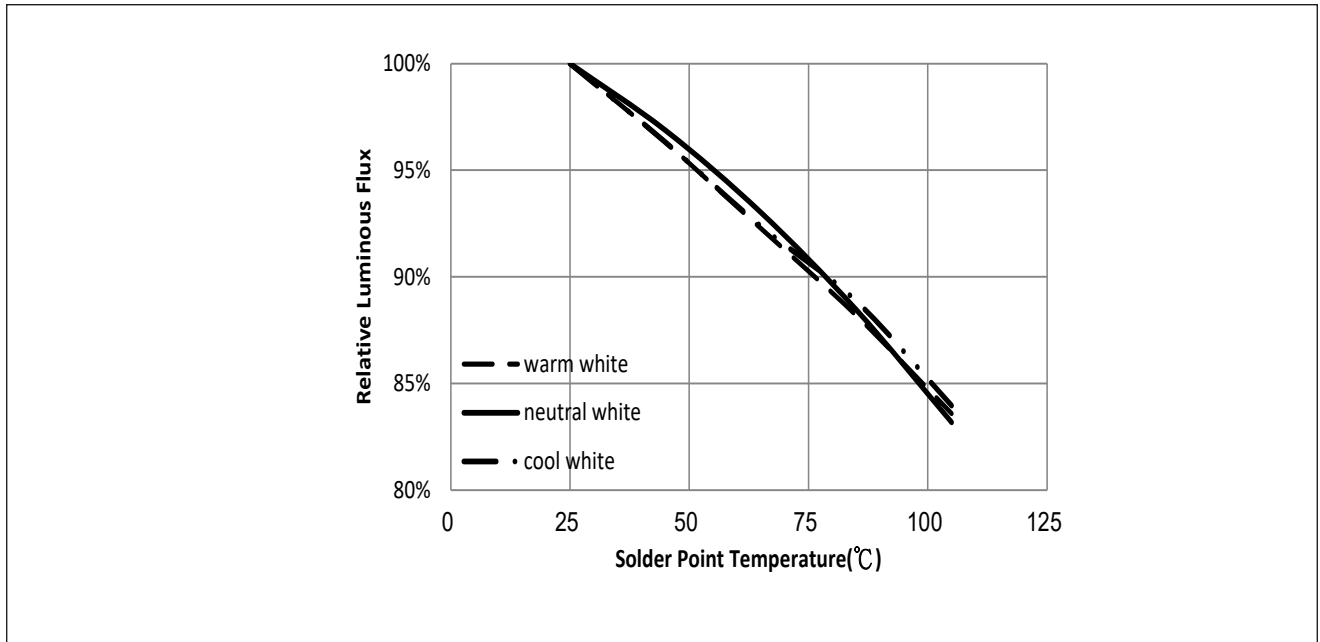

**Figure 5: Typical ccx Shift vs. Solder Point Temperature**

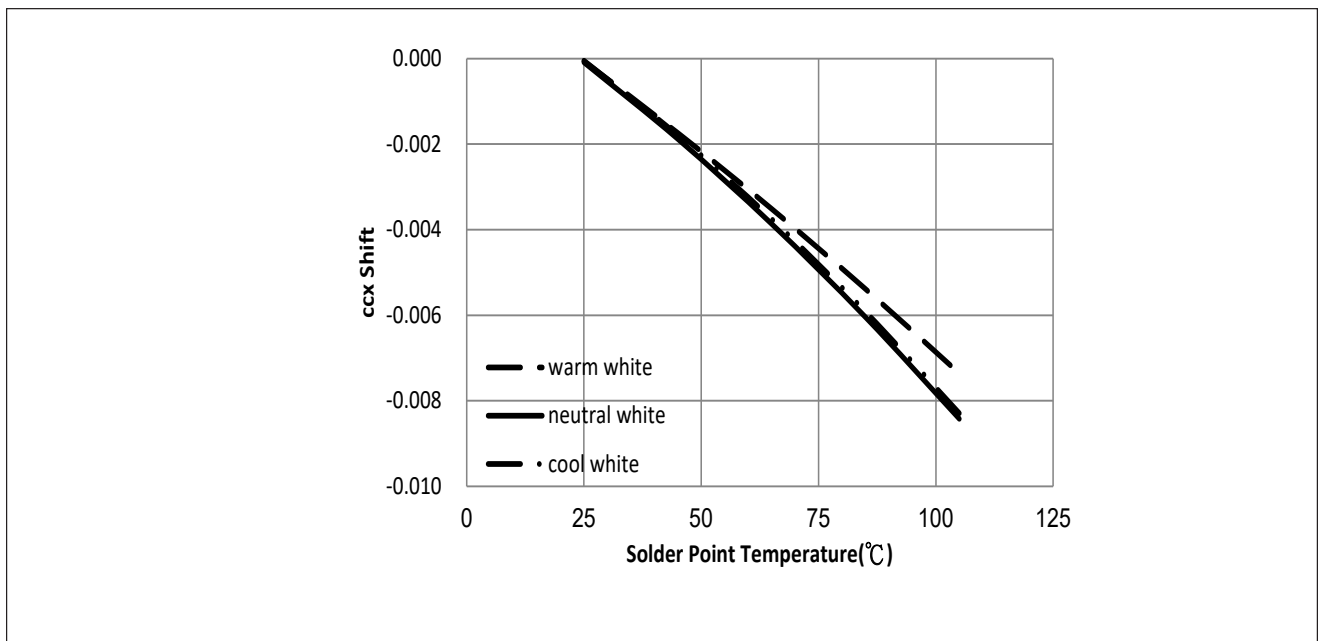

Notes for Figures 4 & 5:

1. Characteristics shown for warm white based on 2700K and 80 CRI.
2. Characteristics shown for neutral white based on 4000K and 80 CRI.
3. Characteristics shown for cool white based on 6500K and 80 CRI.
4. For other color SKUs, the shift in color will vary. Please contact your Bridgelux Sales Representative for more information

# Performance Curves

**Figure 6: Typical ccy Shift vs. Solder Point Temperature**

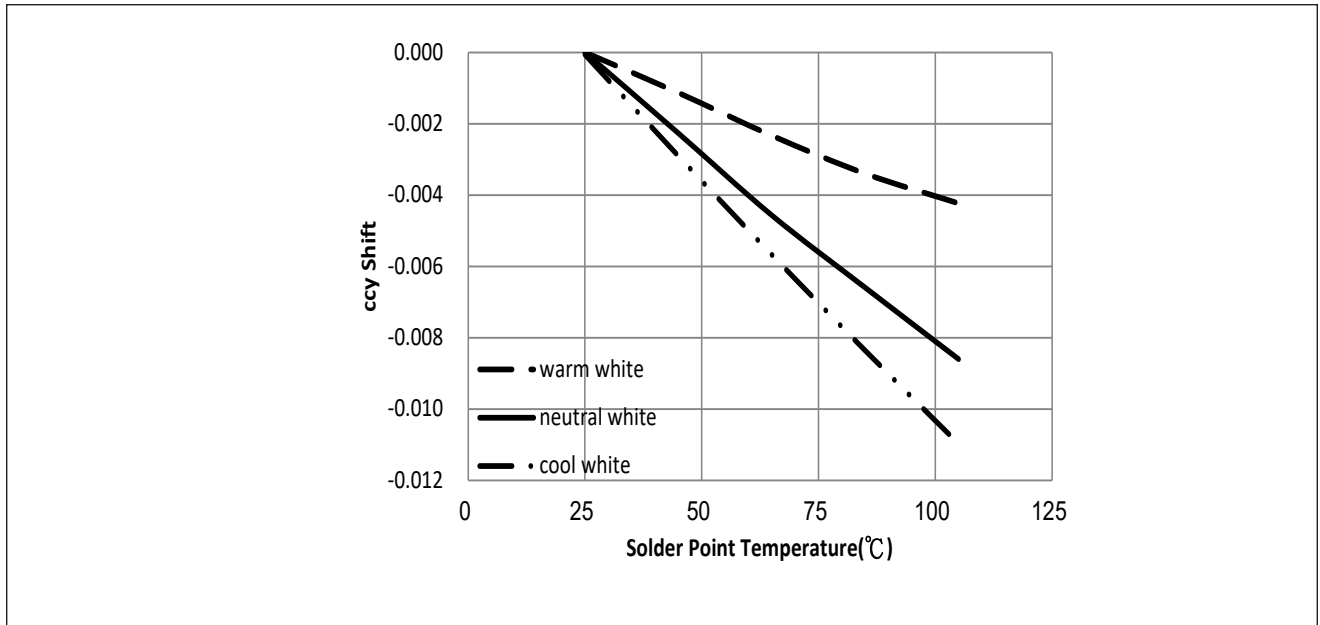

Notes for Figure 6:

1. Characteristics shown for warm white based on 2700K and 80 CRI.
2. Characteristics shown for neutral white based on 4000K and 80 CRI.
3. Characteristics shown for cool white based on 6500K and 80 CRI.
4. For other color SKUs, the shift in color will vary. Please contact your Bridgelux Sales Representative for more information.

# Typical Radiation Pattern

**Figure 7: Typical Spatial Radiation Pattern at 100mA,  $T_{sp} = -25^{\circ}\text{C}$**

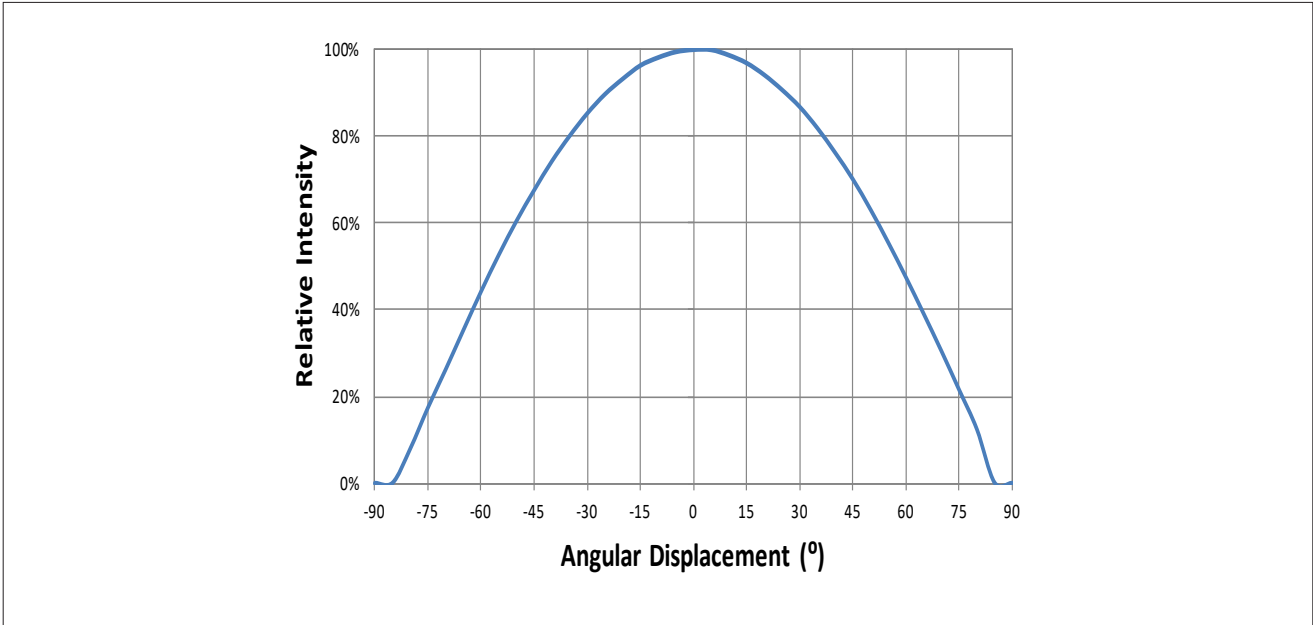

Notes for Figure 7:

1. Typical viewing angle is  $120^{\circ}$ .
2. The viewing angle is defined as the off axis angle from the centerline where luminous intensity (Iv) is  $\frac{1}{2}$  of the peak value.

**Figure 8: Typical Polar Radiation Pattern at 100mA,  $T_{sp} = -25^{\circ}\text{C}$**

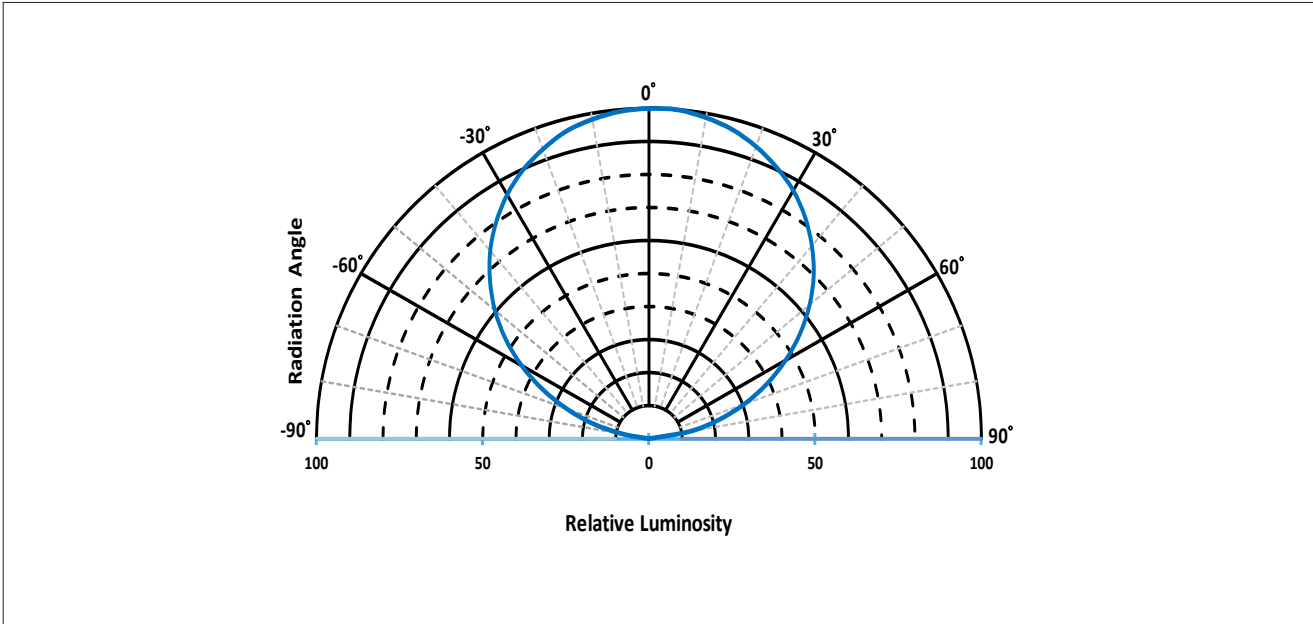

# Typical Color Spectrum

Figure 9: Typical Color Spectrum

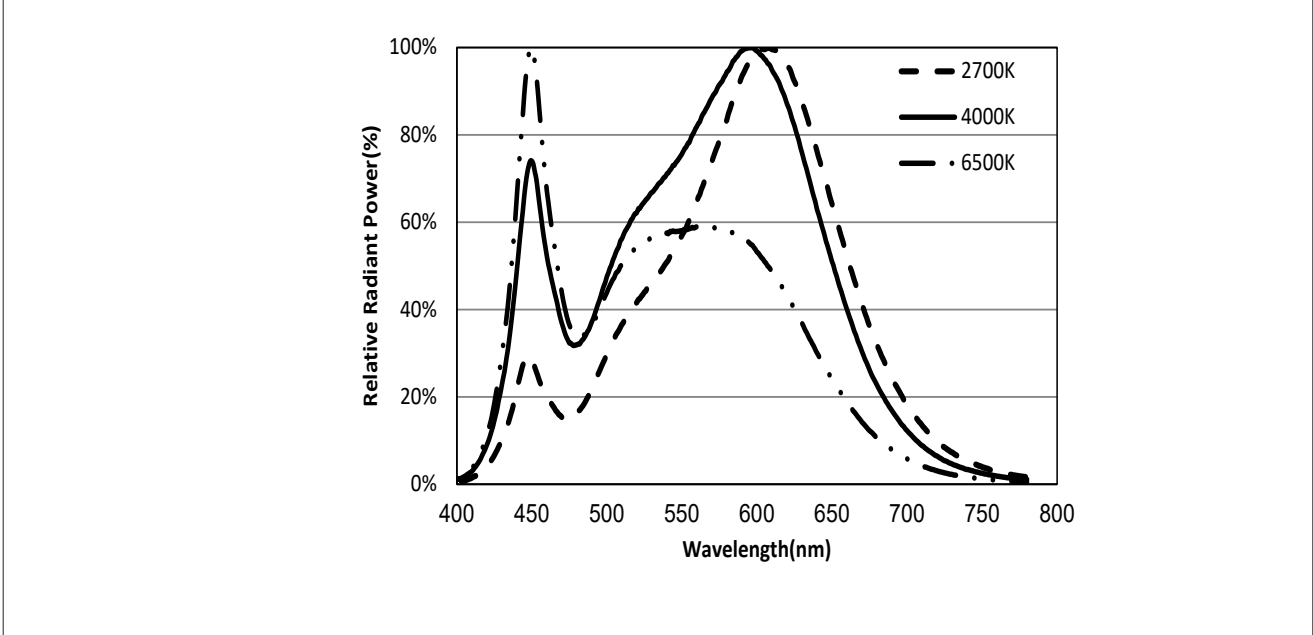

Notes for Figure 9:  
1. Color spectra measured at nominal current for Tsp = 25°C  
2. Color spectra shown for 80 CRI products.

# Mechanical Dimensions

Figure 10: Drawing for SMD 2835

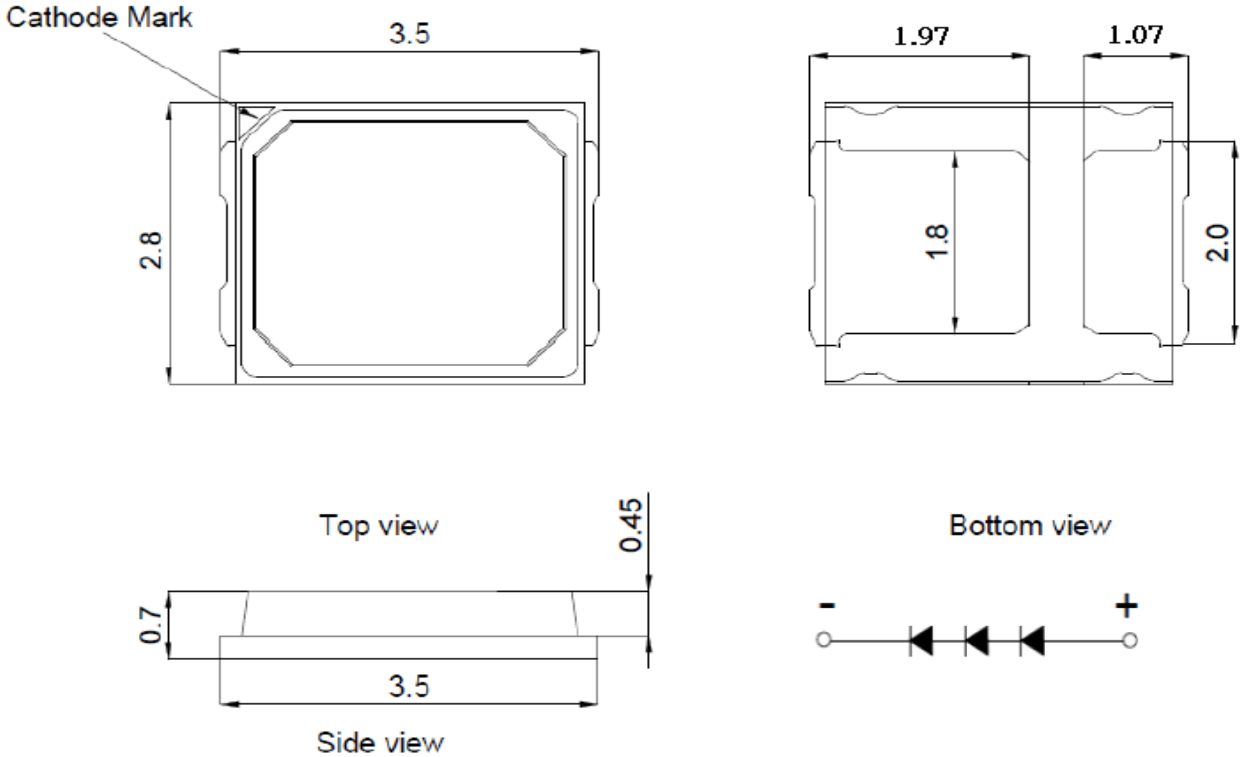

- Notes for Figure 10:
1. Drawings are not to scale.
  2. Drawing dimensions are in millimeters.
  3. Unless otherwise specified, tolerances are  $\pm 0.10\text{mm}$ .

## Recommended PCB Soldering Pad Pattern

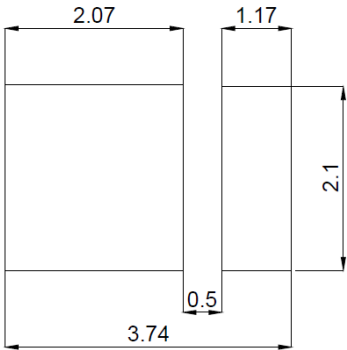

# Reliability

**Table 8: Reliability Test Items and Conditions**

No.	Items	Reference Standard	Test Conditions	Drive Current	Test Duration	Units Failed/Tested
1	Moisture/Reflow Sensitivity	J-STD-020E	$T_{\text{slid}} = 260^{\circ}\text{C}$ , 10sec. Precondition: $60^{\circ}\text{C}$ , 60%RH, 168hr	-	3 reflows	0/20
2	Low Temperature Storage	JESD22-A119	$T_{\text{a}} = -40^{\circ}\text{C}$	-	1000 hours	0/20
3	High Temperature Storage	JESD22-A103D	$T_{\text{a}} = 105^{\circ}\text{C}$	-	1000 hours	0/20
4	Low Temperature Operating Life	JESD22-A108D	$T_{\text{a}} = -40^{\circ}\text{C}$	100mA	1000 hours	0/20
5	Temperature Humidity Operating Life	JESD22-A101C	$T_{\text{sp}} = 85^{\circ}\text{C}$ , RH=85%	100mA	1000 hours	0/20
6	High Temperature Operating Life	JESD22-A108D	$T_{\text{sp}} = 105^{\circ}\text{C}$	120mA	1000 hours	0/20
7	Power switching	IEC62717:2014	$T_{\text{sp}} = 105^{\circ}\text{C}$ 30 sec on, 30 sec off	120mA	30000 cycles	0/20
8	Thermal Shock	JESD22-A106B	$T_{\text{a}} = -40^{\circ}\text{C} \sim 100^{\circ}\text{C}$ ; Dwell: 15min; Transfer: 10sec	-	200 cycles	0/20
9	Temperature Cycle	JESD22-A104E	$T_{\text{a}} = -40^{\circ}\text{C} \sim 100^{\circ}\text{C}$ ; Dwell at extreme temperature: 15min; Ramp rate < $105^{\circ}\text{C}/\text{min}$	-	200 cycles	0/20
10	Electrostatic Discharge	JS-001-2012	HBM, 2kV, 15k $\Omega$ , 100pF. Alternately positive or negative	-	-	0/20

## Passing Criteria

Item	Symbol	Test Condition	Passing Criteria
Forward Voltage	Vf	100mA	$\Delta V_f < 10\%$
Luminous Flux	Fv	100mA	$\Delta F_v < 30\%$
Chromaticity Coordinates	(x, y)	100mA	$\Delta u'v' < 0.007$

Notes for Table 8:

- Measurements are performed after allowing the LEDs to return to room temperature
- $T_{\text{slid}}$ : reflow soldering temperature;  $T_{\text{a}}$ : ambient temperature

# Reflow Characteristics

Figure 11 : Reflow Profile

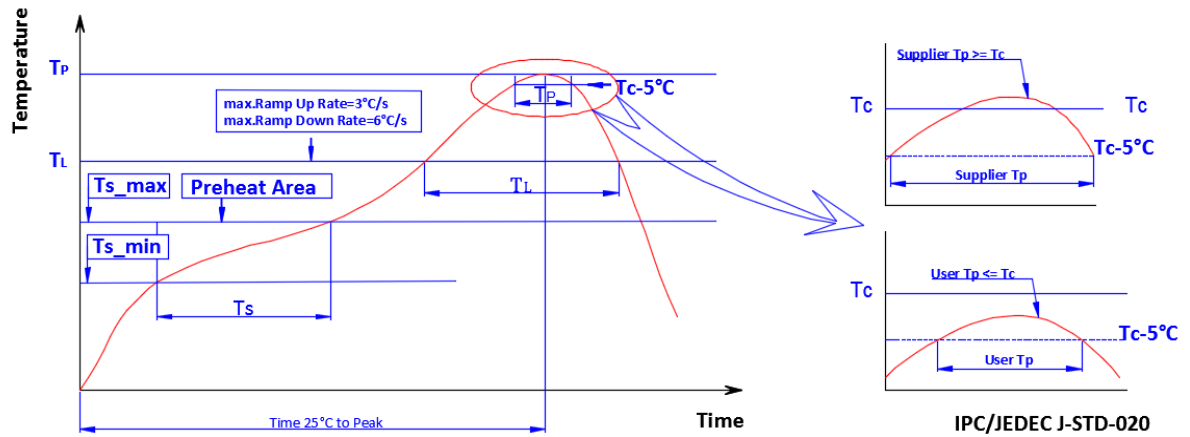

Profile Feature	Lead Free Assembly
Temperature Min. ( $T_{s\_min}$ )	160°C
Temperature Max. ( $T_{s\_max}$ )	205°C
Time (ts) from $T_{s\_min}$ to $T_{s\_max}$	60-150 seconds
Ramp-Up Rate (TL to $T_p$ )	3 °C/second
Liquidus Temperature (TL)	220 °C
Time (TL) Maintained Above TL	60-150 seconds
Peak Temp( $T_p$ )	260 °C max.
Time ( $T_p$ ) Within 5 °C of the Specified Classification Temperature ( $T_c$ )	25 seconds max.
Ramp-Down Rate ( $T_p$ to TL)	5 °C/second max.
Time 25 °C to Peak Temperature	10 minutes max.

# Packaging

**Figure 12: Emitter Reel Drawings**

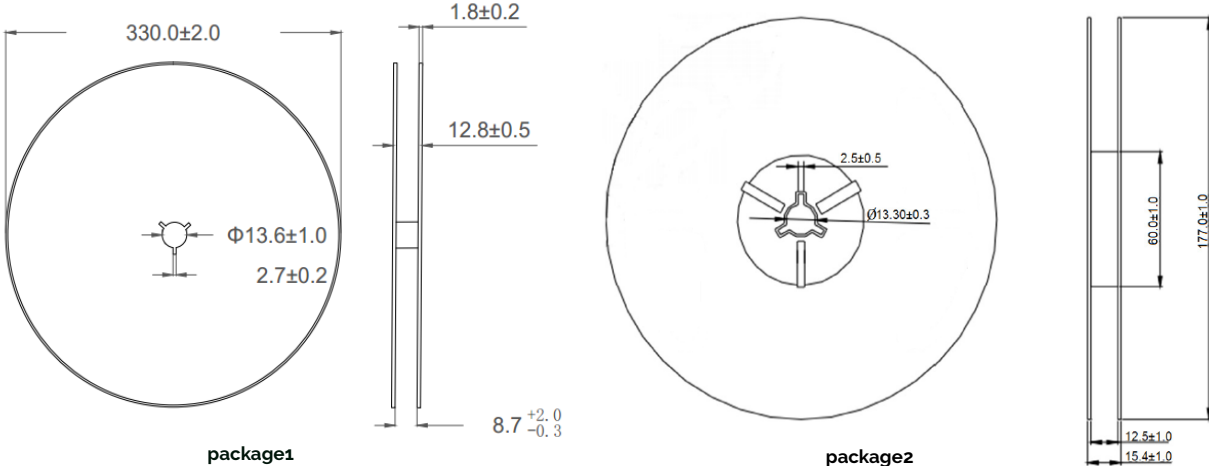

Note for Figure 12:  
 1. Drawings are not to scale. Drawing dimensions are in millimeters.

**Figure 13: Emitter Tape Drawings**

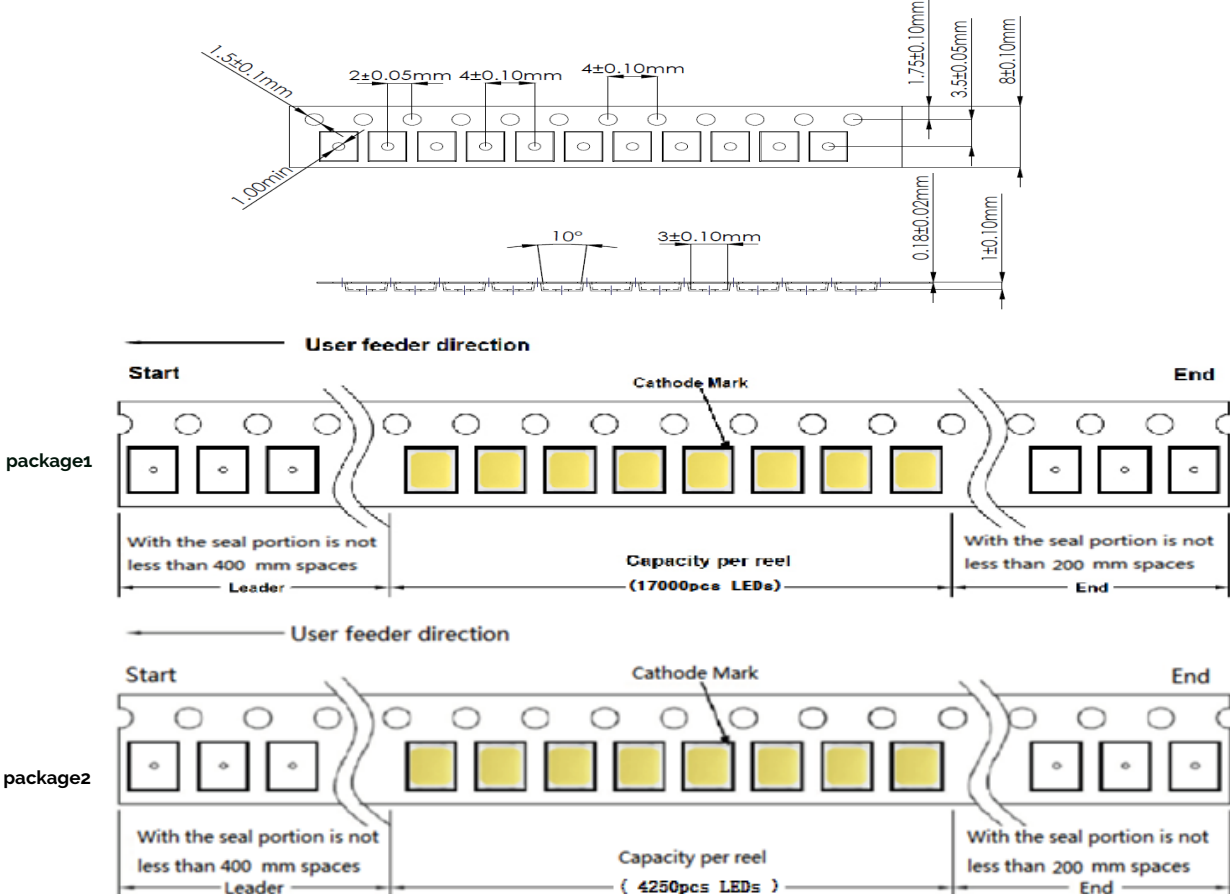

Note for Figure 13:  
 1. Drawings are not to scale. Drawing dimensions are in millimeters.

# Packaging

Figure 14: Emitter Reel Packaging Drawings

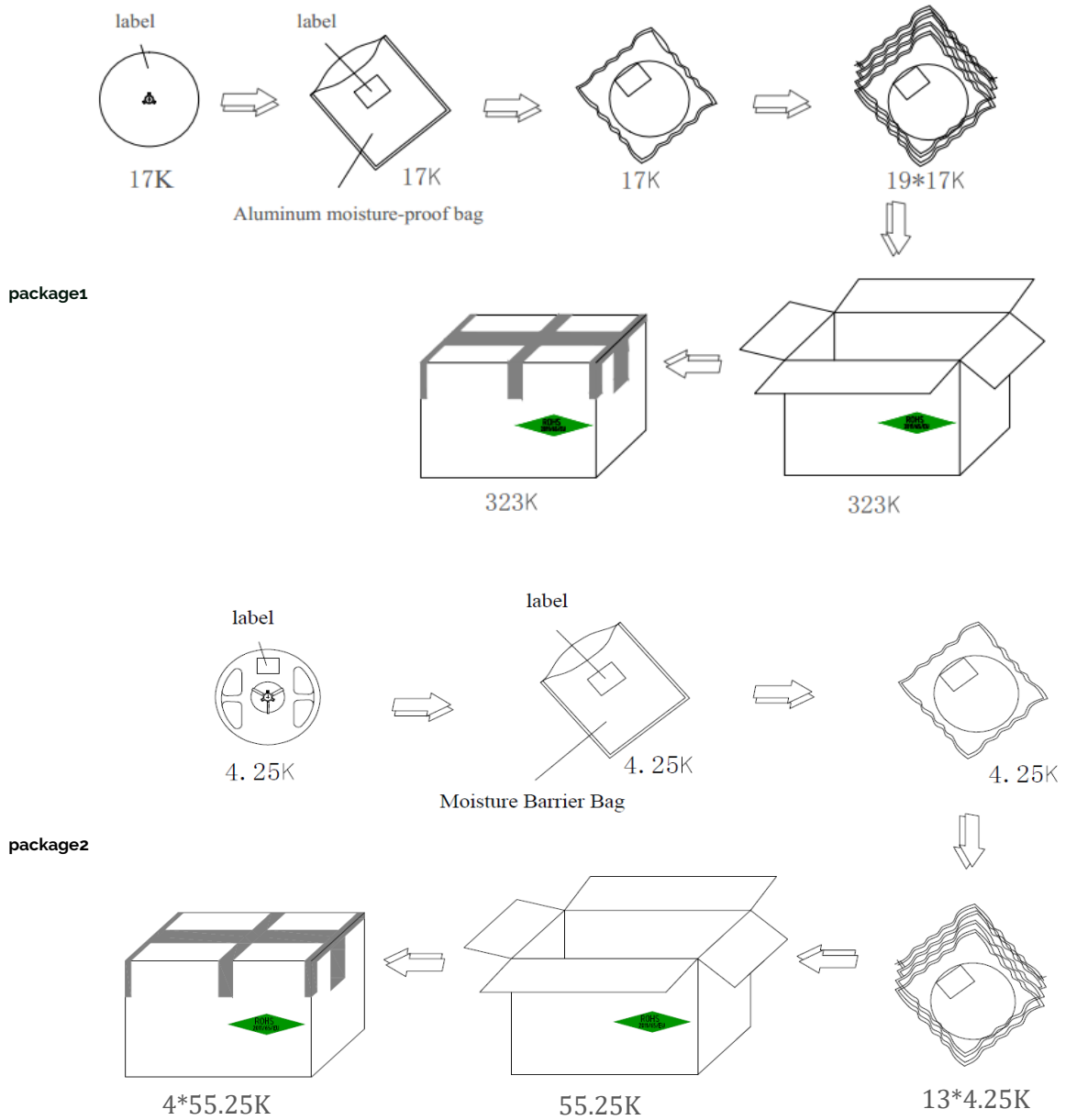

Note for Figure 14:  
1. Drawings are not to scale.

# Design Resources

Please contact your Bridgelux sales representative for assistance.

## Precautions

### **CAUTION: CHEMICAL EXPOSURE HAZARD**

Exposure to some chemicals commonly used in luminaire manufacturing and assembly can cause damage to the LED emitter. Please consult Bridgelux Application Note AN51 for additional information.

### **CAUTION: EYE SAFETY**

Eye safety classification for the use of Bridgelux SMD LED emitter is in accordance with IEC specification EN62471: Photobiological Safety of Lamps and Lamp Systems. SMD LED emitters are classified as Risk Group 1 when operated at or below the maximum drive current. Please use appropriate precautions. It is important that employees working with LEDs are trained to use them safely.

### **CAUTION: RISK OF BURN**

Do not touch the SMD LED emitter during operation. Allow the emitter to cool for a sufficient period of time before handling. The SMD LED emitter may reach elevated temperatures such that could burn skin when touched.

## CAUTION

### **CONTACT WITH LIGHT EMITTING SURFACE (LES)**

Avoid any contact with the LES. Do not touch the LES of the emitter or apply stress to the LES (yellow phosphor resin area). Contact may cause damage to the emitter

Optics and reflectors must not be mounted in contact with the LES (yellow phosphor resin area).

## Disclaimers

### **MINOR PRODUCT CHANGE POLICY**

The rigorous qualification testing on products offered by Bridgelux provides performance assurance. Slight cosmetic changes that do not affect form, fit, or function may occur as Bridgelux continues product optimization.

### **STANDARD TEST CONDITIONS**

Unless otherwise stated, LED emitter testing is performed at the nominal drive current.

# About Bridgelux: Bridging Light and Life™

At Bridgelux, we help companies, industries and people experience the power and possibility of light. Since 2002, we've designed LED solutions that are high performing, energy efficient, cost effective and easy to integrate. Our focus is on light's impact on human behavior, delivering products that create better environments, experiences and returns—both experiential and financial. And our patented technology drives new platforms for commercial and industrial luminaires.

**For more information about the company, please visit**  
**bridgelux.com**  
**twitter.com/Bridgelux**  
**facebook.com/Bridgelux**  
**youtube.com/user/Bridgelux**  
**WeChat ID: BridgeluxInChina**  
**[https://www.linkedin.com/company/bridgelux-inc-\\_2](https://www.linkedin.com/company/bridgelux-inc-_2)**



46410 Fremont Boulevard  
Fremont, CA 94538 USA  
Tel (925) 583-8400  
Fax (925) 583-8401  
**[www.bridgelux.com](http://www.bridgelux.com)**

© 2024 Bridgelux, Inc. All rights reserved 2024. Product specifications are subject to change without notice. Bridgelux and the Bridgelux stylized logo design are registered trademarks of Bridgelux, Inc. All other trademarks are the property of their respective owners.