

Bridgelux® SMD 2835 0.5W 3V

Product Data Sheet DS242-3

Introduction

SMD 2835



Features

- Industry-standard 2835 footprint
- Hot-color targeting ensures that color is within the ANSI bin at the typical application conditions of 85°C
- RoHS compliant and lead free
- Multiple CCT configurations for a wide range of lighting applications

Benefits

- Lower operating and manufacturing cost
- Ease of design and rapid go-to-market
- Uniform, consistent white light
- Reliable and constant white point
- Compliant with environmental standards
- Design flexibility

Contents

Product Feature Map	2
Product Nomenclature	2
Product Selection Guide	3
Electrical Characteristics	5
Absolute Maximum Ratings	6
Product Bin Definitions	7
Performance Curves	12
Typical Radiation Pattern	15
Typical Color Spectrum	16
Mechanical Dimensions	17
Reliability	18
Reflow Characteristics	19
Packaging	20
Design Resources	22
Precautions	22
Disclaimers	22
About Bridgelux	23

Product Selection Guide

The following product configurations are available:

Table 1: Selection Guide, Pulsed Measurement Data at 150mA ($T_j = T_{sp} = 25^\circ\text{C}$)

Part Number ^{1,6}	Nominal CCT ² (K)	CRI ^{3,5}	Nominal Drive Current (mA)	Forward Voltage ^{4,5} (V)			Typical Pulsed Flux (lm) ^{4,5}	Typical Power (W)	Typical Efficacy (lm/W)
				Min	Typical	Max			
BXEN-20G-11M-3C3-00-0-0	2000	85	150	2.9	3.1	3.3	50	0.5	107
BXEN-25G-11M-3C3-00-0-0	2500	90	150	2.9	3.1	3.3	55	0.5	118
BXEN-27G-11M-3C3-00-0-0	2700	90	150	2.9	3.1	3.3	59	0.5	127
BXEN-28G-11M-3C3-00-0-0	2800	90	150	2.9	3.1	3.3	59	0.5	127
BXEN-30G-11M-3C3-00-0-0	3000	90	150	2.9	3.1	3.3	60	0.5	129
BXEN-32G-11M-3C3-00-0-0	3200	90	150	2.9	3.1	3.3	60	0.5	129
BXEN-35G-11M-3C3-00-0-0	3500	90	150	2.9	3.1	3.3	60	0.5	129
BXEN-40G-11M-3C3-00-0-0	4000	90	150	2.9	3.1	3.3	63	0.5	135
BXEN-47G-11M-3C3-00-0-0	4700	90	150	2.9	3.1	3.3	63	0.5	135
BXEN-50G-11M-3C3-00-0-0	5000	90	150	2.9	3.1	3.3	63	0.5	135
BXEN-52G-11M-3C3-00-0-0	5200	90	150	2.9	3.1	3.3	63	0.5	135
BXEN-54G-11M-3C3-00-0-0	5400	90	150	2.9	3.1	3.3	63	0.5	135
BXEN-57G-11M-3C3-00-0-0	5700	90	150	2.9	3.1	3.3	63	0.5	135
BXEN-59G-11M-3C3-00-0-0	5900	90	150	2.9	3.1	3.3	63	0.5	135
BXEN-62G-11M-3C3-00-0-0	6200	90	150	2.9	3.1	3.3	63	0.5	135
BXEN-65G-11M-3C3-00-0-0	6500	90	150	2.9	3.1	3.3	63	0.5	135
BXEN-71G-11M-3C3-00-0-0	7100	90	150	2.9	3.1	3.3	63	0.5	135

Table 2: Selection Guide, Pulsed Test Performance ($T_{sp} = 85^\circ\text{C}$)^{7,8}

Part Number ^{1,6}	Nominal CCT ² (K)	CRI ^{3,5}	Nominal Drive Current (mA)	Forward Voltage ⁵ (V)			Typical Pulsed Flux (lm) ⁵	Typical Power (W)	Typical Efficacy (lm/W)
				Min	Typical	Max			
BXEN-20G-11M-3C3-00-0-0	2000	85	150	2.8	3.0	3.2	45	0.4	100
BXEN-25G-11M-3C3-00-0-0	2500	90	150	2.8	3.0	3.2	49	0.4	105
BXEN-27G-11M-3C3-00-0-0	2700	90	150	2.8	3.0	3.2	53	0.4	118
BXEN-28G-11M-3C3-00-0-0	2800	90	150	2.8	3.0	3.2	53	0.4	118
BXEN-30G-11M-3C3-00-0-0	3000	90	150	2.8	3.0	3.2	54	0.4	120
BXEN-32G-11M-3C3-00-0-0	3200	90	150	2.8	3.0	3.2	54	0.4	120
BXEN-35G-11M-3C3-00-0-0	3500	90	150	2.8	3.0	3.2	54	0.4	120
BXEN-40G-11M-3C3-00-0-0	4000	90	150	2.8	3.0	3.2	57	0.4	127
BXEN-47G-11M-3C3-00-0-0	4700	90	150	2.8	3.0	3.2	57	0.4	127
BXEN-50G-11M-3C3-00-0-0	5000	90	150	2.8	3.0	3.2	57	0.4	127
BXEN-52G-11M-3C3-00-0-0	5200	90	150	2.8	3.0	3.2	57	0.4	127
BXEN-54G-11M-3C3-00-0-0	5400	90	150	2.8	3.0	3.2	57	0.4	127
BXEN-57G-11M-3C3-00-0-0	5700	90	150	2.8	3.0	3.2	57	0.4	127
BXEN-59G-11M-3C3-00-0-0	5900	90	150	2.8	3.0	3.2	57	0.4	127
BXEN-62G-11M-3C3-00-0-0	6200	90	150	2.8	3.0	3.2	57	0.4	127
BXEN-65G-11M-3C3-00-0-0	6500	90	150	2.8	3.0	3.2	57	0.4	127
BXEN-71G-11M-3C3-00-0-0	7100	90	150	2.8	3.0	3.2	57	0.4	127

Product Selection Guide

Notes for Tables 1 & 2:

1. The last 6 characters (including hyphens '-') refer to flux bins, forward voltage bins, and color bin options, respectively. "00-0-0" denotes the full distribution of flux, forward voltage, and color bin.
Example: BXEN-30G-11M-3C3-00-0-0 refers to the full distribution of flux, forward voltage, and color within a 3000K 7-step ANSI standard chromaticity region with a minimum of 90 CRI, 2000K minimum of 85 CRI, .1x1 die configuration, mid power, 3.1V typical forward voltage, Tsp = 25°C.
2. Product CCT is not targeted at Tsp = 85°C. Nominal CCT as defined by ANSI C78.377-2011.
3. Listed CRIs are minimum values.
4. Products tested under pulsed condition (10ms pulse width) at nominal drive current.
5. Bridgelux maintains a ±7.5% tolerance on luminous flux measurements, ±0.1V tolerance on forward voltage measurements, and ±2 tolerance on CRI measurements for the SMD 2835.
6. Refer to Table 5 and Table 6 for Bridgelux SMD 2835 Luminous Flux Binning and Forward Voltage Binning information.
7. Typical pulsed test performance values are provided as reference only and are not a guarantee of performance.
8. Typical performance is estimated based on operation under pulsed current with LED emitter mounted onto a heat sink with thermal interface material and the solder point temperature maintained at 25°C. Based on Bridgelux test setup, values may vary depending on the thermal design of the luminaire and the exposed environment to which the product is subjected.

Electrical Characteristics

Table 3: Electrical Characteristics

Part Number	Drive Current (mA)	Forward Voltage (V) ^{1,2}			Typical Temperature Coefficient of Forward Voltage $\Delta V_f / \Delta T$ (mV/°C)	Typical Thermal Resistance Junction to Solder Point ³ R_{j-sp} (°C/W)
		Minimum	Typical	Maximum		
BXEN-XXG-11M-3C3-00-0-0	150	2.9	3.1	3.3	-1.35	24

Notes for Table 3:

1. Bridgelux maintains a tolerance of $\pm 0.1V$ on forward voltage measurements. Voltage minimum and maximum values at the nominal drive current are guaranteed by 100% test.
2. Products tested under pulsed condition (10ms pulse width) at nominal drive current where $T_{sp} = 25^\circ C$.
3. Thermal resistance value was calculated using total electrical input power; optical power was not subtracted from input power.

Absolute Maximum Ratings

Table 4: Maximum Ratings

Parameter	Maximum Rating
LED Junction Temperature (T_j)	125°C
Storage Temperature	-40°C to +105°C
Operating Solder Point Temperature (T_{sp})	-40°C to +105°C
Soldering Temperature	260°C or lower for a maximum of 10 seconds
Maximum Drive Current	240mA
Maximum Peak Pulsed Forward Current ¹	360mA
Maximum Reverse Voltage ²	-
Moisture Sensitivity Rating	MSL 3
Electrostatic Discharge	2kV HBM. JEDEC-JS-001-HBM and JEDEC-JS-001-2012

Notes for Table 4:

1. Bridgelux recommends a maximum duty cycle of 10% and pulse width of 10 ms when operating LED SMD at maximum peak pulsed current specified. Maximum peak pulsed current indicate values where LED SMD can be driven without catastrophic failures.
2. Light emitting diodes are not designed to be driven in reverse voltage and will not produce light under this condition. no rating is provided.

Product Bin Definitions

Table 5 lists the standard photometric luminous flux bins for Bridgelux SMD 2835 LEDs. Although several bins are listed, product availability in a particular bin varies by production run and by product performance. Not all bins are available in all CCTs.

Table 5: Luminous Flux Bin Definitions at 150mA, $T_{sp}=25^{\circ}\text{C}$

Bin Code	Minimum	Maximum	Unit	Condition
29	45	50	lm	$I_F=150\text{mA}$
2A	50	55		
2B	55	60		
2C	60	65		
2D	65	70		

Note for Table 5:

1. Bridgelux maintains a tolerance of $\pm 7.5\%$ on luminous flux measurements.

Table 6: Forward Voltage Bin Definition at 150mA, $T_{sp}=25^{\circ}\text{C}$

Bin Code	Minimum	Maximum	Unit	Condition
B	2.9	3.0	V	$I_F=150\text{mA}$
C	3.0	3.1		
D	3.1	3.2		
E	3.2	3.3		

Note for Table 6:

1. Bridgelux maintains a tolerance of $\pm 0.1\text{V}$ on forward voltage measurements.

Product Bin Definitions

Table 7: MacAdam Ellipse Color Bin Definitions.

CCT	Color Space	Center Point		Major Axis	Minor Axis	Ellipse Rotation Angle	Color Bin
		X	Y				
2000K ($T_{sp}=25^{\circ}\text{C}$)	3 SDCM	0.5300	0.4158	0.00960	0.00441	51.67	1
	6 SDCM	0.5300	0.4158	0.01920	0.00882	51.67	1/A/B/C/D
2500K ($T_{sp}=25^{\circ}\text{C}$)	3 SDCM	0.4806	0.4237	0.00960	0.00426	53.41	1
	6 SDCM	0.4806	0.4237	0.01920	0.00852	53.41	1/A/B/C/D
2700K	3 SDCM	0.4578	0.4101	0.00810	0.00420	53.70	1
	5 SDCM	0.4578	0.4101	0.01350	0.00700	53.70	1/A/B/C/D
2800K ($T_{sp}=25^{\circ}\text{C}$)	3 SDCM	0.4559	0.4165	0.00810	0.00420	53.70	1
	6 SDCM	0.4559	0.4165	0.0162	0.0084	53.70	1/A/B/C/D
3000K	3 SDCM	0.4338	0.4030	0.00834	0.00408	53.22	1
	5 SDCM	0.4338	0.4030	0.01390	0.00680	53.22	1/A/B/C/D
3200K ($T_{sp}=25^{\circ}\text{C}$)	3 SDCM	0.4310	0.4101	0.00834	0.00408	53.22	1
	6 SDCM	0.4310	0.4101	0.01668	0.00816	53.22	1/A/B/C/D
3500K	3 SDCM	0.4073	0.3917	0.00927	0.00414	54.00	1
	5 SDCM	0.4073	0.3917	0.01545	0.00690	54.00	1/A/B/C/D
4000K	3 SDCM	0.3818	0.3797	0.00939	0.00402	53.72	1
	5 SDCM	0.3818	0.3797	0.01565	0.00670	53.72	1/A/B/C/D
4700K ($T_{sp}=25^{\circ}\text{C}$)	3 SDCM	0.3536	0.3640	0.00822	0.00354	59.62	1
	6 SDCM	0.3536	0.3640	0.01644	0.00708	59.62	1/A/B/C/D
5000K	3 SDCM	0.3447	0.3553	0.00822	0.00354	59.62	1
	5 SDCM	0.3447	0.3553	0.01370	0.00590	59.62	1/A/B/C/D
5200K ($T_{sp}=25^{\circ}\text{C}$)	3 SDCM	0.3441	0.3664	0.00822	0.00354	59.62	1
	6 SDCM	0.3441	0.3664	0.01644	0.00708	59.62	1/A/B/C/D
5400K ($T_{sp}=25^{\circ}\text{C}$)	3 SDCM	0.3360	0.3485	0.00746	0.00320	59.09	1
	6 SDCM	0.3360	0.3485	0.01492	0.0064	59.09	1/A/B/C/D
5700K	3 SDCM	0.3287	0.3417	0.00746	0.00320	59.09	1
	5 SDCM	0.3287	0.3417	0.01243	0.00533	59.09	1/A/B/C/D
5900K ($T_{sp}=25^{\circ}\text{C}$)	3 SDCM	0.3281	0.3528	0.00746	0.00320	59.09	1
	6 SDCM	0.3281	0.3528	0.01492	0.00640	59.09	1/A/B/C/D
6200K ($T_{sp}=25^{\circ}\text{C}$)	3 SDCM	0.3192	0.3315	0.00669	0.00285	58.57	1
	6 SDCM	0.3192	0.3315	0.01338	0.00570	58.57	1/A/B/C/D
6500K	3 SDCM	0.3123	0.3282	0.00669	0.00285	58.57	1
	5 SDCM	0.3123	0.3282	0.01115	0.00475	58.57	1/A/B/C/D
7100K ($T_{sp}=25^{\circ}\text{C}$)	3 SDCM	0.3014	0.3300	0.00990	0.00336	65.65	1
	6 SDCM	0.3014	0.3300	0.01980	0.00672	65.65	1/A/B/C/D

Product Bin Definitions

Point	2700K		3000K		3500K		4000K		5000K		5700K		6500K		Color Bin
	x	y	x	y	x	y	x	y	x	y	x	y	x	y	
ANSI	0.4813	0.4319	0.4562	0.4260	0.4299	0.4165	0.4006	0.4044	0.3551	0.3760	0.3376	0.3616	0.3205	0.3481	E/F/G/H
	0.4562	0.426	0.4299	0.4165	0.3996	0.4015	0.3736	0.3874	0.3376	0.3616	0.3207	0.3462	0.3028	0.3304	
	0.4373	0.3893	0.4147	0.3814	0.3889	0.3690	0.3670	0.3578	0.3366	0.3369	0.3222	0.3243	0.3068	0.3113	
	0.4593	0.3944	0.4373	0.3893	0.4147	0.3814	0.3898	0.3716	0.3515	0.3487	0.3366	0.3369	0.3221	0.3261	
V-up	0.4687	0.4289	0.4431	0.4213	0.4148	0.4090	0.3871	0.3959	0.3463	0.3687	0.3290	0.3538	0.3115	0.3391	
	0.4618	0.4170	0.4377	0.4101	0.4112	0.3996	0.3847	0.3873	0.3457	0.3617	0.3290	0.3470	0.3124	0.3328	
V-down	0.4483	0.3919	0.4260	0.3854	0.4018	0.3752	0.3784	0.3647	0.3440	0.3427	0.3290	0.3300	0.3144	0.3186	
	0.4542	0.4031	0.4310	0.3960	0.4053	0.3844	0.3807	0.3730	0.3445	0.3495	0.3290	0.3369	0.3135	0.3250	
H-left	0.4468	0.4077	0.4223	0.3990	0.3941	0.3848	0.3702	0.3722	0.3371	0.3490	0.3215	0.3350	0.3048	0.3207	
	0.4524	0.4089	0.4283	0.4013	0.4012	0.3885	0.3755	0.3755	0.3395	0.3509	0.3240	0.3372	0.3081	0.3240	
H-right	0.4703	0.4132	0.4468	0.4077	0.4223	0.3990	0.3950	0.3875	0.3533	0.3620	0.3371	0.3490	0.3213	0.3373	
	0.4632	0.4115	0.4394	0.4052	0.4133	0.3945	0.3880	0.3834	0.3498	0.3592	0.3334	0.3456	0.3165	0.3325	
Center	0.4578	0.4101	0.4338	0.4030	0.4073	0.3917	0.3818	0.3797	0.3447	0.3553	0.3287	0.3417	0.3123	0.3282	

Notes for Table 7:

1. Color binning at $T_{sp} = 85^{\circ}\text{C}$ unless otherwise specified
2. Bridgelux maintains a tolerance of ± 0.007 on x and y color coordinates in the CIE 1931 color space.

Product Bin Definitions

Figure 1: C.I.E. 1931 Chromaticity Diagram (Hot-color Targeted at $T_{sp}=85^{\circ}\text{C}$. 2000K/2500K/2800K/3200K/4700K/5200K/5400K/5900K/6200K/7100K= $T_{sp}=25^{\circ}\text{C}$.)

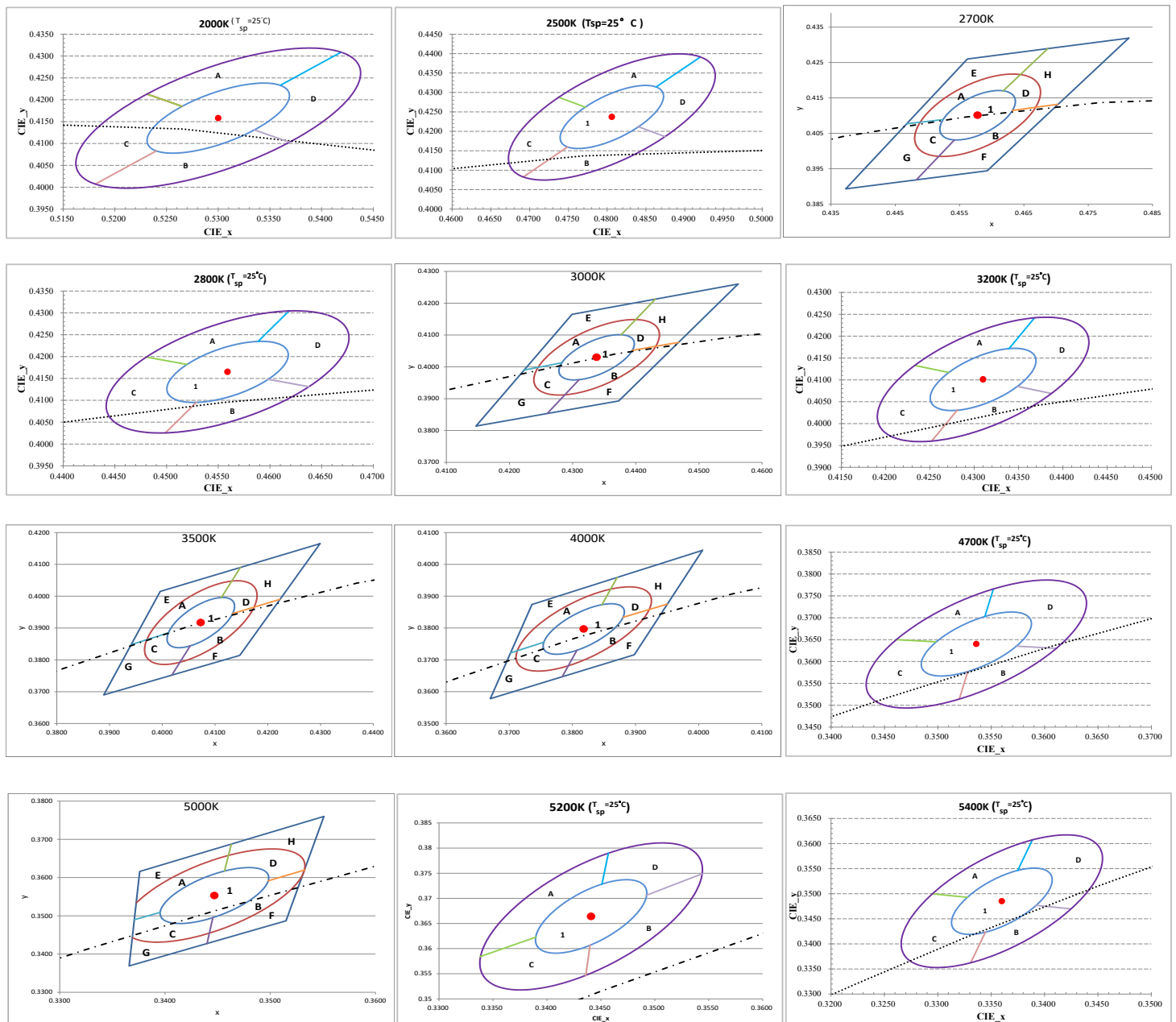

Product Bin Definitions

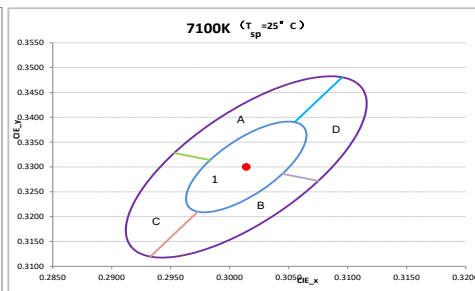
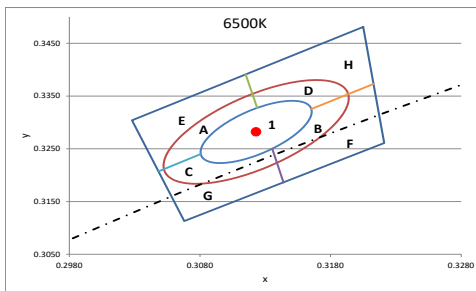
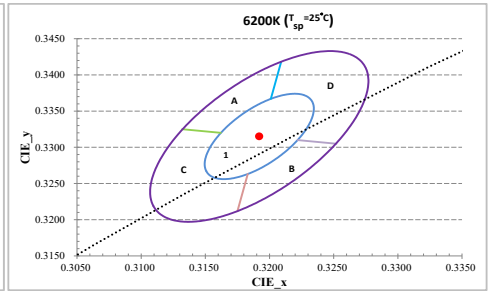
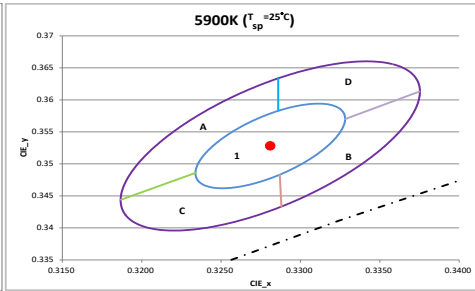
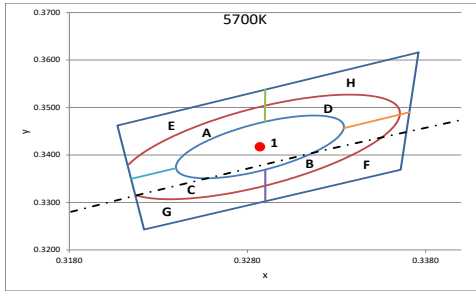

Performance Curves

Figure 2: Drive Current vs. Forward Voltage ($T_{sp}=25^{\circ}\text{C}$)

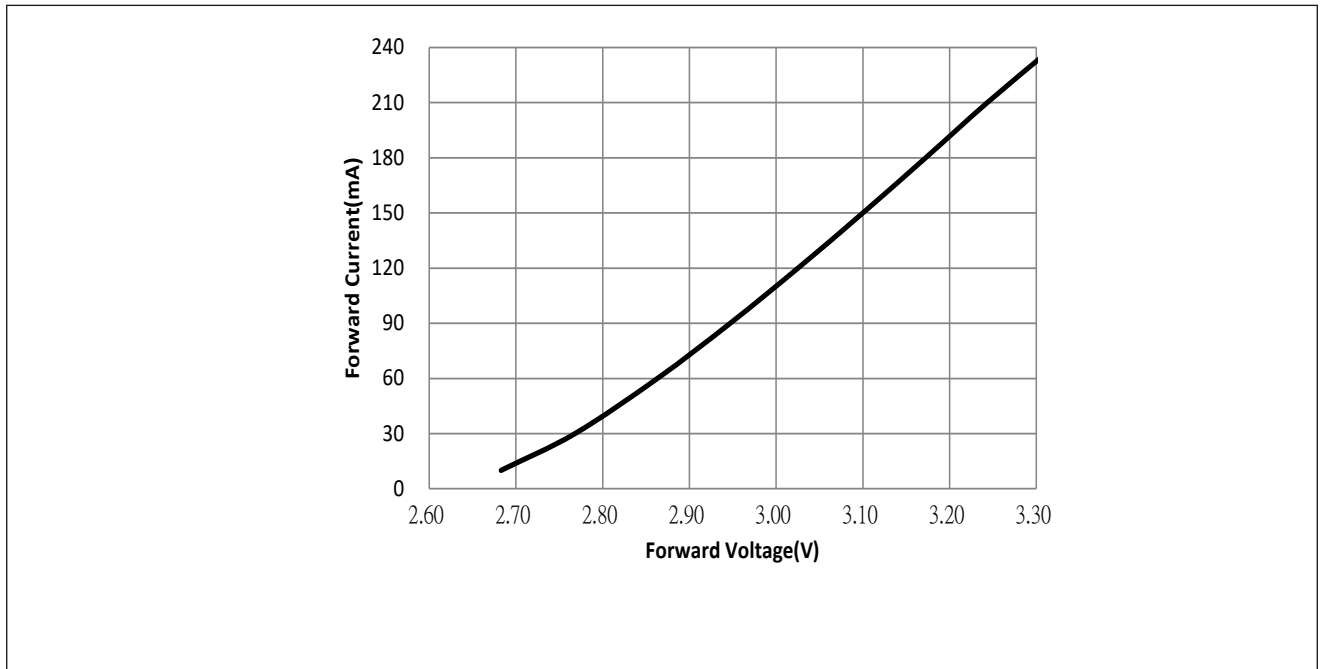
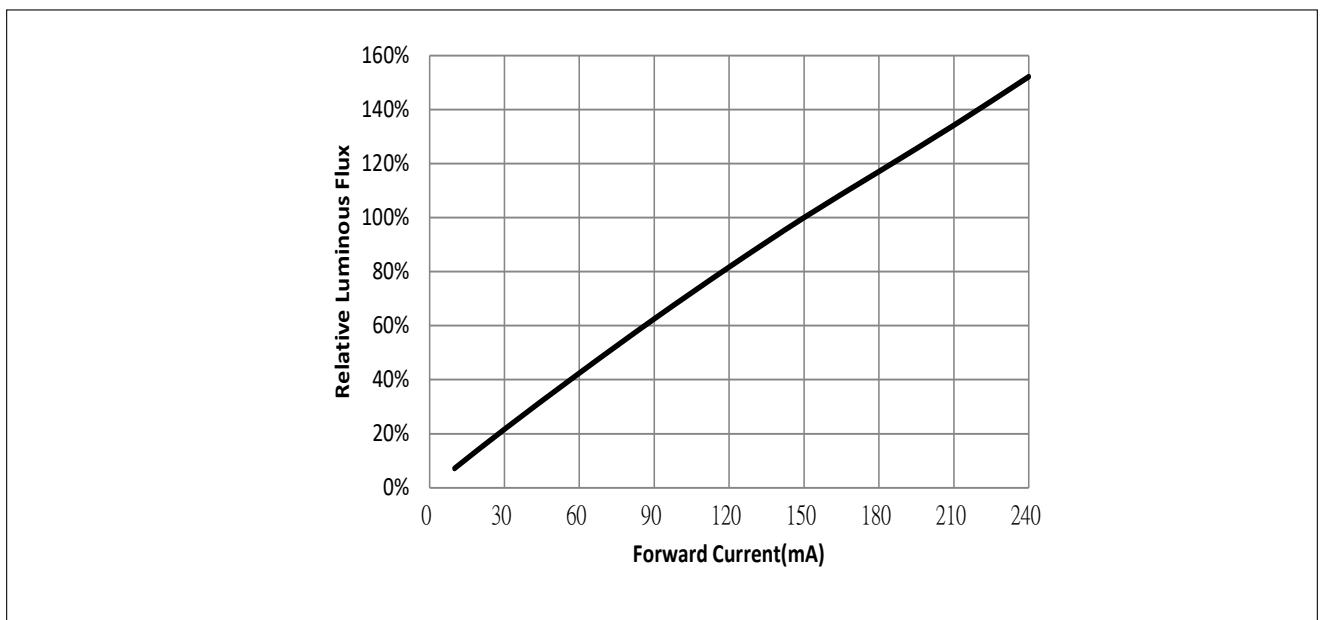

Figure 3: Typical Relative Luminous Flux vs. Forward Current ($T_{sp}=25^{\circ}\text{C}$)



Note for Figure 3:

1. Pulse width modulation (PWM) is recommended for dimming effects.

Performance Curves

Figure 4: Typical Relative Flux vs. Solder Point Temperature

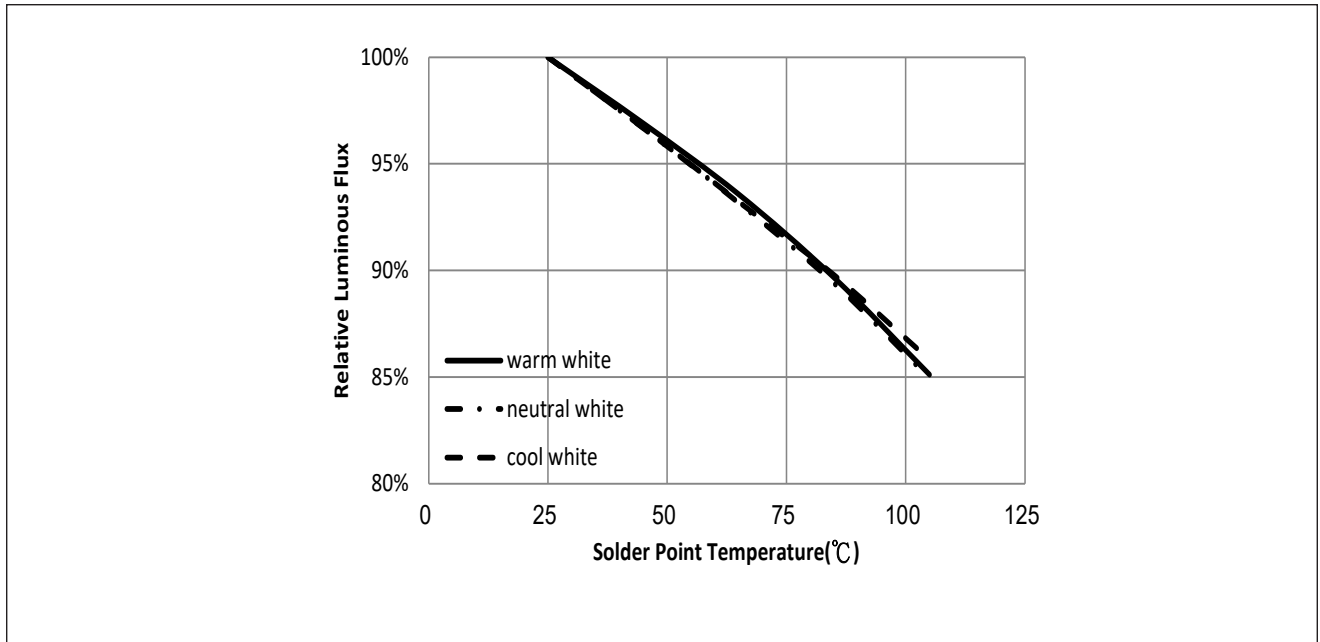
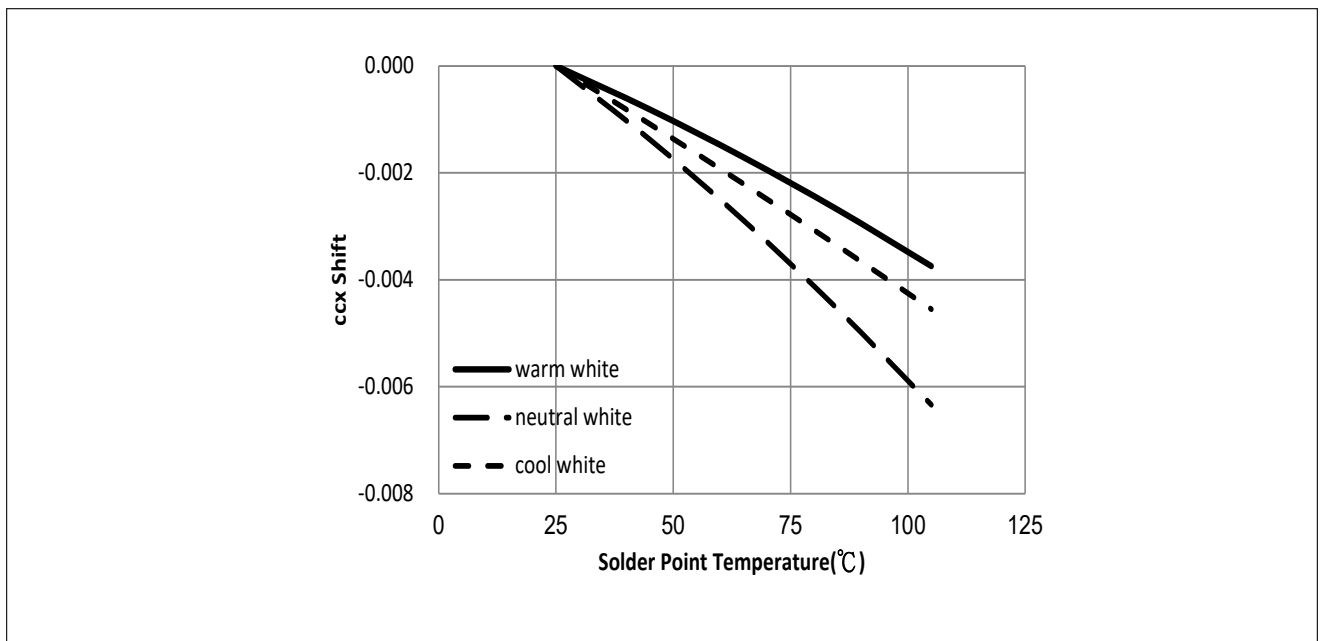

Figure 5: Typical ccx Shift vs. Solder Point Temperature



Notes for Figures 4 & 5:

1. Characteristics shown for warm white based on 3000K and 90 CRI.
2. Characteristics shown for neutral white based on 4000K and 90 CRI.
3. Characteristics shown for cool white based on 5000K and 90 CRI.
4. For other color SKUs, the shift in color will vary. Please contact your Bridgelux Sales Representative for more information.

Performance Curves

Figure 6: Typical ccy Shift vs. Solder Point Temperature

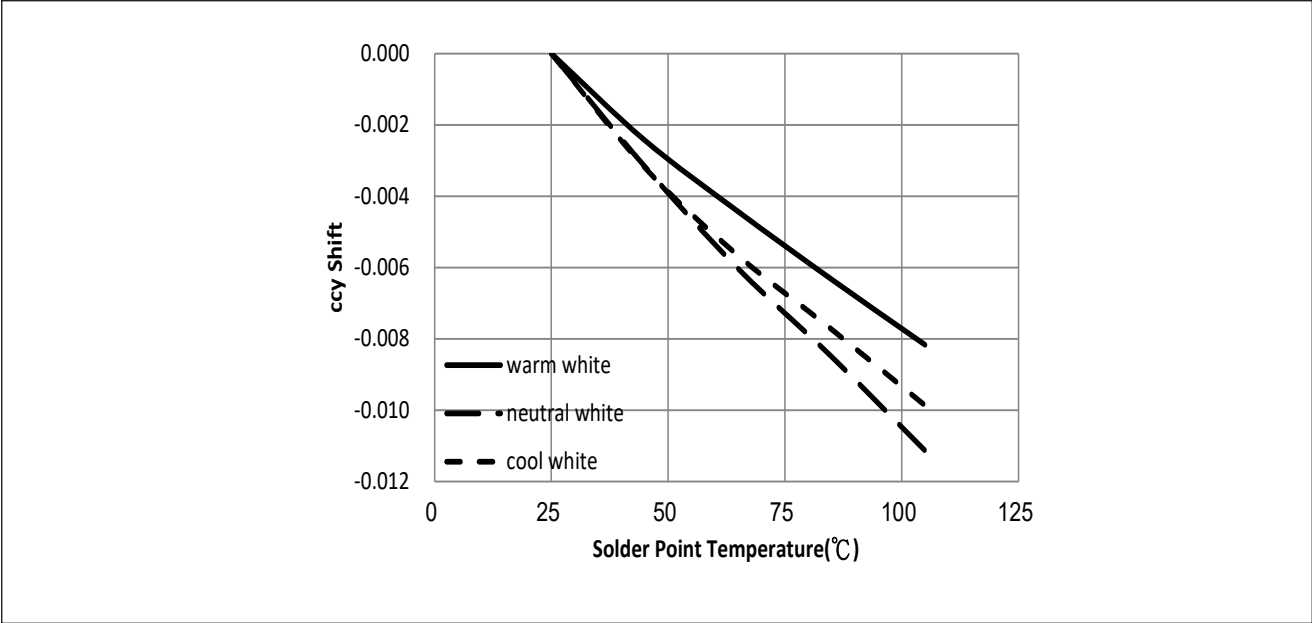

Notes for Figure 6:

- 1. Characteristics shown for warm white based on 3000K and 90 CRI.
- 2. Characteristics shown for neutral white based on 4000K and 90 CRI.
- 3. Characteristics shown for cool white based on 5000K and 90 CRI.
- 4. For other color SKUs, the shift in color will vary. Please contact your Bridgelux Sales Representative for more information.

Typical Radiation Pattern

Figure 7: Typical Spatial Radiation Pattern at 150mA, $T_{sp}=25^{\circ}\text{C}$

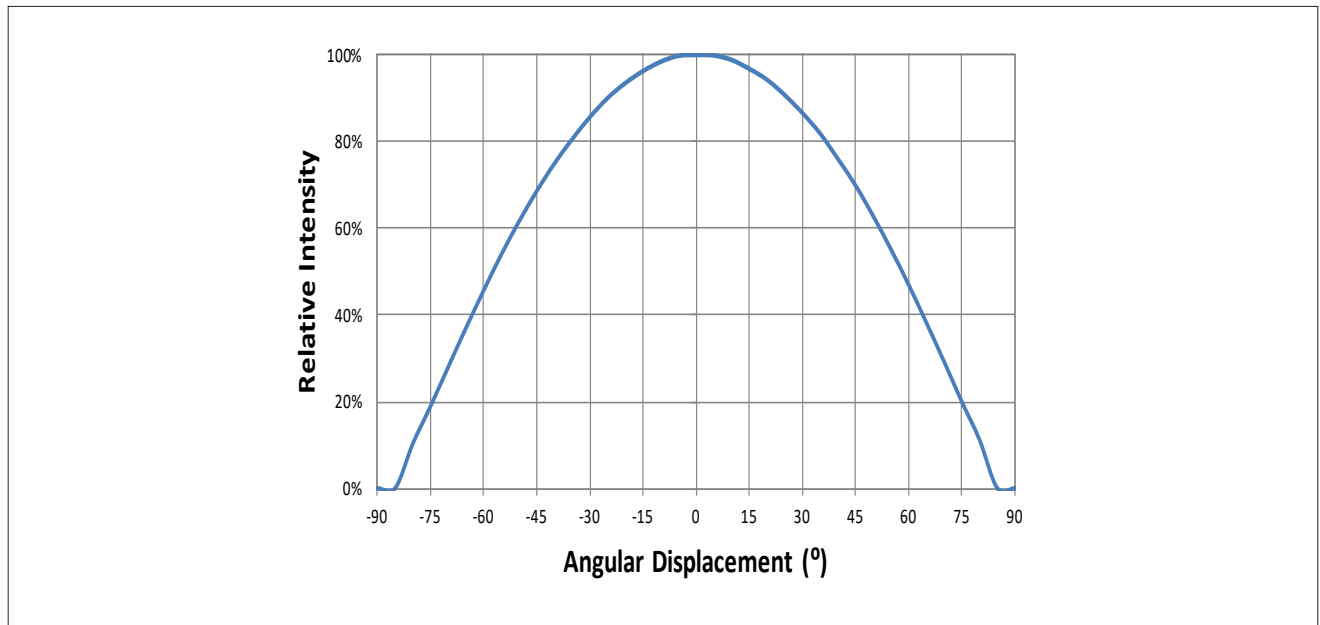

Notes for Figure 7:

1. Typical viewing angle is 120° .
2. The viewing angle is defined as the off axis angle from the centerline where luminous intensity (Iv) is $\frac{1}{2}$ of the peak value.

Figure 8: Typical Polar Radiation Pattern at 150mA, $T_{sp}=25^{\circ}\text{C}$

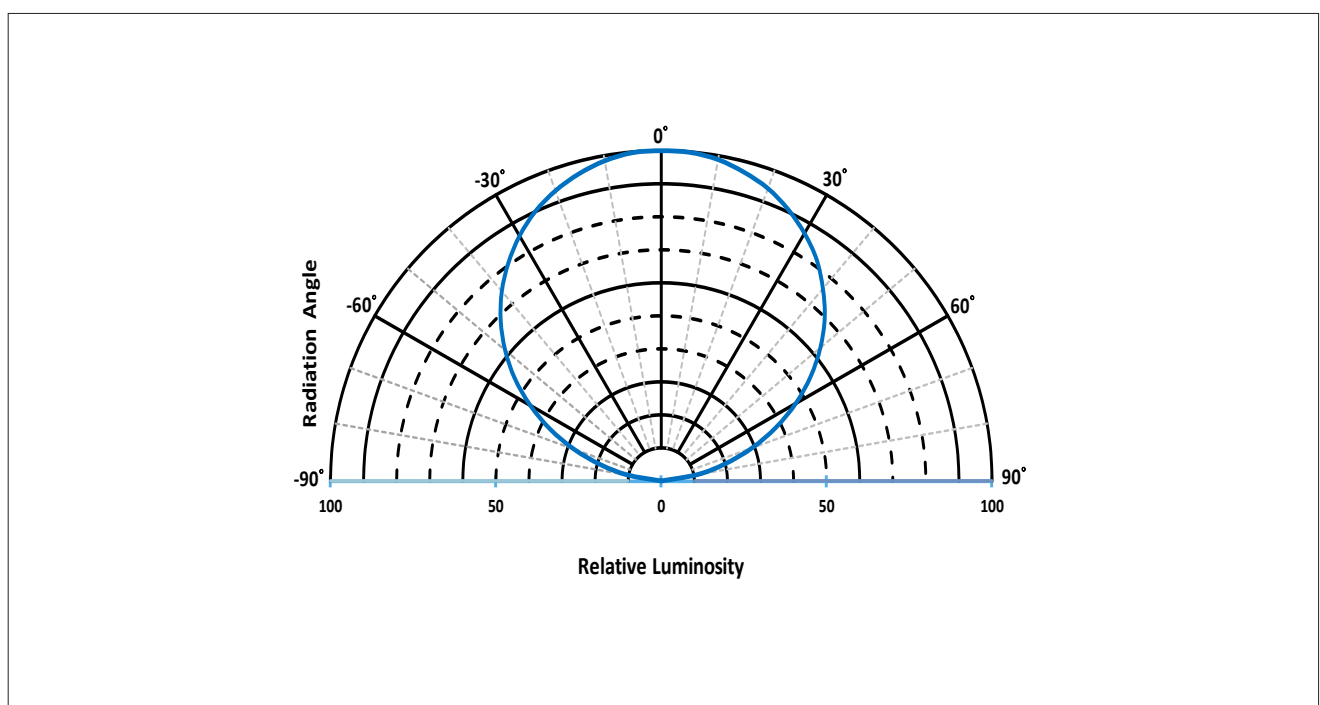

Typical Color Spectrum

Figure 9: Typical Color Spectrum

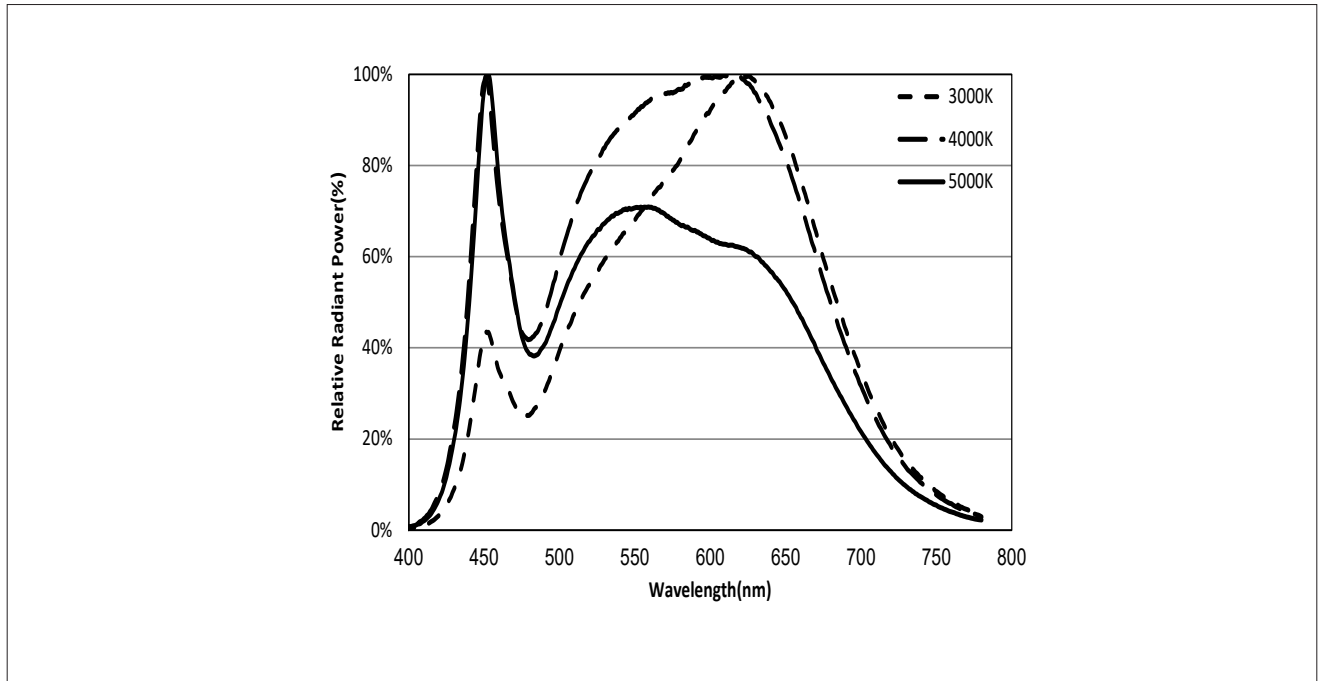

Notes for Figure 9:

1. Color spectra measured at nominal current for $T_{sp} = 25^{\circ}\text{C}$
2. Color spectra shown for 90 CRI products.

Mechanical Dimensions

Figure 10: Drawing for SMD 2835

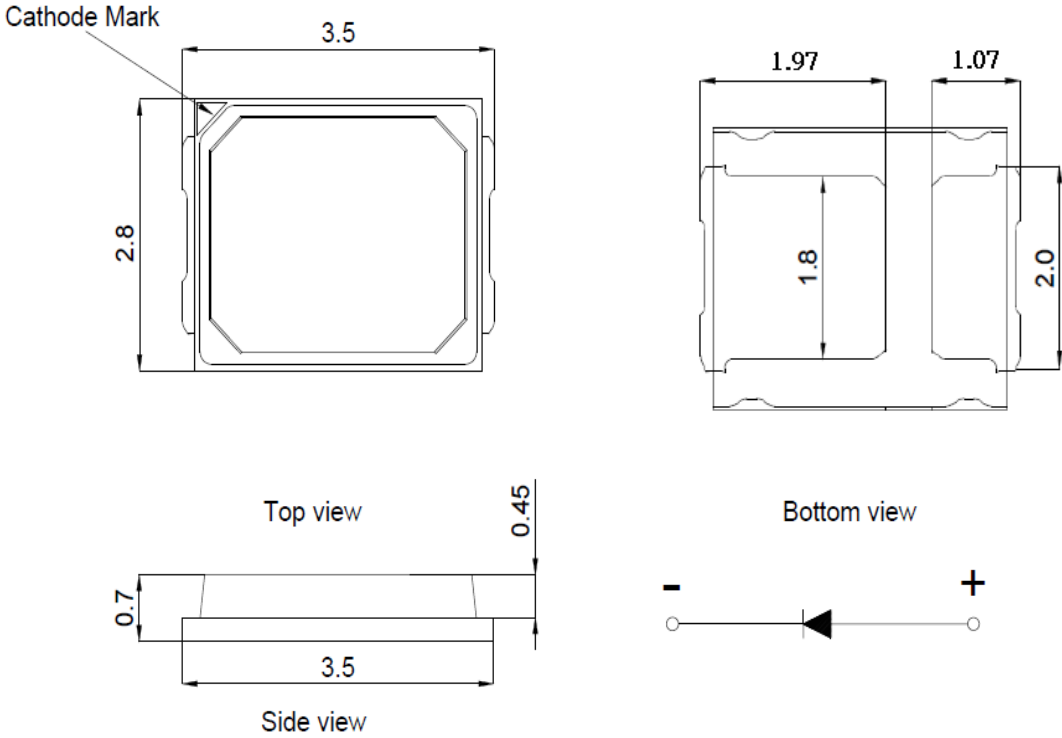

- Notes for Figure 10:
1. Drawings are not to scale.
 2. Drawing dimensions are in millimeters.
 3. Different mould pattern differences may
 4. Unless otherwise specified, tolerances are $\pm 0.10\text{mm}$.

Recommended PCB Soldering Pad Pattern

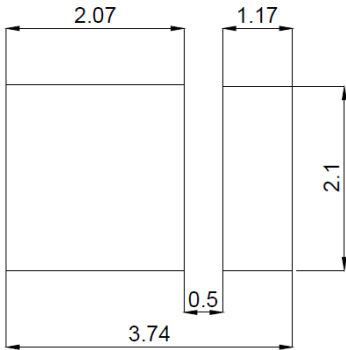

Reliability

Table 8: Reliability Test Items and Conditions

No.	Items	Reference Standard	Test Conditions	Drive Current	Test Duration	Units Failed/Tested
1	Moisture/Reflow Sensitivity	J-STD-020E	$T_{\text{slid}} = 260^{\circ}\text{C}$, 10sec. Precondition: 60°C , 60%RH, 168hr	-	3 reflows	0/20
2	Low Temperature Storage	JESD22-A119	$T_{\text{a}} = -40^{\circ}\text{C}$	-	1000 hours	0/20
3	High Temperature Storage	JESD22-A103D	$T_{\text{a}} = 100^{\circ}\text{C}$	-	1000 hours	0/20
4	Low Temperature Operating Life	JESD22-A108D	$T_{\text{a}} = -40^{\circ}\text{C}$	150mA	1000 hours	0/20
5	Temperature Humidity Operating Life	JESD22-A101C	$T_{\text{sp}} = 85^{\circ}\text{C}$, RH=85%	150mA	1000 hours	0/20
6	High Temperature Operating Life	JESD22-A108D	$T_{\text{sp}} = 85^{\circ}\text{C}$	240mA	1000 hours	0/20
7	Power switching	IEC62717:2014	$T_{\text{sp}} = 85^{\circ}\text{C}$ 30 sec on, 30 sec off	240mA	30000 cycles	0/20
8	Thermal Shock	JESD22-A106B	$T_{\text{a}} = -40^{\circ}\text{C} \sim 100^{\circ}\text{C}$; Dwell : 15min; Transfer: 10sec	-	200 cycles	0/20
9	Temperature Cycle	JESD22-A104E	$T_{\text{a}} = -40^{\circ}\text{C} \sim 100^{\circ}\text{C}$; Dwell at extreme temperature: 15min; Ramp rate < $105^{\circ}\text{C}/\text{min}$	-	200 cycles	0/20
10	Electrostatic Discharge	JS-001-2012	HBM, 2kV, 15k Ω , 100pF. Alternately positive or negative	-	-	0/20

Passing Criteria

Item	Symbol	Test Condition	Passing Criteria
Forward Voltage	Vf	150mA	$\Delta V_f < 10\%$
Luminous Flux	Fv	150mA	$\Delta F_v < 30\%$
Chromaticity Coordinates	(x, y)	150mA	$\Delta u'v' < 0.007$

Notes for Table 8:

- Measurements are performed after allowing the LEDs to return to room temperature
- T_{slid} : reflow soldering temperature; T_{a} : ambient temperature

Reflow Characteristics

Figure 11 : Reflow Profile (Reflow frequency 2 times max)

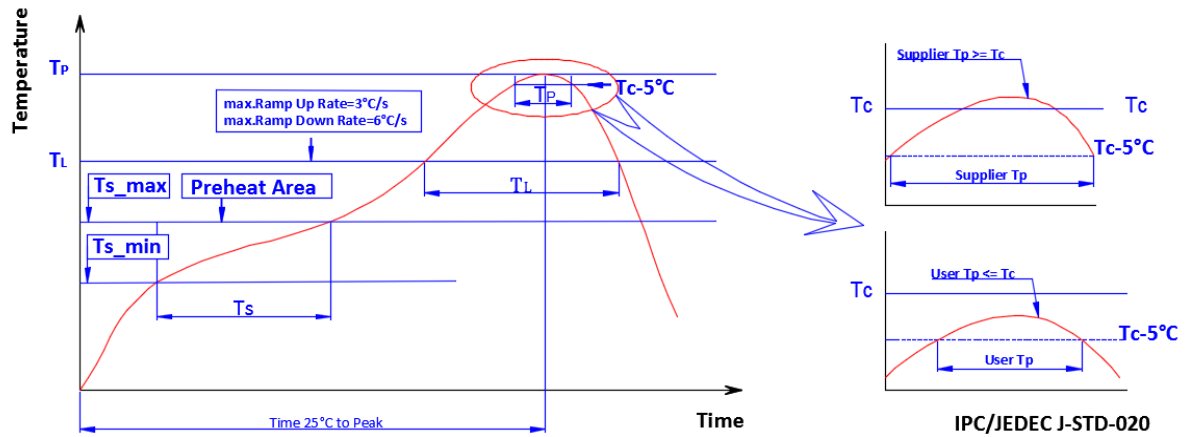

Profile Feature	Lead Free Assembly
Temperature Min. (Ts_min)	160°C
Temperature Max. (Ts_max)	205°C
Time (ts) from Ts_min to Ts_max	60-150 seconds
Ramp-Up Rate (TL to Tp)	3 °C/second
Liquidus Temperature (TL)	220 °C
Time (TL) Maintained Above TL	60-150 seconds
Peak Temp(Tp)	260 °C max 10 sec
Time (Tp) Within 5 °C of the Specified Classification Temperature (Tc)	25 seconds max.
Ramp-Down Rate (Tp to TL)	5 °C/second max.
Time 25 °C to Peak Temperature	10 minutes max.

Packaging

Figure 12: Emitter Reel Drawings

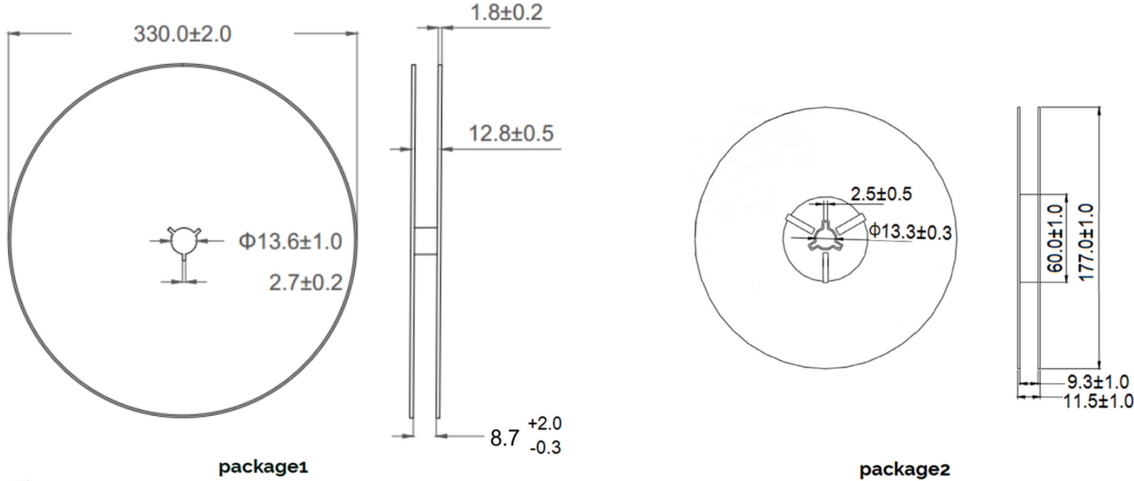

Note for Figure 12:

- 1. Drawings are not to scale. Drawing dimensions are in millimeters.

Figure 13: Emitter Tape Drawings

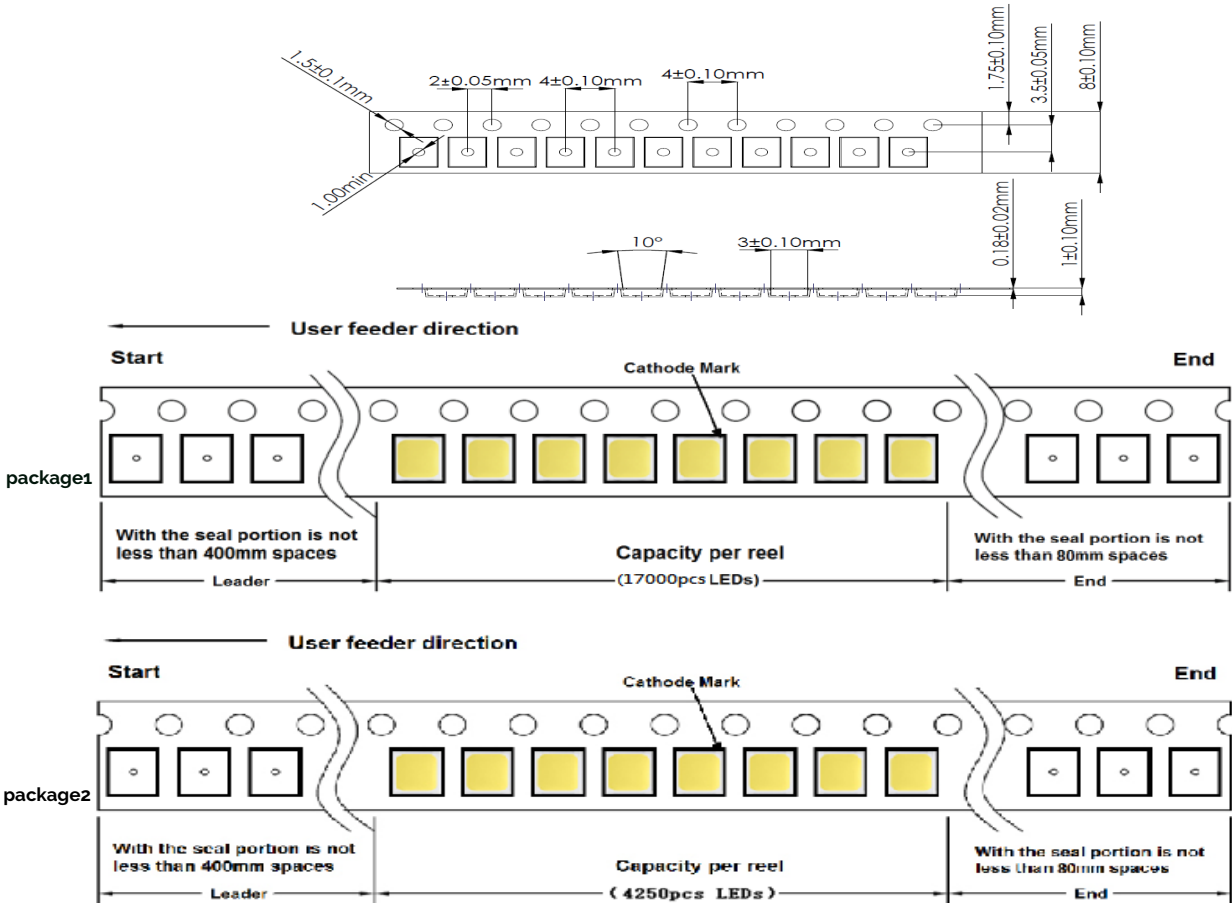

Note for Figure 13:

- 1. Drawings are not to scale. Drawing dimensions are in millimeters.

Packaging

Figure 14: Emitter Reel Packaging Drawings

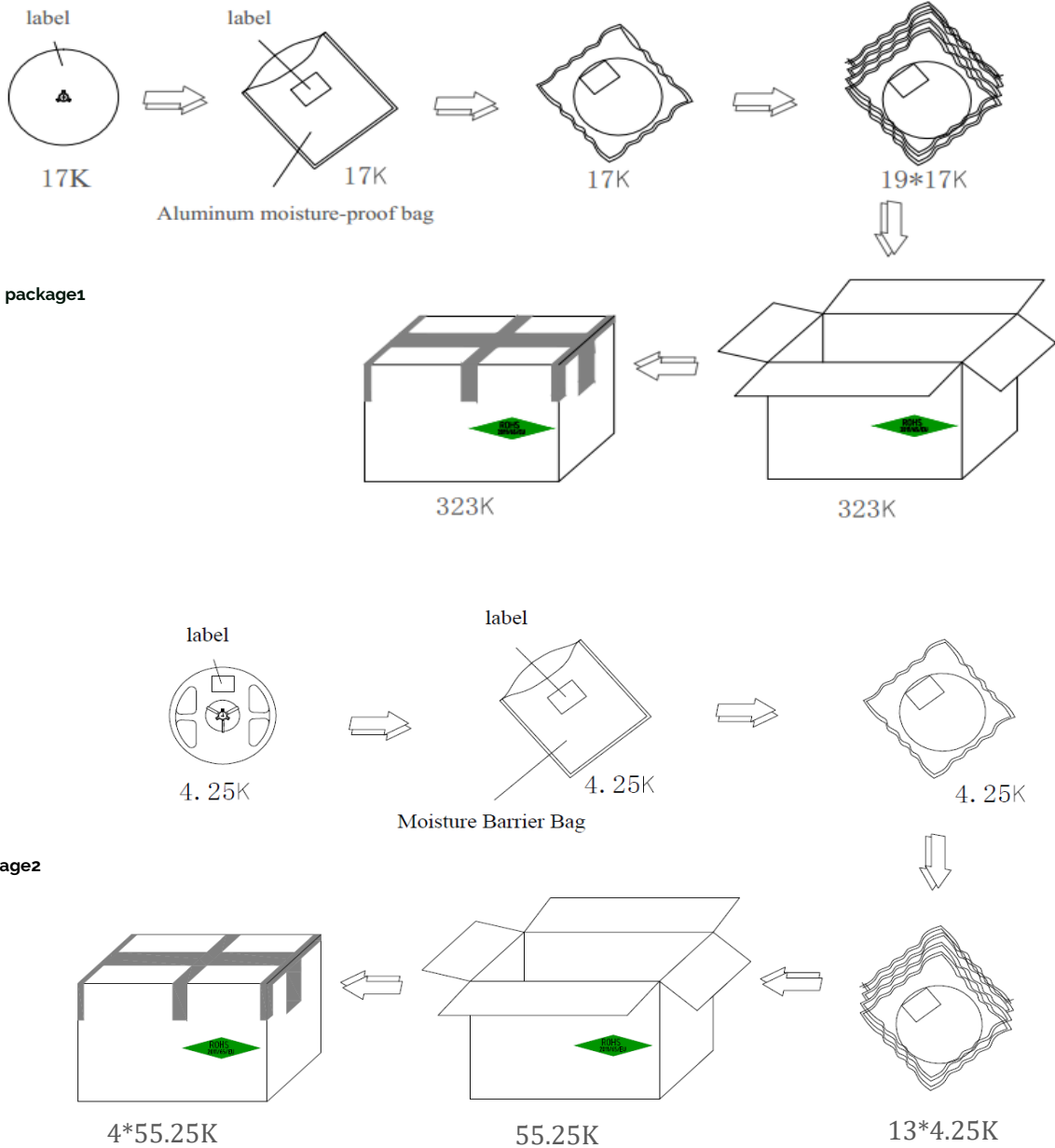

Note for Figure 14:
 1. Drawings are not to scale.

Design Resources

Please contact your Bridgelux sales representative for assistance.

Precautions

CAUTION: CHEMICAL EXPOSURE HAZARD

Exposure to some chemicals commonly used in luminaire manufacturing and assembly can cause damage to the LED emitter. Please consult Bridgelux Application Note AN51 for additional information.

CAUTION: EYE SAFETY

Eye safety classification for the use of Bridgelux SMD LED emitter is in accordance with IEC specification EN62471: Photobiological Safety of Lamps and Lamp Systems. SMD LED emitters are classified as Risk Group 1 when operated at or below the maximum drive current. Please use appropriate precautions. It is important that employees working with LEDs are trained to use them safely.

CAUTION: RISK OF BURN

Do not touch the SMD LED emitter during operation. Allow the emitter to cool for a sufficient period of time before handling. The SMD LED emitter may reach elevated temperatures such that could burn skin when touched.

CAUTION

CONTACT WITH LIGHT EMITTING SURFACE (LES)

Avoid any contact with the LES. Do not touch the LES of the emitter or apply stress to the LES (yellow phosphor resin area). Contact may cause damage to the emitter

Optics and reflectors must not be mounted in contact with the LES (yellow phosphor resin area).

Disclaimers

MINOR PRODUCT CHANGE POLICY

The rigorous qualification testing on products offered by Bridgelux provides performance assurance. Slight cosmetic changes that do not affect form, fit, or function may occur as Bridgelux continues product optimization.

STANDARD TEST CONDITIONS

Unless otherwise stated, LED emitter testing is performed at the nominal drive current.

About Bridgelux: Bridging Light and Life™

At Bridgelux, we help companies, industries and people experience the power and possibility of light. Since 2002, we've designed LED solutions that are high performing, energy efficient, cost effective and easy to integrate. Our focus is on light's impact on human behavior, delivering products that create better environments, experiences and returns—both experiential and financial. And our patented technology drives new platforms for commercial and industrial luminaires.

For more information about the company, please visit
bridgelux.com
twitter.com/Bridgelux
facebook.com/Bridgelux
youtube.com/user/Bridgelux
WeChat ID: BridgeluxInChina
https://www.linkedin.com/company/bridgelux-inc-_2



46410 Fremont Boulevard
Fremont, CA 94538 USA
Tel (925) 583-8400
Fax (925) 583-8401
www.bridgelux.com

© 2024 Bridgelux, Inc. All rights reserved 2024. Product specifications are subject to change without notice. Bridgelux and the Bridgelux stylized logo design are registered trademarks of Bridgelux, Inc. All other trademarks are the property of their respective owners.