

Bridgelux® SMD 5050 5W 6V

Product Data Sheet DS219-1

Introduction

SMD 5050

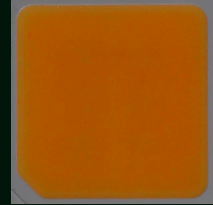

The Bridgelux SMD 5050 high power LED is hot-color targeted, which ensures that the LEDs fall within their specified color bin at the typical application conditions of 85°C. With its broad lumen coverage and wide range of CCT and CRI options, the SMD 5050 provides unparalleled design-in flexibility for indoor and outdoor lighting applications. The SMD 5050 is ideal as a drop-in replacement for emitters with an industry standard 5.0mm x 5.0mm footprint.

Features

- Industry-standard 5050 footprint
- 3 color bin options enable tight color control
- Hot-color targeting ensures that color is within the bin at the typical application condition of 85°C
- 3- and 5-step MacAdam ellipse options
- RoHS compliant and lead free
- Multiple CCT and CRI configurations for a wide range of lighting applications

Benefits

- Lower operating and manufacturing cost
- Ease of design and rapid go-to-market
- Uniform consistent white light
- Compliant with environmental standards
- Design flexibility

Contents

Product Feature Map	2
Product Nomenclature	2
Product Test Conditions	2
Product Selection Guide	4
Performance at Commonly Used Drive Currents	5
Electrical Characteristics	8
Absolute Maximum Ratings	9
Product Bin Definitions	10
Performance Curves	12
Typical Radiation Pattern	15
Typical Color Spectrum	16
Mechanical Dimensions	17
Reliability	18
Reflow Characteristics	19
Packaging	20
Design Resources	22
Precautions	22
Disclaimers	22
About Bridgelux	23

Product Feature Map

Bridgelux SMD LED products come in industry standard package sizes and follow ANSI binning standards. These LEDs are optimized for cost and performance, helping to ensure highly competitive system lumen per dollar performance while addressing the stringent efficacy and reliability standards required for modern lighting applications.

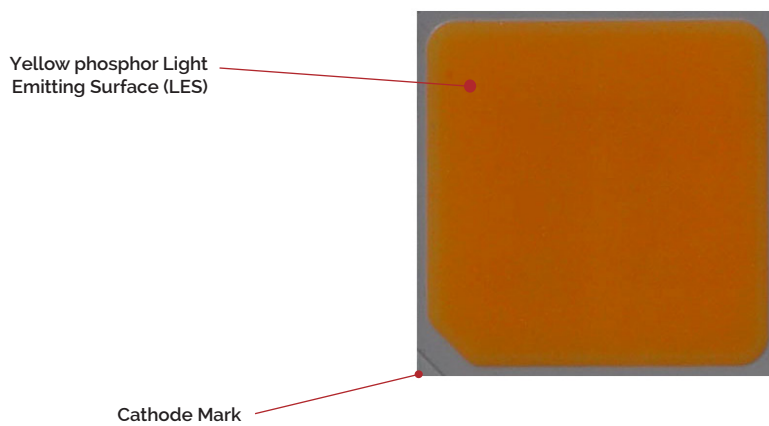

Product Nomenclature

The part number designation for Bridgelux SMD 5050 is explained as follows:

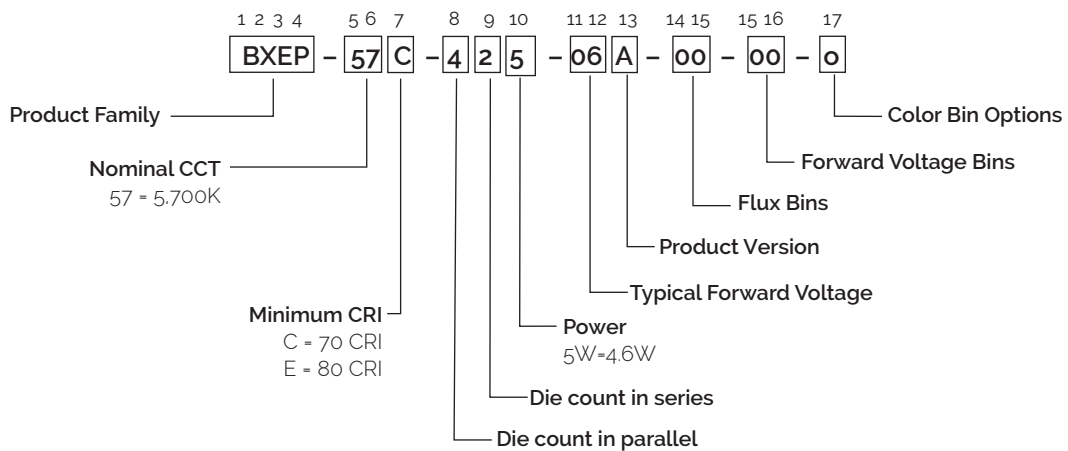

Product Selection Guide

The following product configurations are available:

Table 1: Selection Guide, Pulsed Measurement Data at 750mA ($T_j = T_{sp} = 25^\circ\text{C}$)

Part Number ^{2,6}	Nominal CCT ² (K)	CRI ^{3,5}	Nominal Drive Current (mA)	Forward Voltage ^{4,5} (V)			Typical Pulsed Flux (lm) ^{4,5}	Typical Power (W)	Typical Efficacy (lm/W)
				Min	Typical	Max			
BXEP-27C-425-06A-00-00-0	2700	70	750	5.8	6.3	6.6	697	4.7	148
BXEP-27E-425-06A-00-00-0	2700	80	750	5.8	6.3	6.6	645	4.7	137
BXEP-30C-425-06A-00-00-0	3000	70	750	5.8	6.3	6.6	719	4.7	153
BXEP-30E-425-06A-00-00-0	3000	80	750	5.8	6.3	6.6	665	4.7	141
BXEP-40C-425-06A-00-00-0	4000	70	750	5.8	6.3	6.6	765	4.7	162
BXEP-40E-425-06A-00-00-0	4000	80	750	5.8	6.3	6.6	708	4.7	150
BXEP-50C-425-06A-00-00-0	5000	70	750	5.8	6.3	6.6	765	4.7	162
BXEP-50E-425-06A-00-00-0	5000	80	750	5.8	6.3	6.6	708	4.7	150
BXEP-57C-425-06A-00-00-0	5700	70	750	5.8	6.3	6.6	758	4.7	161
BXEP-57E-425-06A-00-00-0	5700	80	750	5.8	6.3	6.6	701	4.7	149
BXEP-65C-425-06A-00-00-0	6500	70	750	5.8	6.3	6.6	758	4.7	161
BXEP-65E-425-06A-00-00-0	6500	80	750	5.8	6.3	6.6	701	4.7	149

Notes for Table 1 :

- The last 7 characters (including hyphens '-') refer to flux bins, forward voltage bins, and color bin options, respectively. "00-00-0" denotes the full distribution of flux, forward voltage, and 5 SDCM color.
Example: BXEP-57C-425-06A-00-00-0 refers to the full distribution of flux, forward voltage, and color within a 5700K 5-step ANSI standard chromaticity region with a minimum of 70CRI, 4x2 die configuration, 4.7w power, 6.3V typical forward voltage.
- Product CCT is hot targeted at $T_{sp} = 85^\circ\text{C}$. Nominal CCT as defined by ANSI C78.377-2011.
- Listed CRIs are minimum values and include test tolerance.
- Products tested under pulsed condition (10ms pulse width) at nominal drive current where $T_j = T_{sp} = 25^\circ\text{C}$.
- Bridgelux maintains a $\pm 7.5\%$ tolerance on luminous flux measurements, $\pm 0.1\text{V}$ tolerance on forward voltage measurements, and ± 2 tolerance on CRI measurements for the SMD 5050.
- Refer to Table 6 and Table 7 for Bridgelux SMD 5050 Luminous Flux Binning and Forward Voltage Binning information.

Product Selection Guide

The following product configurations are available:

Table 2: Selection Guide, Stabilized DC Performance ($T_{sp} = 85^{\circ}\text{C}$)^{6,7}

Part Number	Nominal CCT ¹ (K)	CRI ^{2,3}	Nominal Drive Current (mA)	Forward Voltage ³ (V)			Typical DC Flux (lm) ³	Typical DC Power (W)	Typical DC Effi- cacy (lm/W)
				Min	Typical	Max			
BXEP-27C-425-06A-00-00-0	2700	70	750	5.7	6.2	6.5	620	4.6	133
BXEP-27E-425-06A-00-00-0	2700	80	750	5.7	6.2	6.5	574	4.6	124
BXEP-30C-425-06A-00-00-0	3000	70	750	5.7	6.2	6.5	640	4.6	138
BXEP-30E-425-06A-00-00-0	3000	80	750	5.7	6.2	6.5	592	4.6	127
BXEP-40C-425-06A-00-00-0	4000	70	750	5.7	6.2	6.5	681	4.6	146
BXEP-40E-425-06A-00-00-0	4000	80	750	5.7	6.2	6.5	630	4.6	136
BXEP-50C-425-06A-00-00-0	5000	70	750	5.7	6.2	6.5	681	4.6	146
BXEP-50E-425-06A-00-00-0	5000	80	750	5.7	6.2	6.5	630	4.6	136
BXEP-57C-425-06A-00-00-0	5700	70	750	5.7	6.2	6.5	674	4.6	145
BXEP-57E-425-06A-00-00-0	5700	80	750	5.7	6.2	6.5	624	4.6	134
BXEP-65C-425-06A-00-00-0	6500	70	750	5.7	6.2	6.5	674	4.6	145
BXEP-65E-425-06A-00-00-0	6500	80	750	5.7	6.2	6.5	624	4.6	134

Notes for Table 2:

- The last 7 characters (including hyphens '-') refer to flux bins, forward voltage bins, and color bin options, respectively. "00-00-0" denotes the full distribution of flux, forward voltage, and 5 SDCM color.
Example: BXEP-57C-425-06A-00-00-0 refers to the full distribution of flux, forward voltage, and color within a 5700K 5-step ANSI standard chromaticity region with a minimum of 70CRI, 4x2 die configuration, 4.6w power, 6.2V typical forward voltage.
- Product CCT is hot targeted at $T_{sp} = 85^{\circ}\text{C}$. Nominal CCT as defined by ANSI C78.377-2011.
- Listed CRIs are minimum values and include test tolerance.
- Bridgelux maintains a $\pm 7.5\%$ tolerance on luminous flux measurements, $\pm 0.1\text{V}$ tolerance on forward voltage measurements, and ± 2 tolerance on CRI measurements for the SMD 5050.
- Refer to Table 6 and Table 7 for Bridgelux SMD 5050 Luminous Flux Binning and Forward Voltage Binning information.
- Typical stabilized DC performance values are provided as reference only and are not a guarantee of performance.
- Typical performance is estimated based on operation under DC (direct current) with LED emitter mounted onto a heat sink with thermal interface material and the solder point temperature maintained at 85°C . Based on Bridgelux test setup, values may vary depending on the thermal design of the luminaire and/or the exposed environment to which the product is subjected.

Performance at Commonly Used Drive Currents

SMD 5050 LEDs are tested to the specifications shown using the nominal drive currents in Table 1. SMD 5050 may also be driven at other drive currents dependent on specific application design requirements. The performance at any drive current can be derived from the current vs. voltage characteristics shown in Figure 2 and the relative luminous flux vs. current characteristics shown in Figure 3. The performance at commonly used drive currents is summarized in Table 3.

Table 3: Performance at Commonly Used Drive Currents

Part Number	CRI	Drive Current ¹ (mA)	Typical V_f $T_{sp} = 25^\circ\text{C}$ (V)	Typical Power $T_{sp} = 25^\circ\text{C}$ (W)	Typical Pulsed Flux ² $T_{sp} = 25^\circ\text{C}$ (lm)	Typical DC Flux ³ $T_{sp} = 85^\circ\text{C}$ (lm)	Typical Efficacy $T_{sp} = 25^\circ\text{C}$ (lm/W)
BXEP-27C-425-06A-00-00-0	70	150	5.5	0.8	155	144	188
		180	5.5	1.0	185	171	186
		300	5.7	1.7	302	278	176
		450	5.9	2.7	441	401	166
		600	6.1	3.7	573	515	156
		750	6.3	4.7	697	620	148
		800	6.3	5.1	735	655	145
BXEP-27E-425-06A-00-00-0	80	150	5.5	0.8	143	133	174
		180	5.5	1.0	171	158	172
		300	5.7	1.7	280	257	163
		450	5.9	2.7	408	371	153
		600	6.1	3.7	530	477	145
		750	6.3	4.7	645	574	137
		800	6.3	5.1	680	606	134
BXEP-30C-425-06A-00-00-0	70	150	5.5	0.8	159	149	194
		180	5.5	1.0	191	176	192
		300	5.7	1.7	312	286	182
		450	5.9	2.7	454	413	171
		600	6.1	3.7	591	532	161
		750	6.3	4.7	719	640	153
		800	6.3	5.1	758	676	149
BXEP-30E-425-06A-00-00-0	80	150	5.5	0.8	147	138	179
		180	5.5	1.0	176	163	177
		300	5.7	1.7	288	265	168
		450	5.9	2.7	420	382	158
		600	6.1	3.7	546	492	149
		750	6.3	4.7	665	592	141
		800	6.3	5.1	701	625	138

Performance at Commonly Used Drive Currents

SMD 5050 LEDs are tested to the specifications shown using the nominal drive currents in Table 1. SMD 5050 may also be driven at other drive currents dependent on specific application design requirements. The performance at any drive current can be derived from the current vs. voltage characteristics shown in Figure 2 and the relative luminous flux vs. current characteristics shown in Figure 3. The performance at commonly used drive currents is summarized in Table 3.

Table 3: Performance at Commonly Used Drive Currents

Part Number	CRI	Drive Current ¹ (mA)	Typical V_f $T_{sp} = 25^\circ\text{C}$ (V)	Typical Power $T_{sp} = 25^\circ\text{C}$ (W)	Typical Pulsed Flux ² $T_{sp} = 25^\circ\text{C}$ (lm)	Typical DC Flux ³ $T_{sp} = 85^\circ\text{C}$ (lm)	Typical Efficacy $T_{sp} = 25^\circ\text{C}$ (lm/W)
BXEP-40C-425-06A-00-00-0	70	150	5.5	0.8	170	158	206
		180	5.5	1.0	203	187	204
		300	5.7	1.7	332	305	194
		450	5.9	2.7	484	440	182
		600	6.1	3.7	629	566	172
		750	6.3	4.7	765	681	162
		800	6.3	5.1	807	719	159
BXEP-40E-425-06A-00-00-0	80	150	5.5	0.8	157	146	191
		180	5.5	1.0	188	173	189
		300	5.7	1.7	307	282	179
		450	5.9	2.7	447	407	168
		600	6.1	3.7	582	523	159
		750	6.3	4.7	708	630	150
		800	6.3	5.1	747	665	147
BXEP-50C-425-06A-00-00-0	70	150	5.5	0.8	170	158	206
		180	5.5	1.0	203	187	204
		300	5.7	1.7	332	305	194
		450	5.9	2.7	484	440	182
		600	6.1	3.7	629	566	172
		750	6.3	4.7	765	681	162
		800	6.3	5.1	807	719	159
BXEP-50E-425-06A-00-00-0	80	150	5.5	0.8	157	146	191
		180	5.5	1.0	188	173	189
		300	5.7	1.7	307	282	179
		450	5.9	2.7	447	407	168
		600	6.1	3.7	582	523	159
		750	6.3	4.7	708	630	150
		800	6.3	5.1	747	665	147

Performance at Commonly Used Drive Currents

SMD 5050 LEDs are tested to the specifications shown using the nominal drive currents in Table 1. SMD 5050 may also be driven at other drive currents dependent on specific application design requirements. The performance at any drive current can be derived from the current vs. voltage characteristics shown in Figure 2 and the relative luminous flux vs. current characteristics shown in Figure 3. The performance at commonly used drive currents is summarized in Table 3.

Table 3: Performance at Commonly Used Drive Currents

Part Number	CRI	Drive Current ¹ (mA)	Typical V _f T _{sp} = 25°C (V)	Typical Power T _{sp} = 25°C (W)	Typical Pulsed Flux ² T _{sp} = 25°C (lm)	Typical DC Flux ³ T _{sp} = 85°C (lm)	Typical Efficacy T _{sp} = 25°C (lm/W)
BXEP-57C-425-06A-00-00-0	70	150	5.5	0.8	168	157	204
		180	5.5	1.0	201	186	202
		300	5.7	1.7	328	302	192
		450	5.9	2.7	479	436	180
		600	6.1	3.7	623	560	170
		750	6.3	4.7	758	674	161
		800	6.3	5.1	799	712	158
BXEP-57E-425-06A-00-00-0	80	150	5.5	0.8	155	145	189
		180	5.5	1.0	186	172	187
		300	5.7	1.7	304	279	177
		450	5.9	2.7	443	403	167
		600	6.1	3.7	576	518	157
		750	6.3	4.7	701	624	149
		800	6.3	5.1	739	659	146
BXEP-65C-425-06A-00-00-0	70	150	5.48	0.8	168	157	204
		180	5.53	1.0	201	186	202
		300	5.71	1.7	328	302	192
		450	5.91	2.7	479	436	180
		600	6.10	3.7	623	560	170
		750	6.28	4.7	758	674	161
		800	6.34	5.1	799	712	158
BXEP-65E-425-06A-00-00-0	80	150	5.5	0.8	155	145	189
		180	5.5	1.0	186	172	187
		300	5.7	1.7	304	279	177
		450	5.9	2.7	443	403	167
		600	6.1	3.7	576	518	157
		750	6.3	4.7	701	624	149
		800	6.3	5.1	739	659	146

Electrical Characteristics

Table 4: Electrical Characteristics

Part Number	Drive Current (mA)	Forward Voltage (V) ^{1,2}			Typical Temperature Coefficient of Forward Voltage $\Delta V_f / \Delta T$ (mV/°C)	Typical Thermal Resistance Junction to Solder Point ⁴ R_{j-sp} (°C/W)
		Minimum	Typical	Maximum		
BXEP-XXX-425-06A-00-00-0	750	5.8	6.3	6.6	-0.91	3.2

Notes for Table 4:

1. Bridgelux maintains a tolerance of $\pm 0.1V$ on forward voltage measurements. Voltage minimum and maximum values at the nominal drive current are guaranteed by 100% test.
2. Products tested under pulsed condition (10ms pulse width) at nominal drive current where $T_{sp} = 25^\circ C$.
3. Thermal Resistance values based on 3000K 70CRI product.
4. Thermal resistance value was calculated using total electrical input power; optical power was not subtracted from input power.

Absolute Maximum Ratings

Table 5: Maximum Ratings

Parameter	Maximum Rating
LED Junction Temperature (T_j)	125°C
Storage Temperature	-40°C to +105°C
Operating Solder Point Temperature (T_{sp})	-40°C to +105°C
Soldering Temperature	260°C or lower for a maximum of 10 seconds
Maximum Drive Current ¹	960 mA
Maximum Peak Pulsed Forward Current ²	1200 mA
Maximum Reverse Voltage ³	-
Moisture Sensitivity Rating	MSL 3
Electrostatic Discharge	2kV HBM. JEDEC-JS-001-HBM and JEDEC-JS-001-2012

Notes for Table 5:

1. Maximum drive current may be limited by the solder point temperature. Please see Figure 7 for further details.
2. Bridgelux recommends a maximum duty cycle of 10% and pulse width of 10 ms when operating LED SMD at maximum peak pulsed current specified. Maximum peak pulsed current indicate values where LED SMD can be driven without catastrophic failures.
3. Light emitting diodes are not designed to be driven in reverse voltage and will not produce light under this condition, no rating is provided.

Product Bin Definitions

Table 6 lists the standard photometric luminous flux bins for Bridgelux SMD 5050 LEDs. Although several bins are listed, product availability in a particular bin varies by production run and by product performance. Not all bins are available in all CCTs.

Table 6: Luminous Flux Bin Definitions at 750mA, $T_{sp}=25^{\circ}\text{C}$

Bin Code	Minimum	Maximum	Unit	Condition
B1	590	635	lm	$I_F=750\text{mA}$
B2	635	685		
B3	685	740		
B4	740	800		
B5	800	865		

Note for Table 6:

1. Bridgelux maintains a tolerance of $\pm 7.5\%$ on luminous flux measurements.

Table 7: Forward Voltage Bin Definition at 750mA, $T_{sp}=25^{\circ}\text{C}$

Bin Code	Minimum	Maximum	Unit	Condition
BO	5.8	6.0	V	$I_F=750\text{mA}$
BP	6.0	6.2		
BQ	6.2	6.4		
BR	6.4	6.6		

Note for Table 7:

1. Bridgelux maintains a tolerance of $\pm 0.1\text{V}$ on forward voltage measurements.

Product Bin Definitions

Table 8: 3- and 5-step MacAdam Ellipse Color Bin Definitions

CCT	Color Space	Center Point		Major Axis	Minor Axis	Ellipse Rotation Angle	Color Bin
		X	Y				
2700K	3 SDCM	0.4578	0.4101	0.00810	0.00420	53.70	3
	5 SDCM	0.4578	0.4101	0.01350	0.00700	53.70	5
3000K	3 SDCM	0.4338	0.4030	0.00834	0.00408	53.22	3
	5 SDCM	0.4338	0.4030	0.01390	0.00680	53.22	5
4000K	3 SDCM	0.3818	0.3797	0.00939	0.00402	53.72	3
	5 SDCM	0.3818	0.3797	0.01565	0.00670	53.72	5
5000K	3 SDCM	0.3447	0.3553	0.00822	0.00354	59.62	3
	5 SDCM	0.3447	0.3553	0.01370	0.00590	59.62	5
5700K	3 SDCM	0.3287	0.3417	0.00746	0.00320	59.09	3
	5 SDCM	0.3287	0.3417	0.01243	0.00533	59.09	5
6500K	3 SDCM	0.3123	0.3282	0.00669	0.00285	58.57	3
	5 SDCM	0.3123	0.3282	0.01115	0.00475	58.57	5

Notes for Table 8:

1. Color binning at $T_{sp} = 85^{\circ}\text{C}$
2. Bridgelux maintains a tolerance of ± 0.007 on x and y color coordinates in the CIE 1931 color space.

Figure 1: C.I.E. 1931 Chromaticity Diagram (2 Color Bin Structure, Hot-color Targeted at $T_{sp} = 85^{\circ}\text{C}$)

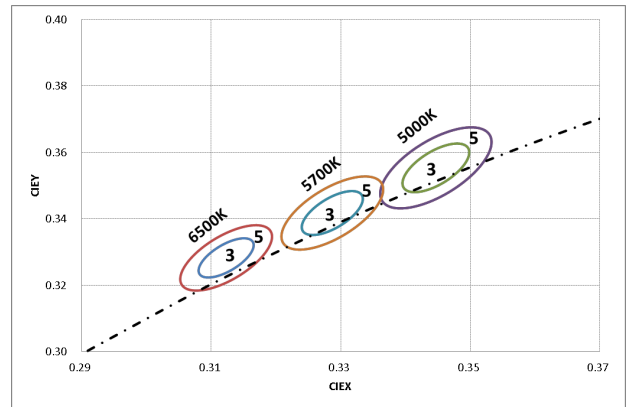
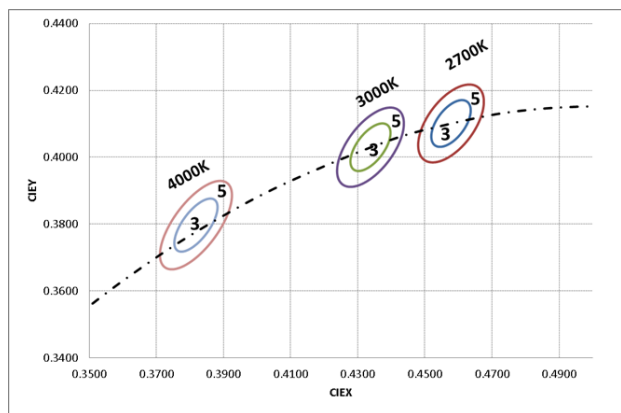

Performance Curves

Figure 2: Drive Current vs. Voltage ($T_{sp}=25^{\circ}\text{C}$)

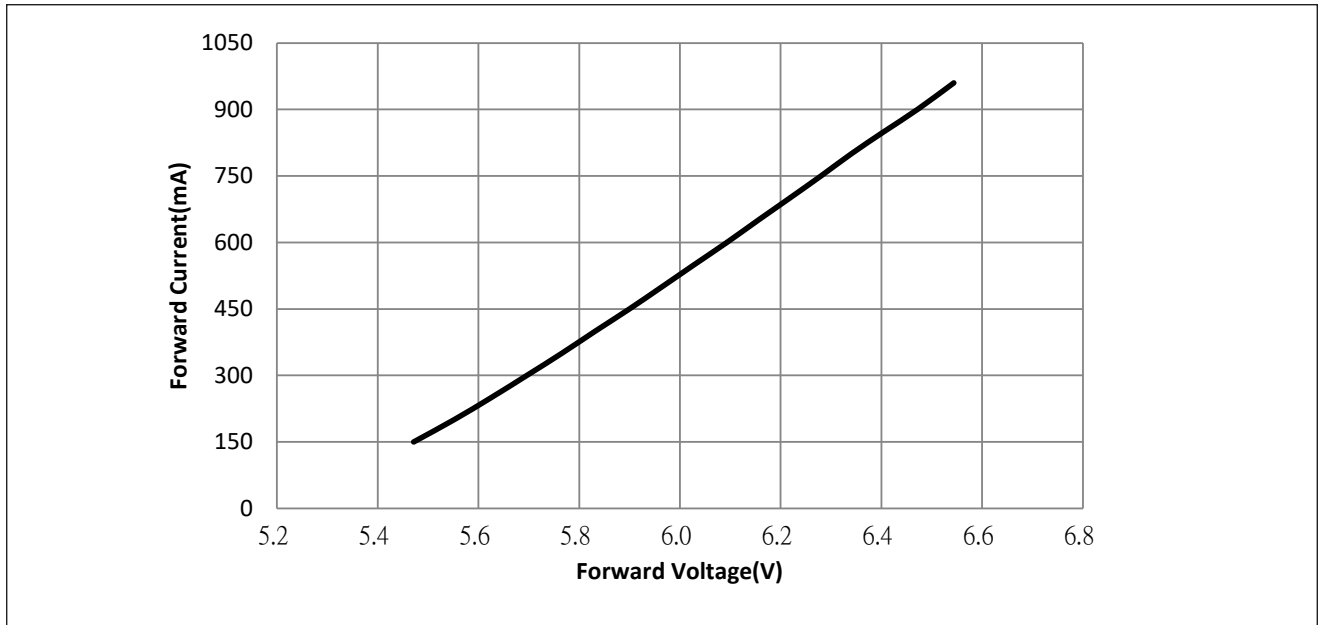
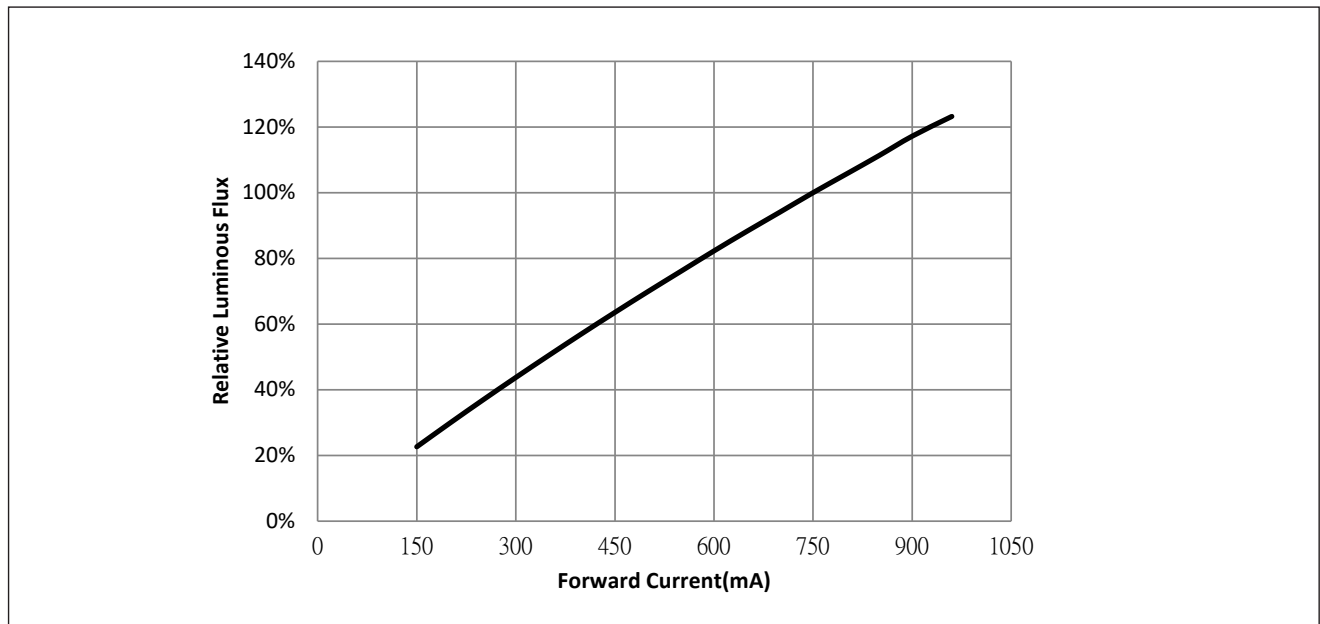

Figure 3: Typical Relative Luminous Flux vs. Drive Current ($T_{sp}=25^{\circ}\text{C}$)



Note for Figure 3:

1. Bridgelux does not recommend driving high power LEDs at low currents. Doing so may produce unpredictable results. Pulse width modulation (PWM) is recommended for dimming effects.

Performance Curves

Figure 4: Typical Relative DC Flux vs. Solder Point Temperature

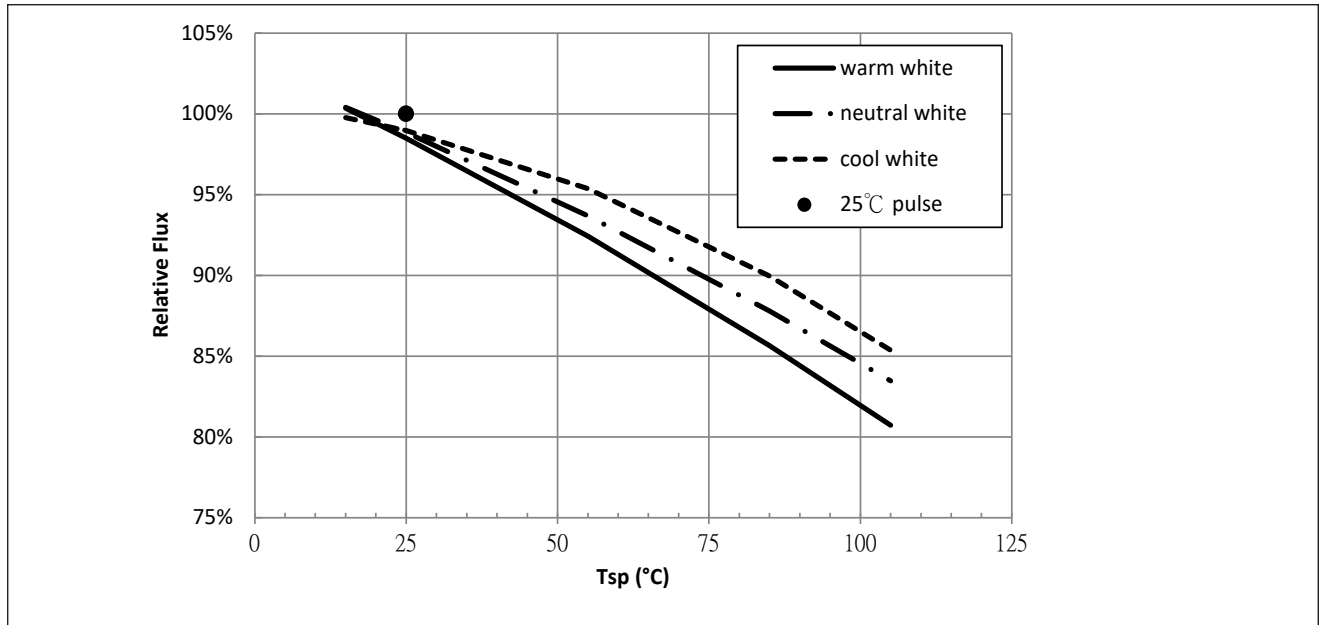
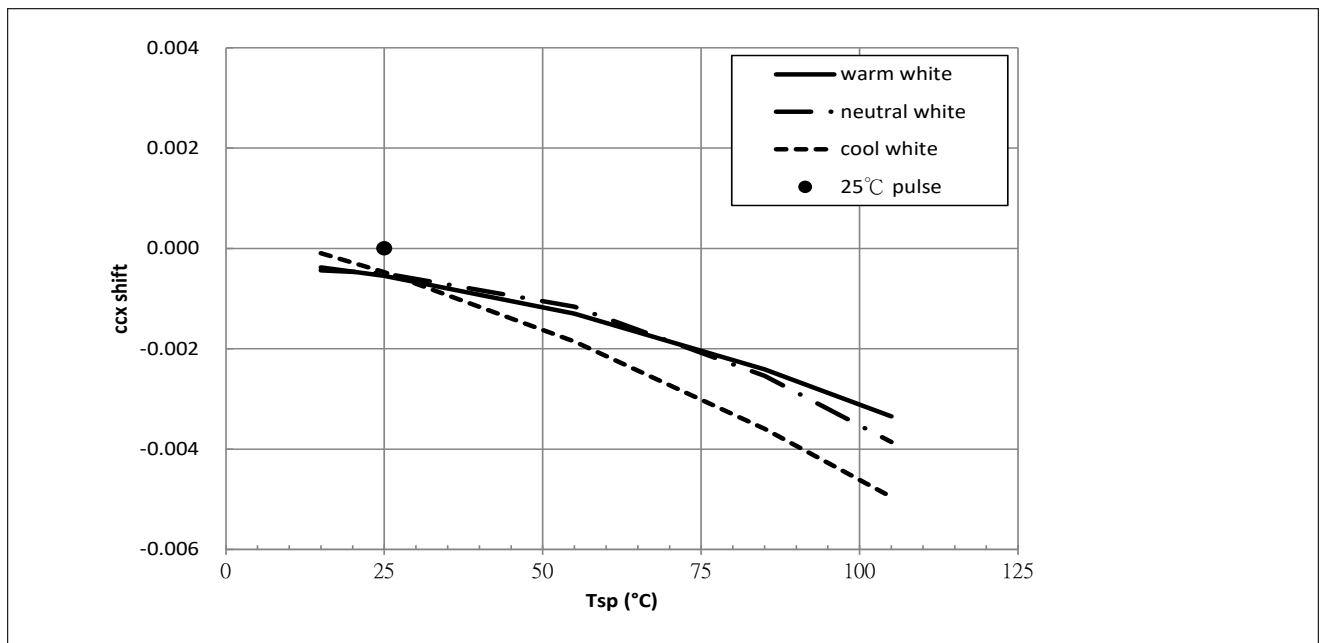

Figure 5: Typical DC ccx Shift vs. Solder Point Temperature



Notes for Figures 4 & 5:

1. Characteristics shown for warm white based on 3000K.
2. Characteristics shown for neutral white based on 4000K.
3. Characteristics shown for cool white based on 5700K.
4. For other color SKUs, the shift in color will vary. Please contact your Bridgelux Sales Representative for more information.

Performance Curves

Figure 6: Typical DC ccy Shift vs. Solder Point Temperature

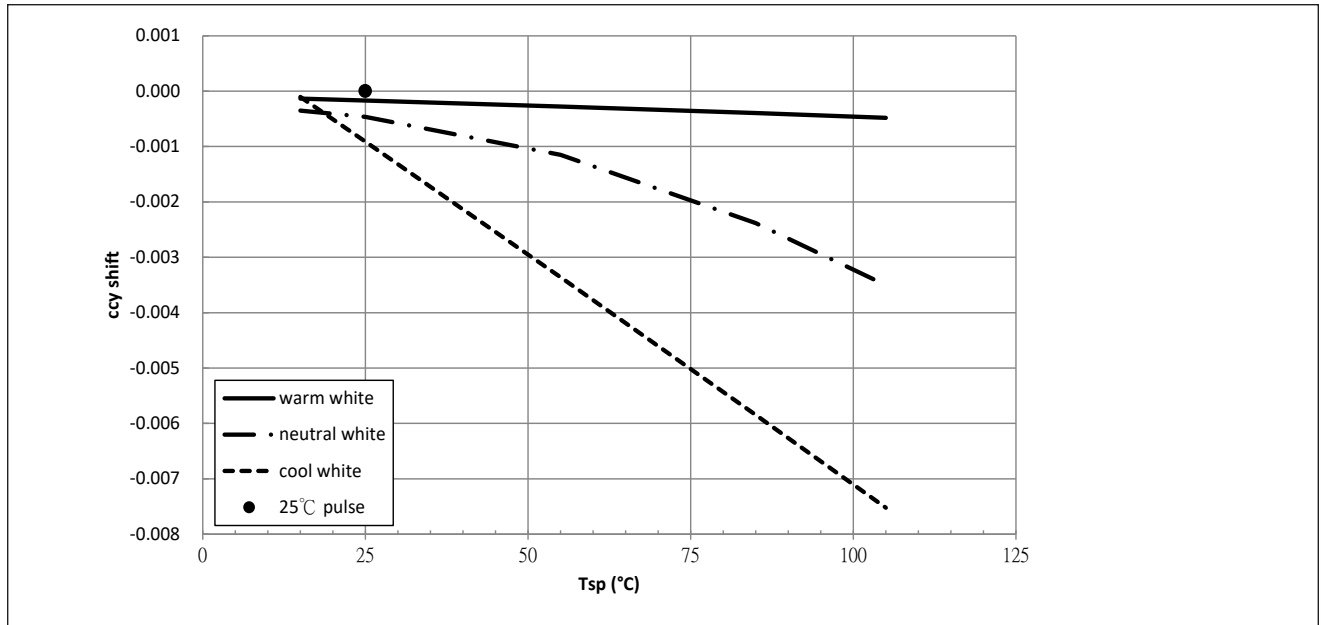

Notes for Figure 6:

1. Characteristics shown for warm white based on 3000K.
2. Characteristics shown for neutral white based on 4000K.
3. Characteristics shown for cool white based on 5700K.
4. For other color SKUs, the shift in color will vary. Please contact your Bridgelux Sales Representative for more information.

Figure 7: Drive Current Derating Curve

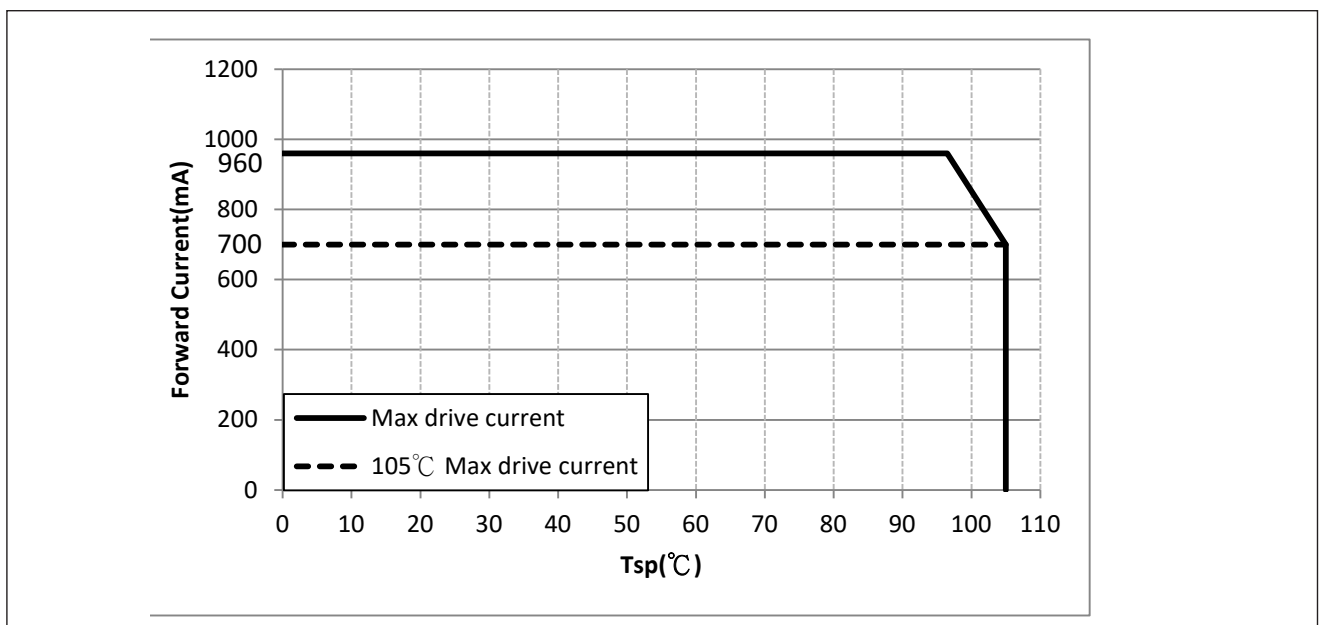

Typical Radiation Pattern

Figure 8: Typical Spatial Radiation Pattern at 750mA, $T_{sp} = 25^{\circ}\text{C}$

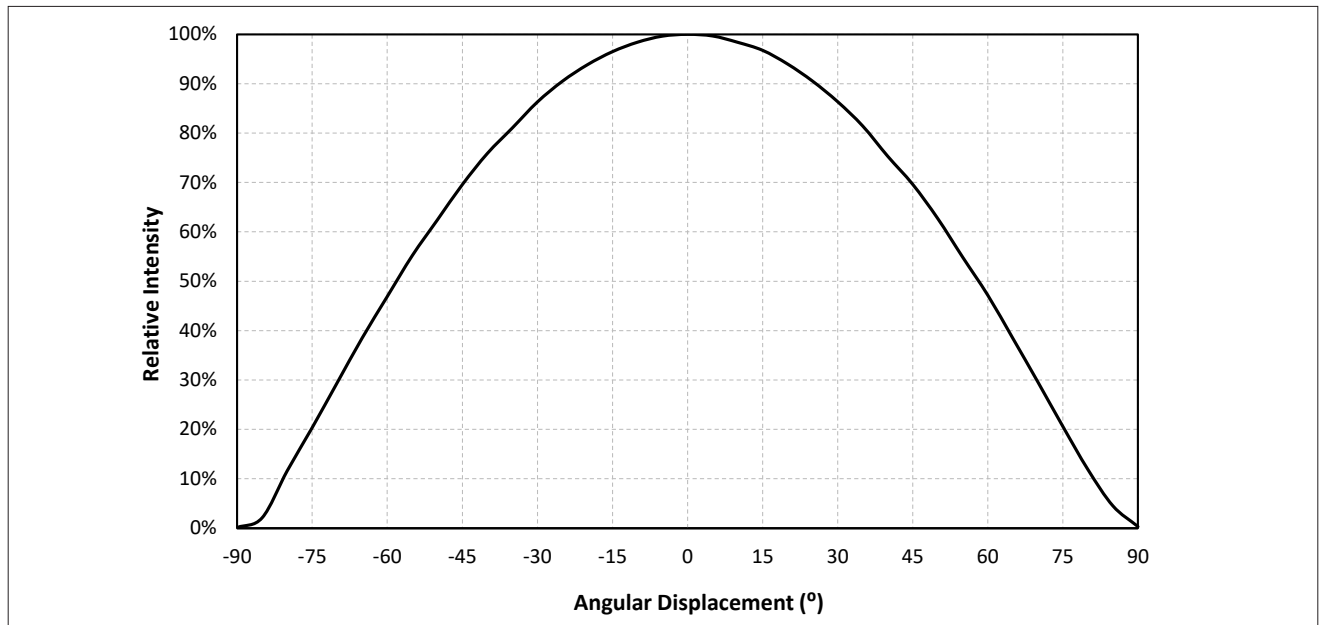

Notes for Figure 8:

1. Typical viewing angle is 116° .
2. The viewing angle is defined as the off axis angle from the centerline where luminous intensity (lv) is $\frac{1}{2}$ of the peak value.

Figure 9: Typical Polar Radiation Pattern at 750mA, $T_{sp} = 25^{\circ}\text{C}$

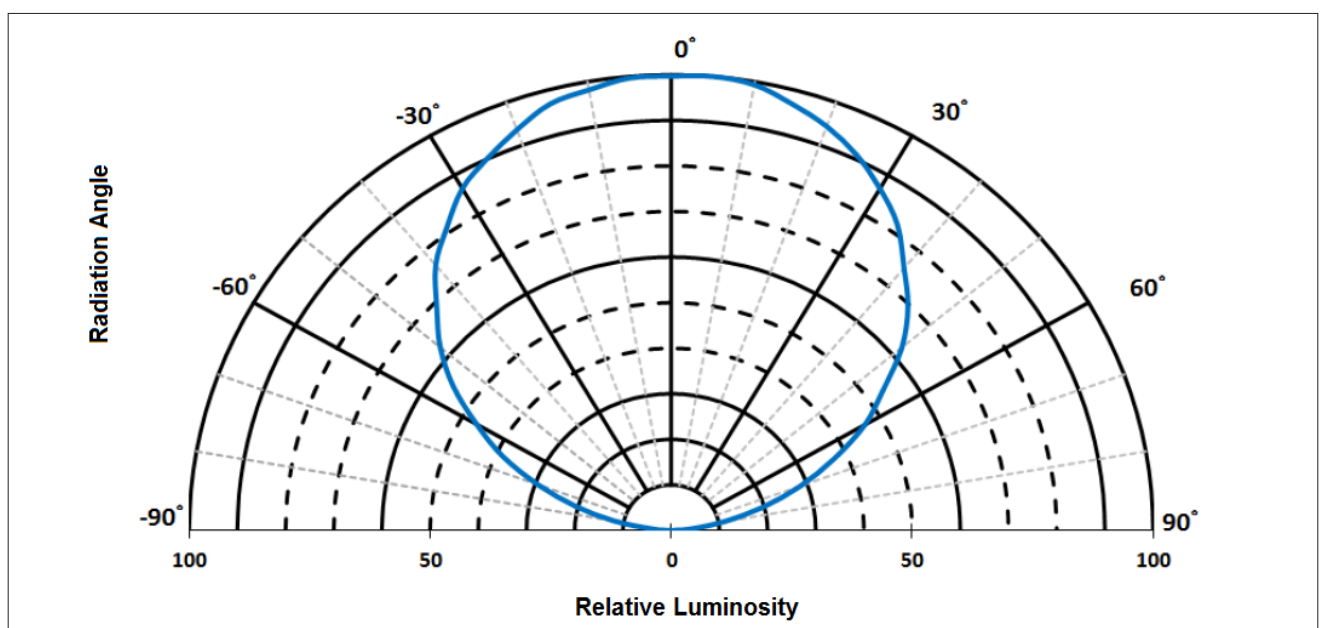

Typical Color Spectrum

Figure 10: Typical Color Spectrum

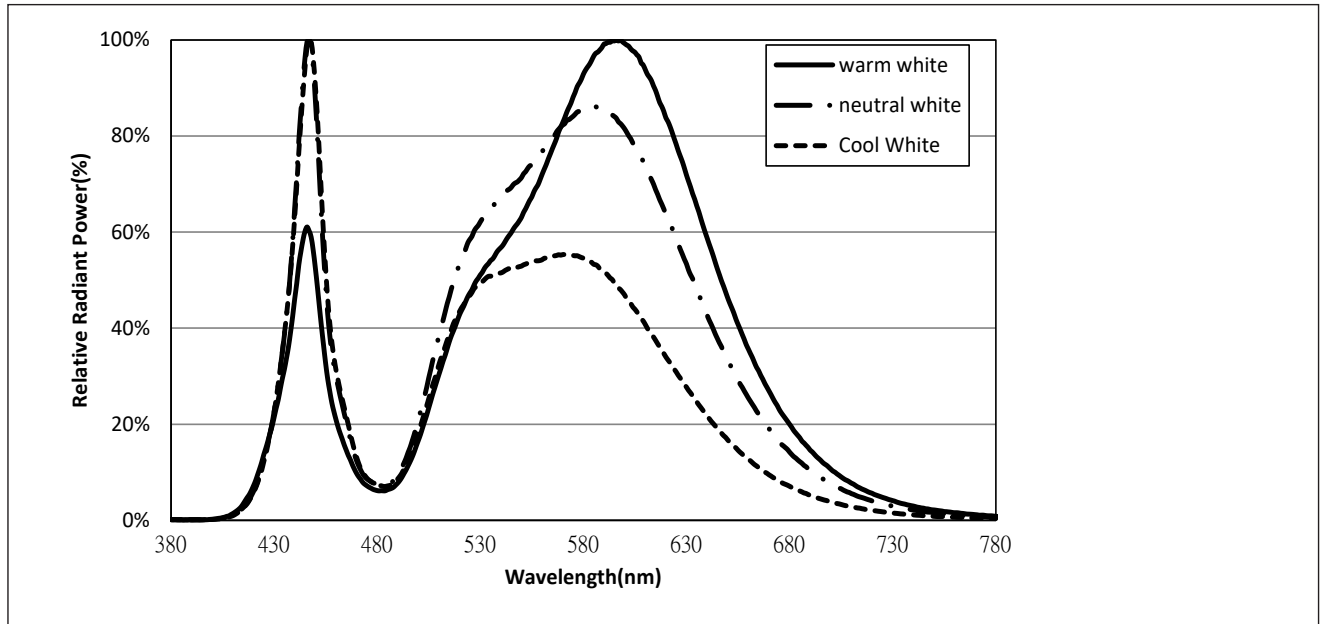

Notes for Figure 10:

1. Color spectra measured at nominal current for $T_{sp} = 25^{\circ}\text{C}$
2. Color spectra shown for warm white is 3000K
3. Color spectra shown for neutral white is 4000K
4. Color spectra shown for cool white is 5700K

Mechanical Dimensions

Figure 11: Drawing for SMD 5050

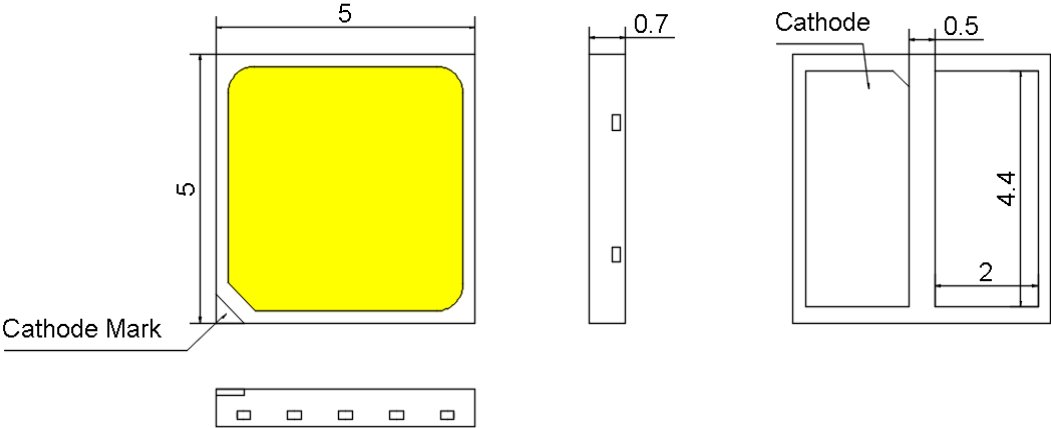

- Notes for Figure 11:
- 1. Drawings are not to scale.
 - 2. Drawing dimensions are in millimeters.
 - 3. Unless otherwise specified, tolerances are $\pm 0.10\text{mm}$.

Recommended PCB Soldering Pad Pattern

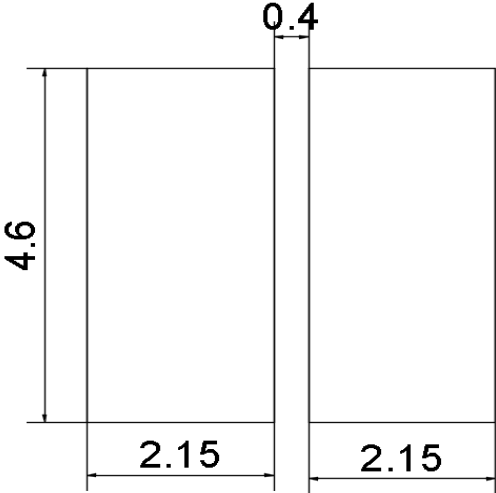

Reliability

Table 9: Reliability Test Items and Conditions

No.	Items	Reference Standard	Test Conditions	Drive Current	Test Duration	Units Failed/Tested
1	Moisture/Reflow Sensitivity	J-STD-020E	$T_{\text{slid}} = 260^{\circ}\text{C}$, 10sec, Precondition: 60°C , 60%RH, 168hr	-	3 reflows	0/22
2	Low Temperature Storage	JESD22-A119	$T_{\text{a}} = -40^{\circ}\text{C}$	-	1000 hours	0/22
3	High Temperature Storage	JESD22-A103D	$T_{\text{a}} = 105^{\circ}\text{C}$	-	1000 hours	0/22
4	Low Temperature Operating Life	JESD22-A108D	$T_{\text{a}} = -40^{\circ}\text{C}$	750mA	1000 hours	0/22
5	Temperature Humidity Operating Life	JESD22-A101C	$T_{\text{sp}} = 85^{\circ}\text{C}$, RH=85%	750mA	1000 hours	0/22
6	High Temperature Operating Life	JESD22-A108D	$T_{\text{sp}} = 105^{\circ}\text{C}$	700mA	1000 hours	0/22
7	Thermal Shock	JESD22-A106B	$T_{\text{a}} = -40^{\circ}\text{C} \sim 100^{\circ}\text{C}$; Dwell : 15min; Transfer: 10sec	-	200 cycles	0/22
8	Temperature Cycle	JESD22-A104E	$T_{\text{a}} = -40^{\circ}\text{C} \sim 100^{\circ}\text{C}$; Dwell at extreme temperature: 15min; Ramp rate < $105^{\circ}\text{C}/\text{min}$	-	200 cycles	0/22
9	Electrostatic Discharge	JS-001-2012	HBM, 2kV, 15k Ω , 100pF, Alternately positive or negative	-	-	0/22

Passing Criteria

Item	Symbol	Test Condition	Passing Criteria
Forward Voltage	Vf	750mA	$\Delta V_f < 10\%$
Luminous Flux	Fv	750mA	$\Delta F_v < 30\%$
Chromaticity Coordinates	(x, y)	750mA	$\Delta u'v' < 0.007$

Notes for Table 9:

- Measurements are performed after allowing the LEDs to return to room temperature
- T_{slid} : reflow soldering temperature; T_{a} : ambient temperature

Reflow Characteristics

Figure 12 : Reflow Profile

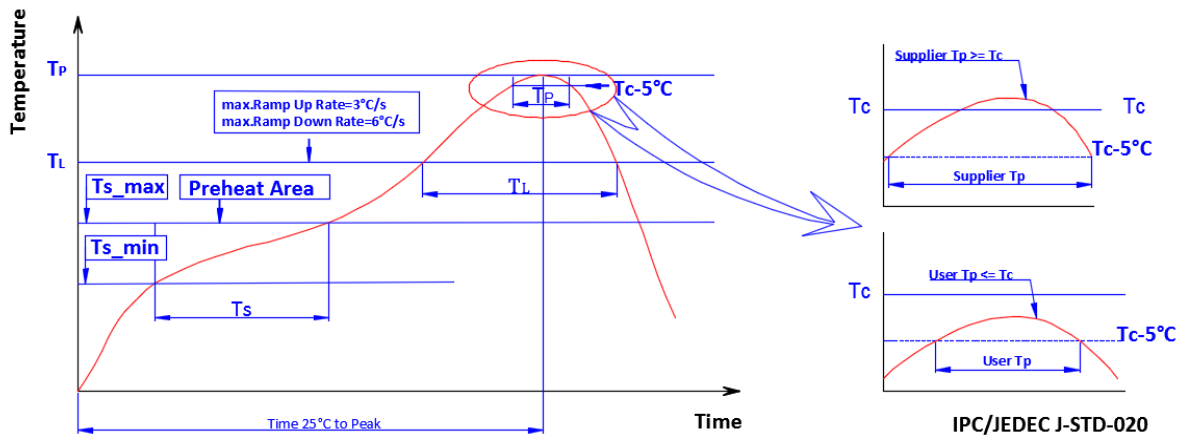

Profile Feature	Lead Free Assembly
Temperature Min. (Ts_min)	160°C
Temperature Max. (Ts_max)	205°C
Time (ts) from Ts_min to Ts_max	60-150 seconds
Ramp-Up Rate (TL to Tp)	3 °C/second
Liquidus Temperature (TL)	220 °C
Time (TL) Maintained Above TL	60-150 seconds
Peak Temp(Tp)	260 °C max.
Time (Tp) Within 5 °C of the Specified Classification Temperature (Tc)	25 seconds max.
Ramp-Down Rate (Tp to TL)	5 °C/second max.
Time 25 °C to Peak Temperature	10 minutes max.

Figure 13: Pick and Place

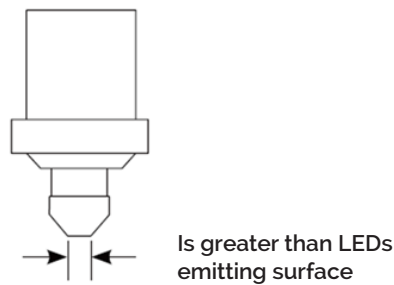

Note for Figure 13:

- When using a pick and place machine, choose a nozzle that has a larger diameter than the LED's emitting surface. Using a Pick-and-Place nozzle with a smaller diameter than the size of the LEDs emitting surface will cause damage and may also cause the LED to not illuminate.

Packaging

Figure 14: Emitter Reel Drawings

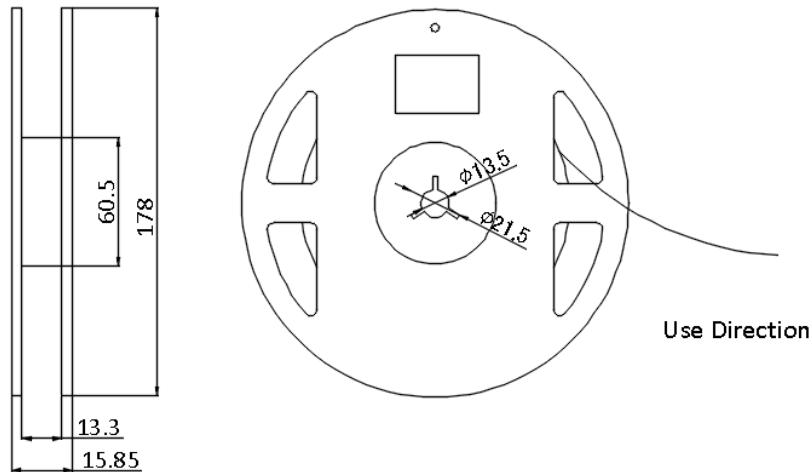

Note for Figure 14:

1. Drawings are not to scale. Drawing dimensions are in millimeters.

Figure 15: Emitter Tape Drawings

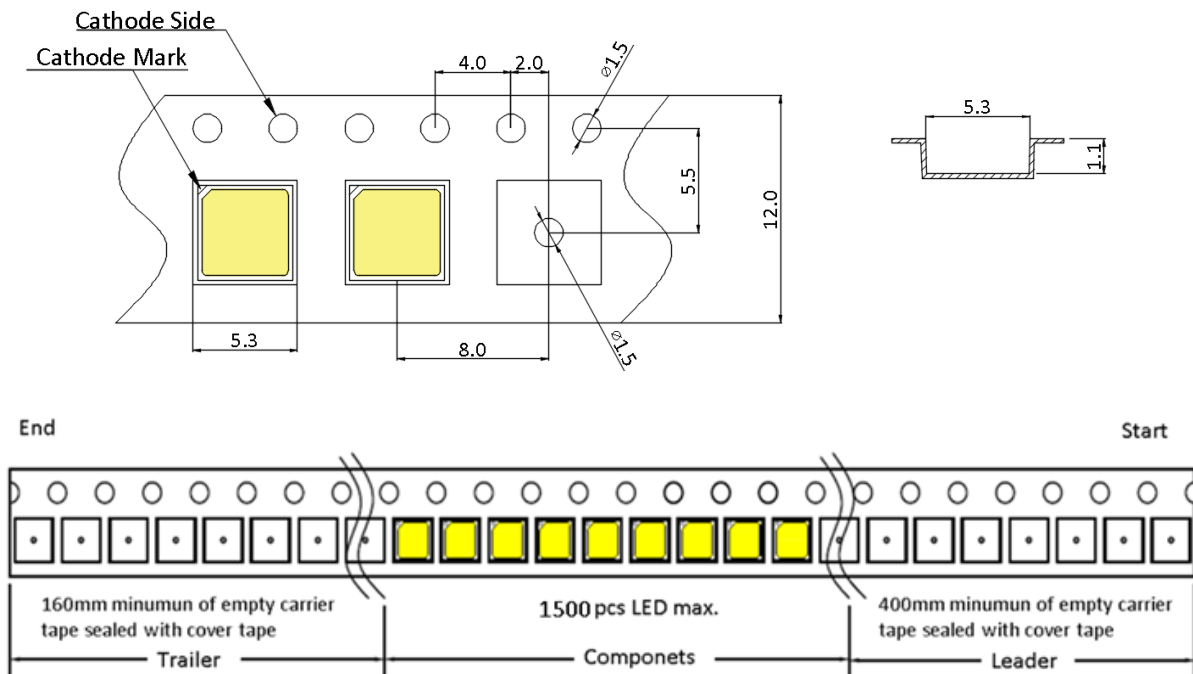

Note for Figure 15:

1. Drawings are not to scale. Drawing dimensions are in millimeters.

Packaging

Figure 16: Emitter Reel Packaging Drawings

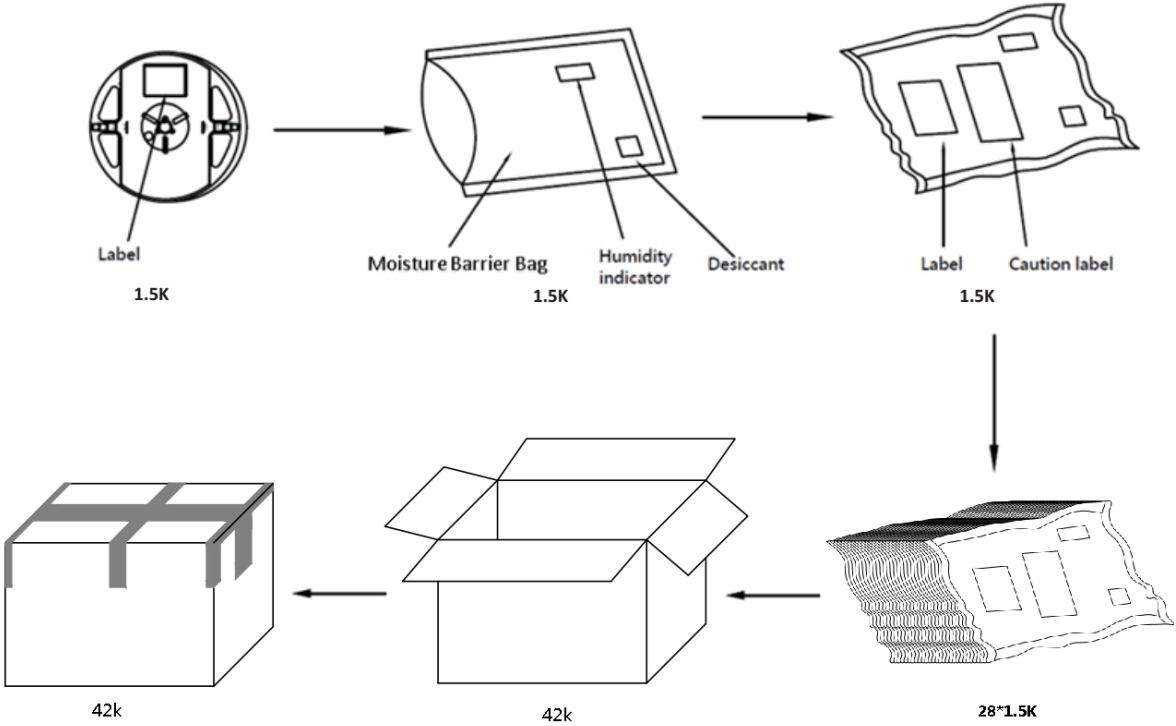

Note for Figure 16:
1. Drawings are not to scale.

Design Resources

Please contact your Bridgelux sales representative for assistance.

Precautions

CAUTION: CHEMICAL EXPOSURE HAZARD

Exposure to some chemicals commonly used in luminaire manufacturing and assembly can cause damage to the LED emitter. Please consult Bridgelux Application Note AN51 for additional information.

CAUTION: EYE SAFETY

Eye safety classification for the use of Bridgelux SMD LED emitter is in accordance with IEC specification EN62471: Photobiological Safety of Lamps and Lamp Systems. SMD LED emitters are classified as Risk Group 2 when operated at or below the maximum drive current. Please use appropriate precautions. It is important that employees working with LEDs are trained to use them safely.

CAUTION: RISK OF BURN

Do not touch the SMD LED emitter during operation. Allow the emitter to cool for a sufficient period of time before handling. The SMD LED emitter may reach elevated temperatures such that could burn skin when touched.

CAUTION

CONTACT WITH LIGHT EMITTING SURFACE (LES)

Avoid any contact with the LES. Do not touch the LES of the emitter or apply stress to the LES (yellow phosphor resin area). Contact may cause damage to the emitter

Optics and reflectors must not be mounted in contact with the LES (yellow phosphor resin area).

Disclaimers

MINOR PRODUCT CHANGE POLICY

The rigorous qualification testing on products offered by Bridgelux provides performance assurance. Slight cosmetic changes that do not affect form, fit, or function may occur as Bridgelux continues product optimization.

STANDARD TEST CONDITIONS

Unless otherwise stated, LED emitter testing is performed at the nominal drive current.

About Bridgelux: Bridging Light and Life™

At Bridgelux, we help companies, industries and people experience the power and possibility of light. Since 2002, we've designed LED solutions that are high performing, energy efficient, cost effective and easy to integrate. Our focus is on light's impact on human behavior, delivering products that create better environments, experiences and returns—both experiential and financial. And our patented technology drives new platforms for commercial and industrial luminaires.

For more information about the company, please visit
bridgelux.com
twitter.com/Bridgelux
facebook.com/Bridgelux
youtube.com/user/Bridgelux
https://www.linkedin.com/company/bridgelux-inc-_2
WeChat ID: BridgeluxInChina



46410 Fremont Boulevard
Fremont, CA 94538, USA
Tel (925) 583-8400
www.bridgelux.com

© 2023 Bridgelux, Inc. All rights reserved 2023. Product specifications are subject to change without notice. Bridgelux and the Bridgelux stylized logo design are registered trademarks of Bridgelux, Inc. All other trademarks are the property of their respective owners.