



Bridgelux® DriveLux-C3 3CCT 13mm Engine (Casambi) AC Inputs Light Engine (US)

Product Data Sheet DS1329

Product Feature Map

Bridgelux's Drivelux-C3 light engine revolutionizes everything. Bridgelux's global expertise in LEDs and driver has led to a significant breakthrough in lighting technology – integrating the AC-DC driver directly into the light engine, ensuring the highest quality of light. Crucially, Drivelux-C3 provides comprehensive cost reductions, from the expense, size, and manufacturing complexity of fixtures with traditional external drivers to inventory SKU reduction – aligning performance, control, and cost to meet every requirement.



Product Nomenclature

The part number designation for Bridgelux Drivelux-C3 Light Engine is explained as follows:

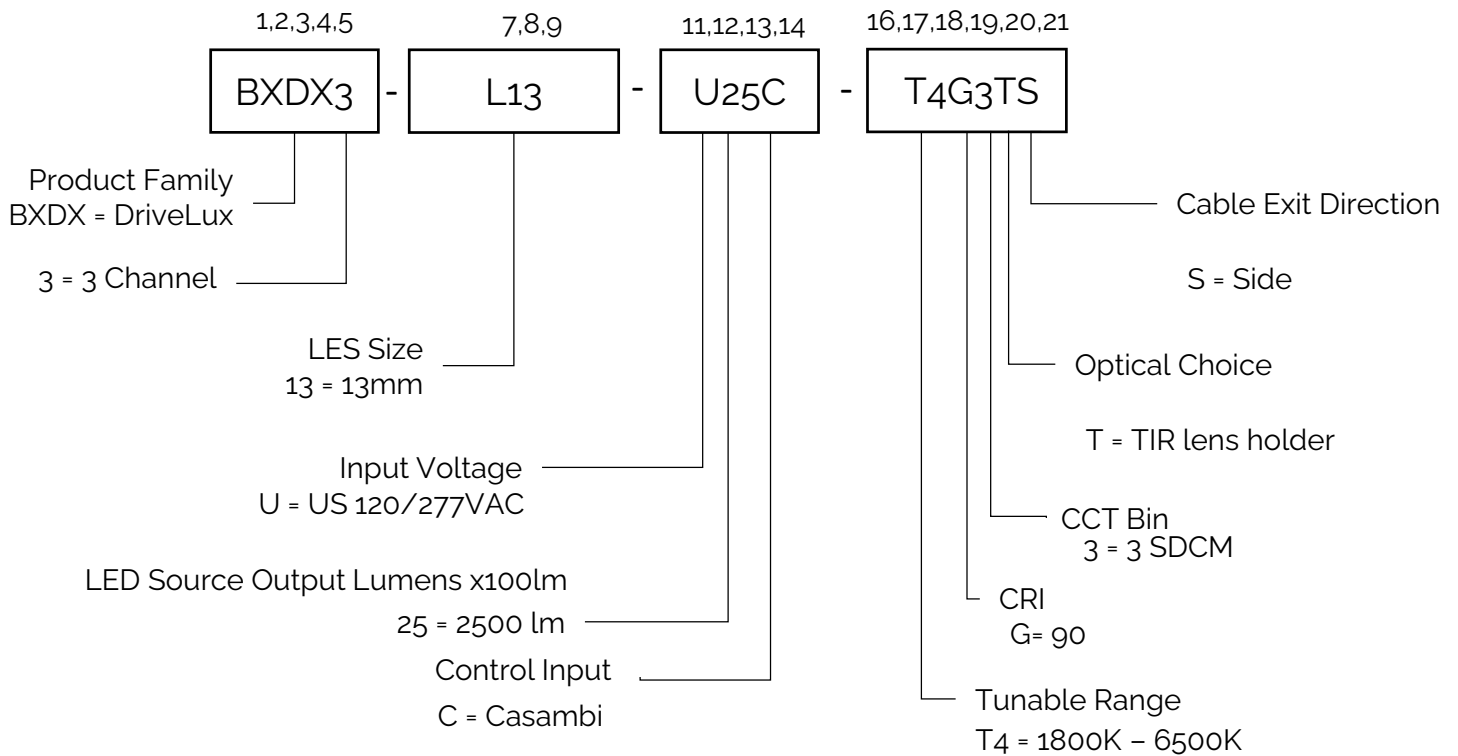

Product Selection Guide

Table 1: Product Selection Guide (examples)

Part Number	Configuration
BXDX3-L13-E25C-T4G3T ¹ S ²	120/277VAC, 13mm, 2500lm, CRI90, 3 SDCM, Casambi

1 Optical Choice:

- T = TIR Lens Holder

2 Cable Exit Direction:

- S = Side

Table 2: AC Input Power Cable (Ordered Separately)

Part Number	Configuration
BXDX-AC-NA400	2-wire AC Input Power Cable, Black/White, 400mm
BXDX-AC-NA100	2-wire AC Input Power Cable, Black/White, 100mm
BXDX-AC-NA413-QD	2-wire AC Input Power Cable, Black/White, 413mm, with quick disconnect
BXDX-AC-NA400-QDFL	2-wire AC Input Power Cable, Black/White, 400mm, with quick disconnect and flying leads

Electrical Characteristics

Table 3: Electrical Characteristics

Parameter	Unit	Specification
Nominal voltage	V	120 / 277 VAC
Nominal frequency	Hz	50 / 60 Hz
AC voltage range	V	108 – 305 Vac
Input current (max)	A	< 0.20 A (@ 120Vac) < 0.09 A (@ 277Vac)
Input Power (Typ.)	W	24.0 W
THD	%	< 20% (@ 120Vac, Dimming 100% - 40%) < 20% (@ 277Vac, Dimming 100% - 40%)
Power factor	-	> 0.9 (@ 120Vac, Dimming 100%) > 0.9 (@ 277Vac, Dimming 100%)
Inrush current	A	Meet NEMA-410 requirements (@25° C)
Standby Power	mW	< 500mW (@ 230Vac)
Control		Casambi
Flicker		Pst LM ≤ 1 SVM ≤ 0.4
Start-up Time	s	< 0.5 s

Table 5: Photometric Characteristics (Light Engine without Diffuser – LED temperature = 65°C)

CCT [K]	Input Power [W]	Lumens [lm]	CRI min.	Rg min.	Lm/W	Remarks
1800K	13.4	1067	88	31	79.6	
2200K	18.0	1653	94	55	91.8	
2700K	23.3	2390	95	68	102.6	
3000K	23.9	2597	94	72	108.7	
3500K	23.5	2668	94	76	113.5	
4000K	23.5	2736	93	75	116.4	
5000K	23.7	2821	90	65	119	
5700K	23.7	2793	90	66	117.8	
6500K	23.2	2695	90	65	116.2	

Photometric Characteristics

Figure 1: Typical Color Spectrum

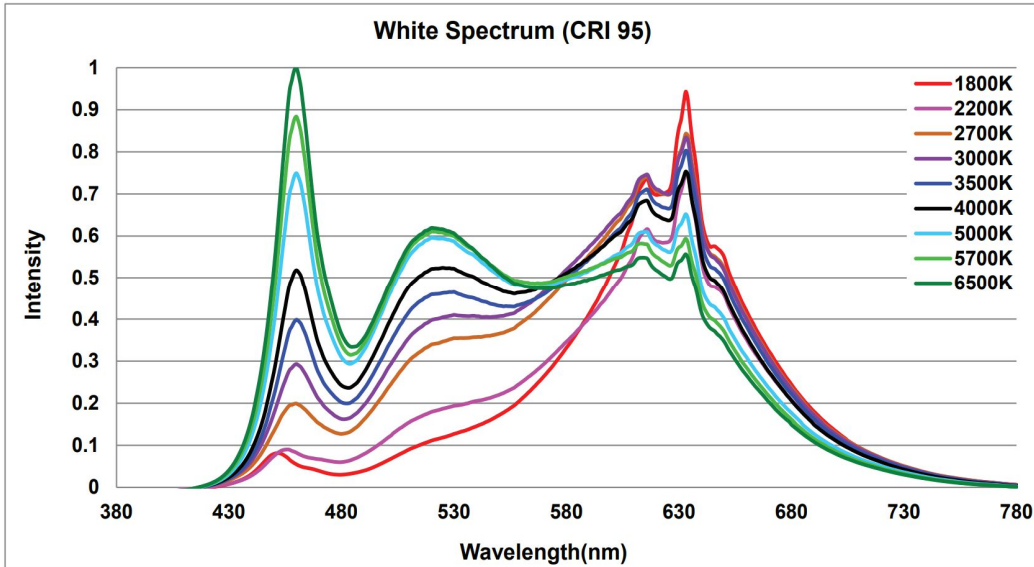
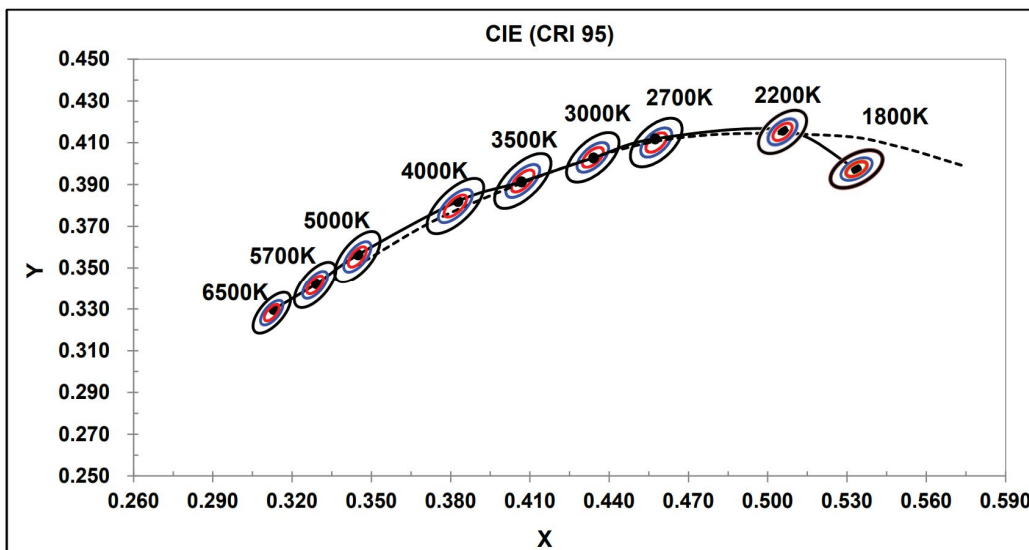

Figure 2: White Test Bins in xy Color Space



Electrical Characteristics

Figure 4: Power Factor vs Output Lumens

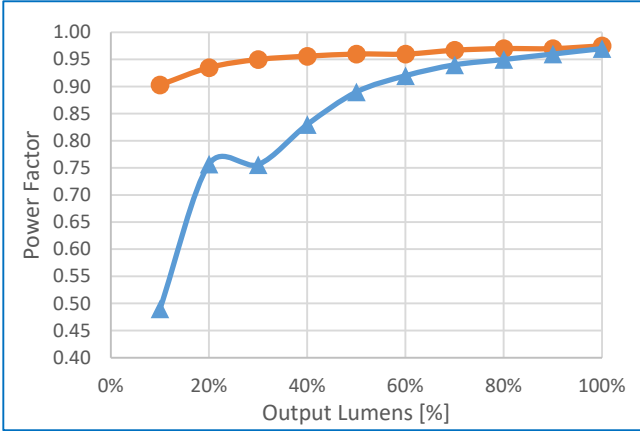

Figure 5: THDi vs Output Lumens

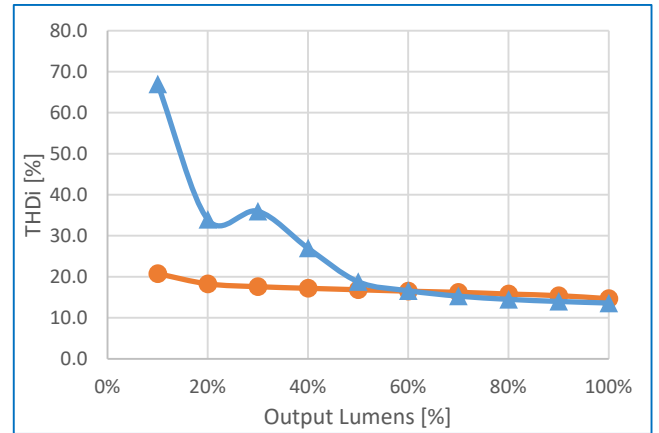

Figure 6: Input Power vs Output Lumens

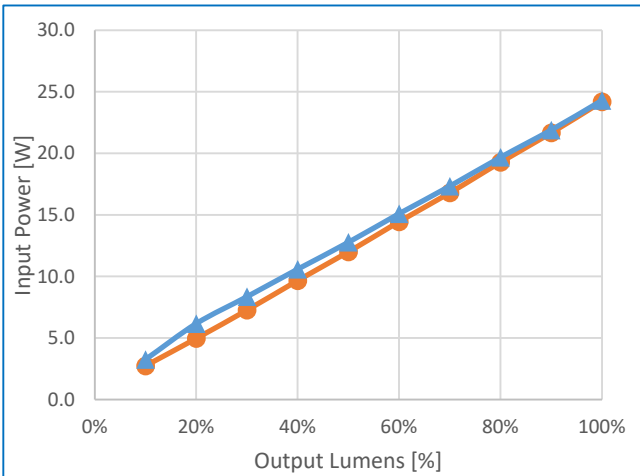

Figure 7: Output Lumens vs CCT

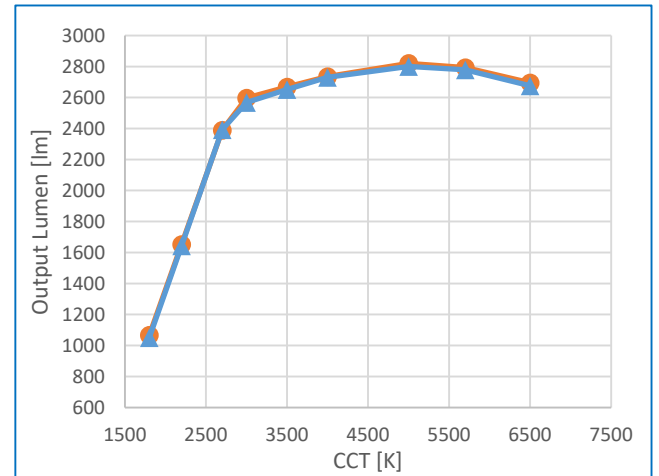
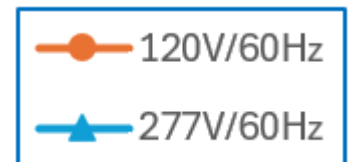
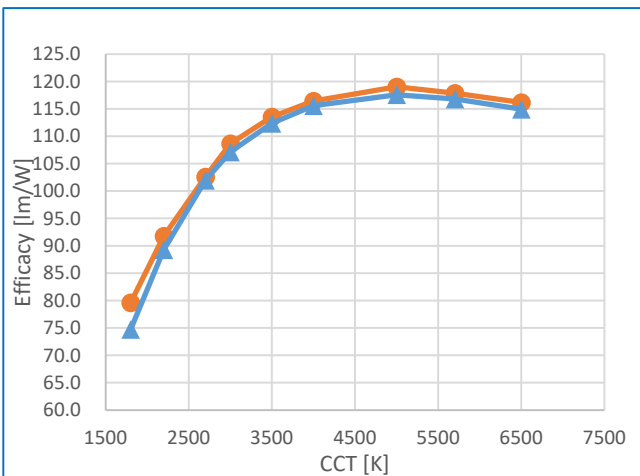

Figure 8: Efficacy vs CCT



Mechanical Characteristics

Table 5: Driver Mechanical Characteristics

Characteristics	Specification
Dimensions	Ø50 x 18.5 mm
Lighting Emitting Surface (LES)	10 mm
Weight	45 g

Figure 9: Mechanical Drawing (Side Cable Models)

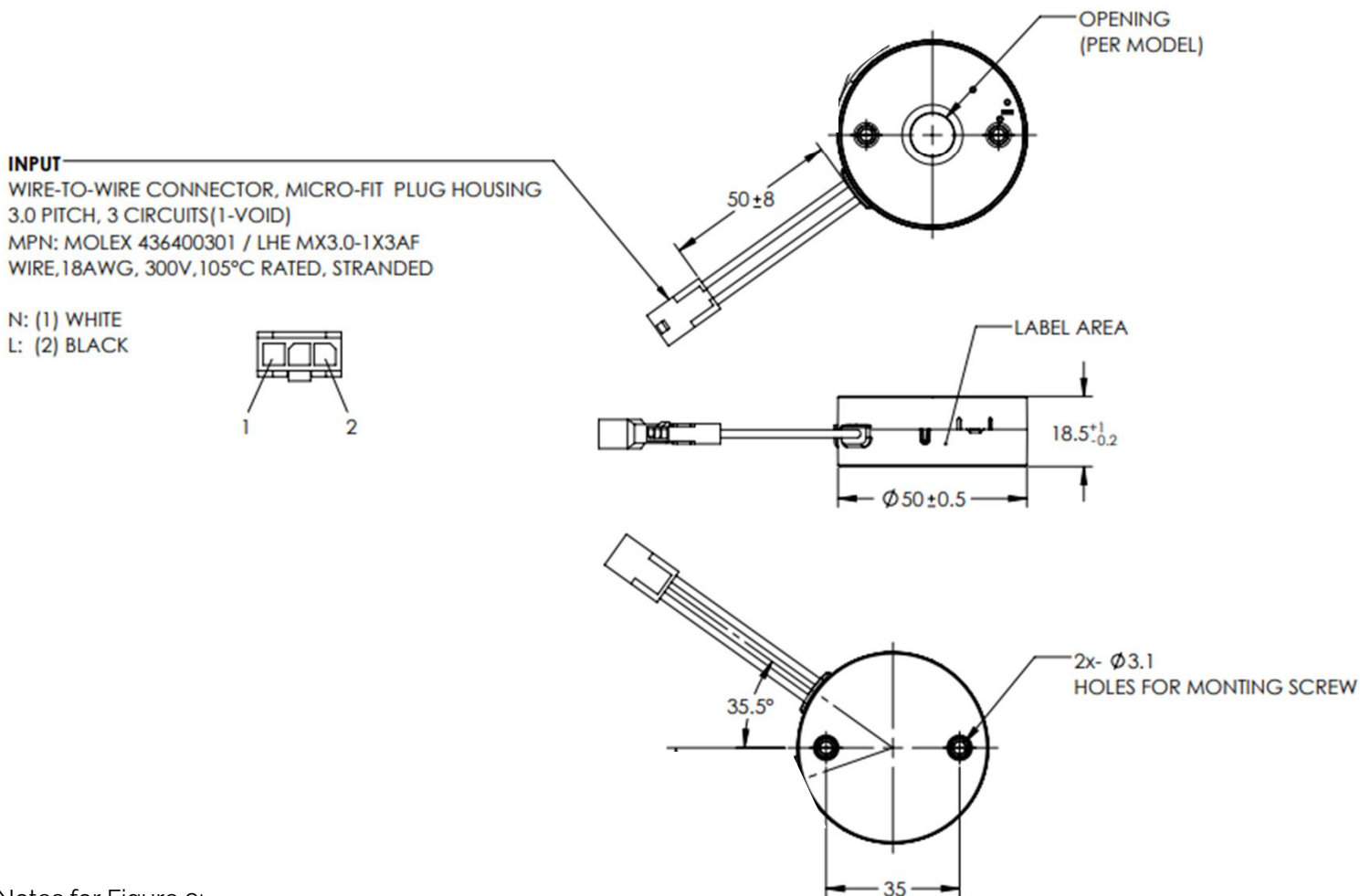

Notes for Figure 9:

1. Drawing dimensions are in millimeters
2. Unless otherwise specified, all linear tolerances are +/-1.0mm

Optical Accessories of the Light Engine

The Light Engine (LE) can order with the optical TIR lens holder. This holder can easily install various optics lens best for smooth color mixing.

Detail lens offering, can be referred to Bridgelux Website.



Thrive™ F90™ RGBW Component & Module ▾ Drivers ▾ Holders & Optics ▾ Power Devices ▾

Home > OPTICS

OPTICS

We've taken in your feedback and are thrilled to unveil the Bridgelux Integrated Solution. This solution includes Non-soldering Holders, Kirin Optics, and Drives, all designed to work together in harmony. The Optics, which are an essential part of this solution, come with a variety of beam angles, namely 15°, 24°, 36°, and 50°. Plus, they're available in different diameters, namely 35mm, 45mm, 55mm, up to 65mm. This variety ensures you find the perfect fit for your needs. What makes Bridgelux Optics even more special is their compatibility with our solder-free COB array holders, providing a smooth user experience. Our turn & lock design is a game-changer, it simplifies the adoption of our integrated lighting solution. In a nutshell, this design is a boon for manufacturers, lighting designers, and more, making the installation process easier than ever before. Additionally, we offer the opportunity for customization. We understand that needs can vary, so we're open to creating personalized solutions as per your specific requests. Customized solutions are available per customer request.

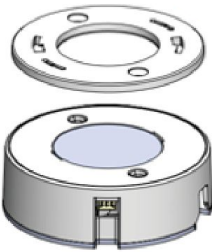

Product Family	Product	Data sheet	Doc Number	Diameter (mm)	Beam angle	Max LES (mm)	Material
BXHK	BXHK-MN-5024-xx-D09		DS1346	ø50, 24H	14, 24, 36, 50	9	PC
BXHK	BXHK-MN-5525-xx-D09		DS1347	ø55, 25H	14, 24, 36, 50	9	PC
BXHK	BXHK-MN-6230-xx-D09		DS1348	ø62, 30H	14, 24, 36, 50	9	PC
BXHK	BXHK-MN-6832-xx-D09		DS1349	ø68, 32H	14, 24, 36, 50	9	PC
BXHK	BXHK-DK-5024-xx-D09		DS1342	ø50, 24H	14, 24, 36, 50	9	PC
BXHK	BXHK-DK-5525-xx-D09		DS1343	ø55, 25H	14, 24, 36, 50	9	PC
BXHK	BXHK-DK-6230-xx-D09		DS1344	ø62, 30H	14, 24, 36, 50	9	PC
BXHK	BXHK-DK-6832-xx-D09		DS1345	ø68, 32H	14, 24, 36, 50	9	PC

Thermal Management of the Light Engine

Check the heat sink's temperature (T_c) with the Light Engine installed in the fixture under similar conditions to its final use. Aim for a T_c below 80°C .

The Light Engine has a safety feature that reduces power to the LEDs if T_c reaches 90°C .

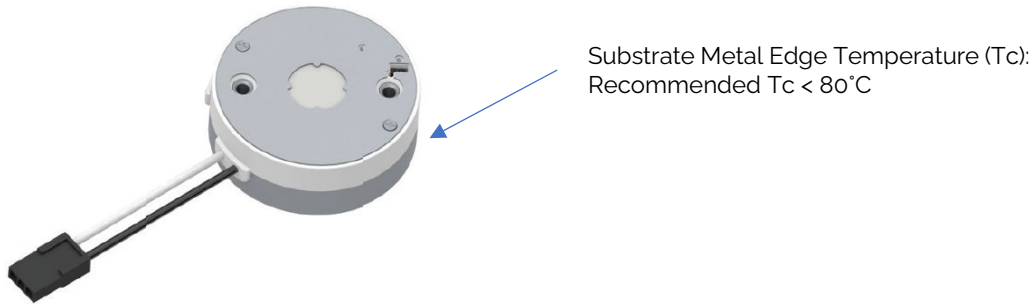

The Light Engine (LE) needs an external heat sink to maintain proper LED temperature. It has an aluminum base for efficient heat transfer, allowing simple heat sink designs. Several recommended heat sinks are listed with their performance at different Lumen outputs.

The LE can be installed in various fixtures, but solid contact with the heat sink and a thermally conductive material (at least $10 \text{ W}/(\text{m}^2\text{K})$) are crucial. Internal tests used an extruded heat sink. Proper airflow to the heat sink is essential to avoid overheating. The fixture's thermal design must keep the engine's base at the recommended temperature.

IMPORTANT: Heat sinks are usually tested in free air at 25°C . In insulated can fixtures, the LE might overheat. Test the heat sink in actual conditions for the desired application

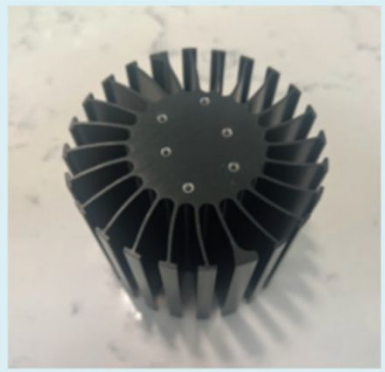
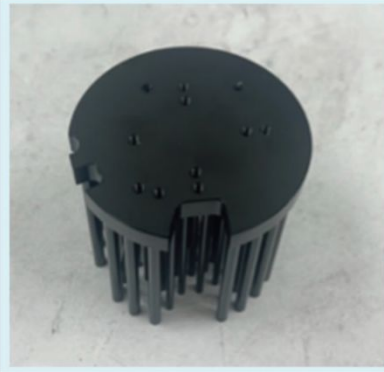
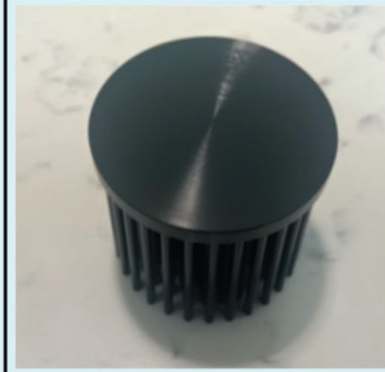
Manufacturer	Mechatronix	Mechatronix	Mechatronix
Model	GH36D 9980-B	LPF67A68-8-B	LPF70A50-5-B
			
	GH36D 9980-B, 120 Vac, Rev. X04, 4000K CCT	LPF67A68-8-B, 120 Vac, Rev. X04, 4000K CCT	LPF70A50-5-B, 120 Vac, Rev. X04, 4000K CCT
Light Engine Output (Lumen)	Ts at Ta of 40°C		Ts at Ta of 40°C
850			
1000			69.1
1250			74.5
1500			79.9
2000			91.5
2500 (Max)	64.9	85.3	97.4

Cable Assemblies (AC Input Power Cable)

Table 6: AC Input Cables 1

Part Number	Configuration
BXDX-AC-NA400	2-wire AC Input Power Cable, Black/White, 400mm
BXDX-AC-NA100	2-wire AC Input Power Cable, Black/White, 100mm

Item No.	Part No. (UL)	Wire Description	Wire Color	Input
3	UL 1430	Wire Stranded Tinned 18 AWG (Pin-1)	White	Neutral
4	UL 1430	Wire Stranded Tinned 18 AWG (Pin-3)	Black	Line

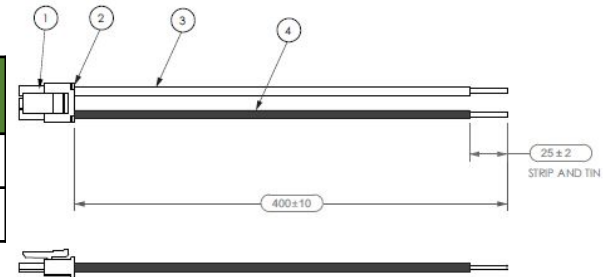
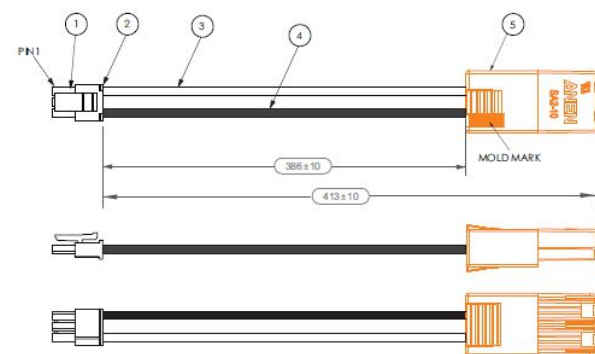

Table 7: AC Input Cables 2

Part Number	Configuration
BXDX-AC-NA413-QD	2-wire AC Input Power Cable, Black/White, 413mm, with quick disconnect
BXDX-AC-NA400-QDFL	2-wire AC Input Power Cable, Black/White, 400mm, with quick disconnect and flying leads

Item No.	Part No. (UL)	Wire Description	Wire Color	Input
3	UL 1430	Wire Stranded Tinned 18 AWG (Pin-1)	White	Neutral
4	UL 1430	Wire Stranded Tinned 18 AWG (Pin-3)	Black	Line
5	SA-2-10, Single	NBC ELECTRONIC 2-Pin Connector	Orange	N/A



Item No.	Part No. (UL)	Manufacturer	Description	QTY
1	3016H-1*03	ECI	Connector 3-Pin	1
2	3016P-L	ECI	Connector Crimp	2

Environmental and Regulatory Standards

Table 9: Environmental Conditions

Parameter	Specification
Ambient Operating Temperature	-20°C to +40°C <i>Light Engine can operate with $T_a > 40^\circ\text{C}$ by linearly de-rating the output lumen by 2.5%/°C (from 40°C - 60°C)</i>
Max. Case Temperature Tc	+90°C (max)
Humidity Rating	Maximum 95% Relative Humidity, non condensing
Storage Temperature	-40°C to + 85°C
Acoustic Noise	< 24 dBA (measured from 1M w/o/dimmer)
Expected Lifetime	50,000 hours (Tc < 80°C)
Working Locations	Suitable for dry and damp locations
Warranty	5 Years (Tc < 80°C)

Table 10: Regulatory Approvals and Compliance

Specification	Reference Standard	Condition
Conducted and Radiated EMI	FCC Title 47 Part 15B	Class B at 120VAC, Class A at 277VAC
Voltage Fluctuations & Flicker	IEC 61000-3-3	
ESD (Electrostatic Discharge)	IEC 61547:2009 Section 5.2 Test des.: IEC 61000-4-2	6 kV contact discharge, 8 kV air discharge, level 3
Radiated Immunity	IEC 61000-4-3	3 V/m, 80-1000 MHz, 80% modulated @ 3 meters, Level 2
Electrical Fast Transient	IEC 61547 Section 5.5 Test des.: IEC 61000-4-4	± 2KV on AC power port for 1minute, ± 1KV on signal/control lines
Surge Protection	IEC 61547 Section 5.7 Test des.: IEC 61000-4-5 or ANSI/IEEE C62.41-2002	± 2KV line to line / ± 2KV line to earth on AC power ports.
	ANSI/IEEE C62.41.1-2002	2.5kV Ring Wave
Conducted Immunity	IEC 61000-4-3	3V, 0.15-80 MHz, 80% modulated, Level 2
Voltage Dips	IEC 61547 Section 5.8, 5.9 Test des.: IEC 61000-4-11	>95% dip, .5 period; 30% dip, 25 periods; 95% reduction, 250 periods

Note: Unless otherwise specified, all the above parameters are measured at ambient temperature of 25°C and rated voltage.

Regulatory Standards (continued)

Table 11: Safety Agency Approvals

Specification	Reference Standard	Condition
UL / cUL	UL8750, CAN/CSA-C22.2 No. 250.13	UL Recognized, Class 2

Table 12: Protection

Specification	Reference Standard	Condition
Over Voltage Protection (OVP)	YES	Automatic recovery
OLP tolerance	100 – 110%	
Over Temperature Protection (OTP)	YES	Gradually reduce output power when $T_c < 85^\circ\text{C}$ Automatic recovery
Output Short-Circuit Protection (SCP)	YES	Automatic recovery



Design Resources

Application Notes

Please contact your Bridgelux sales representative for assistance on obtaining application support when designing with the Bridgelux Drivelux-C3 Light Engine. For a list of available resources, visit www.bridgelux.com.

Precautions

CAUTION: PRODUCT HANDLING

Handle the Drivelux-C3 Light Engine with care to prevent any damage from mechanical shock
It is recommended to handle this driver in a static-free environment
Do not open or disassemble the product
To maintain product warranty, the installer is responsible for ensuring that the driver's operating conditions do not exceed the maximum conditions stated within this data sheet

CAUTION: ELECTRIC SHOCK

Be aware of the possibility of an electric shock hazard which can result in serious injury or death.
Disconnect power before servicing or installing this device.

Disclaimers

MINOR PRODUCT CHANGE POLICY

The rigorous qualification testing on products offered by Bridgelux provides performance assurance. Slight cosmetic changes that do not affect form, fit, or function may occur as Bridgelux continues product optimization.

About Bridgelux: Bridging Light and Life™

At Bridgelux, we help companies, industries and people experience the power and possibility of light. Since 2002, we've designed LED solutions that are high performing, energy efficient, cost effective and easy to integrate. Our focus is on light's impact on human behavior, delivering products that create better environments, experiences and returns—both experiential and financial. And our patented technology drives new platforms for commercial and industrial luminaires.

For more information about the company, please visit

bridgelux.com

twitter.com/Bridgelux

facebook.com/Bridgelux

youtube.com/user/Bridgelux

linkedin.com/company/bridgelux

WeChat ID: BridgeluxInChina



46410 Fremont Blvd

Fremont, CA 94538 USA

Tel (925) 583-8400

www.bridgelux.com