



Bridgelux® Vesta-C4 Quad Channel 42W (Casambi) Brick Driver

Product Data Sheet DS1297

Product Feature Map

Bridgelux Vesta-C4 (Casambi) Quad Channel 42W Driver provides dynamic constant current output for LED modules and arrays. This Driver interoperates with Casambi control lighting systems and protocols and allows for simple integration of Bridgelux's RGBW and 3CCT White Arrays and Linear modules. Please visit www.bridgelux.com for more information.

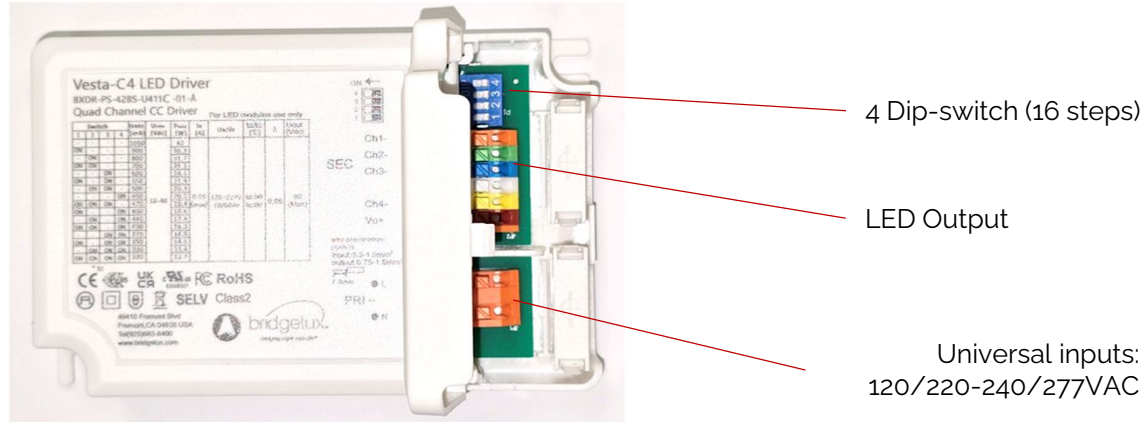

Product Nomenclature

The part number designation for Bridgelux Vesta-C4 (Casambi) Quad Channel 42W Driver is explained as follows:

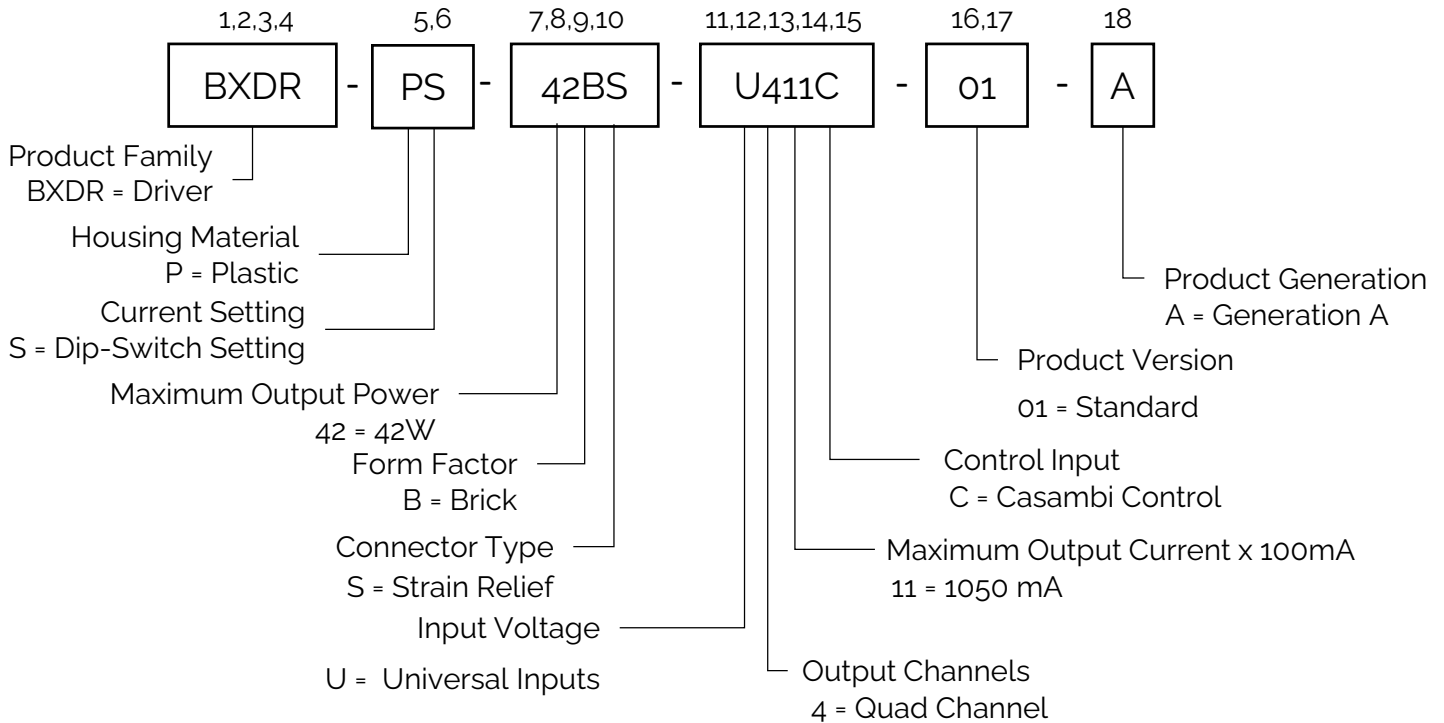
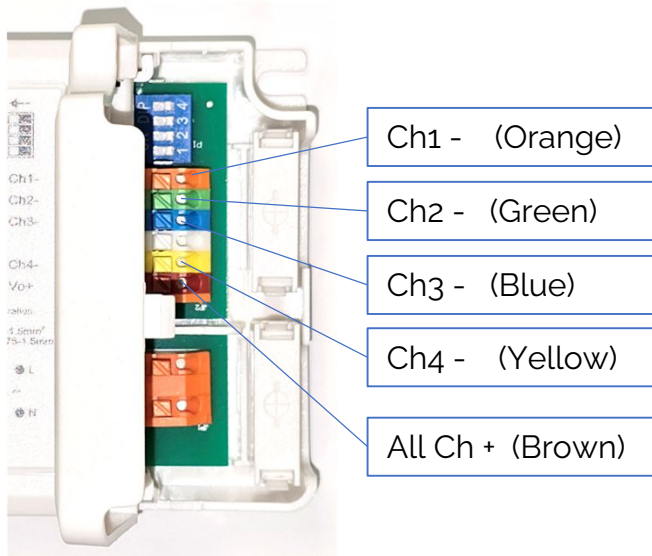

Table 1: **Product Selection Guide**

Part Number	Configuration
BXDR-PS-42BS-U411C-01-A	Brick with Strain Relief, US 120/277VAC

Wiring and setup instructions



Bridgelux Vesta-C4 driver can power up various Bridgelux 4 Channels LEDs (RGBW series). Below table provides some examples of the driver channel mapping to different LEDs channels (further instructions please contacts Bridgelux).

Driver Channel	SMD RGBW (CRI 95)	SMD 3CCT (CRI 90)	SMD 3CCT (CRI 97)
1	Red	1	1
2	Green	1	2
3	Blue	2	3
4	White	3	3

Similar to hardware wiring (different configurations) , Bridgelux Vesta-C4 driver comes with different firmware for various LEDs control parameters.

After driver setup in Casambi apps, user can find the corresponding Casambi Fixture IDs.

Casambi Fixture IDs		
SMD RGBW (CRI 95)	SMD 3CCT (CRI 90)	SMD 3CCT (CRI 97)
TBC	TBC	TBC

Electrical Characteristics

Table 2: Input Electrical Characteristics

Parameter	Unit	Specification
Nominal voltage	V	120 / 220 – 240 / 277
Nominal frequency	Hz	50 / 60
AC voltage range	V	108 – 305
DC voltage range	V	NA
Nominal current (Max)	A	0.40A @120V
Power factor (Full load)	-	≥ 0.99 @ 120V ≥ 0.95 @ 230V ≥ 0.92 @ 277V
THD (Full load)	%	≤ 3% @ 120V ≤ 10% @ 230V ≤ 16% @ 277V
Efficiency (Full load)	%	≥ 88% @ 120V ≥ 88% @ 230V ≥ 87% @ 277V
NO load	W	≤ 0.5
Inrush current (Cold Start)	A pk	< 11.4A @ 120V input 25°C cold start at 100% conditions. For more details in the attached graph
Protection class	-	I, II

Table 3: Output Electrical Characteristics

Parameter	Unit	Specification
Nominal voltage range	V	18-40V
Maximum voltage(Open Circuit)	Vdc	≤ 59
Nominal current	mA	320 330 350 370 400 440 460 470 490 500 550 600 700 800 900 1050
Current accuracy	%	+/- 5
Dimming		Casambi (Wireless)
Dimming Range		10% - 100%
Current ripple LF < 2KHz	%	≤ 10
Pst LM	-	≤ 1.0
SVM	-	≤ 0.4
Maximum power	W	42
Galvanic isolation	-	SELV

Electrical Characteristics

Figure 1: Operating Window

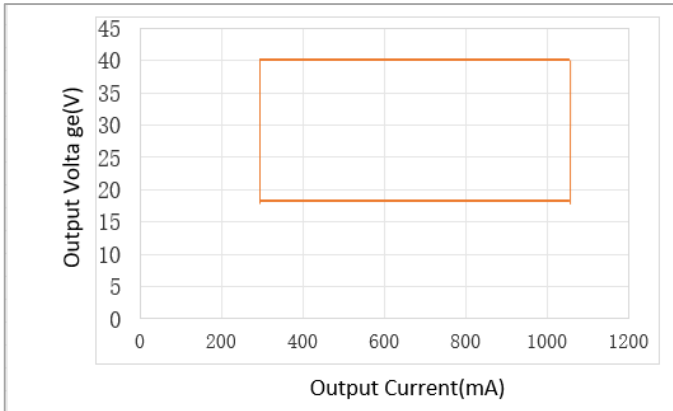

Figure 2: Power Factor vs. Output Power

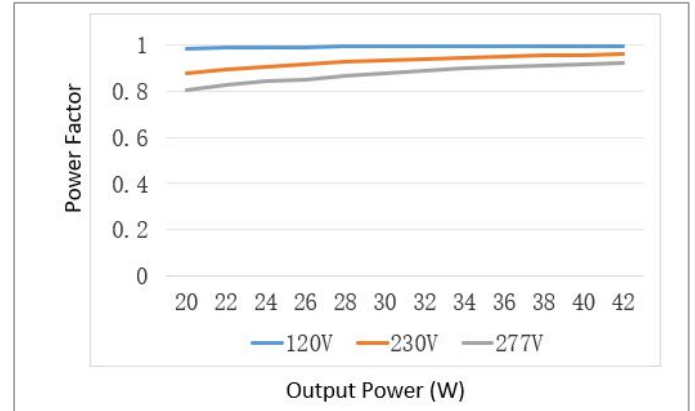

Figure 3: THD vs Output Power

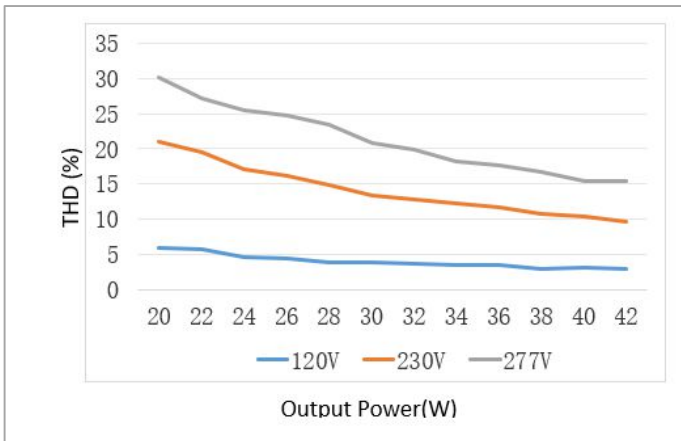
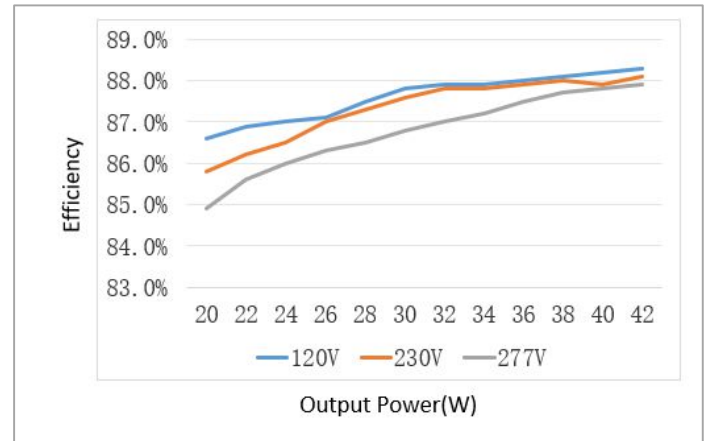
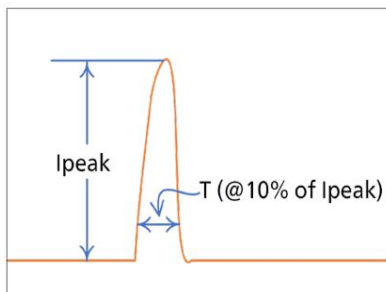

Figure 4: Efficiency vs Output Power



Inrush Current



Input Voltage	I_{peak} (A)	Twidth (Time @10% of I_{peak})
120VAC	11.4 A	43.6 μ s
230VAC	16.6 A	39.2 μ s
277VAC	20.2 A	38.4 μ s

Table 4: Estimated Maximum Number of Drivers per Miniature Circuit Breaker (MCB)

Input Voltage	B10	B13	B16	B20	B25	B32	C10	C13	C16	C20	C25	C32
120VAC	15	20	24	30	37	48	15	20	24	30	37	48
230VAC	28	36	45	56	70	90	28	36	45	56	70	90
277VAC	23	30	37	46	57	74	34	44	54	68	85	109

Mechanical Characteristics

Table 5: Product Selection Guide

Characteristics	Specification
Dimensions	123.9 mm (L) x 78.8 mm (W) x 30.0 mm (H)
Enclosure Materials	PC Plastic
Weight	176.8 g
Ingress Protection	IP20

Figure 5: Mechanical Drawing

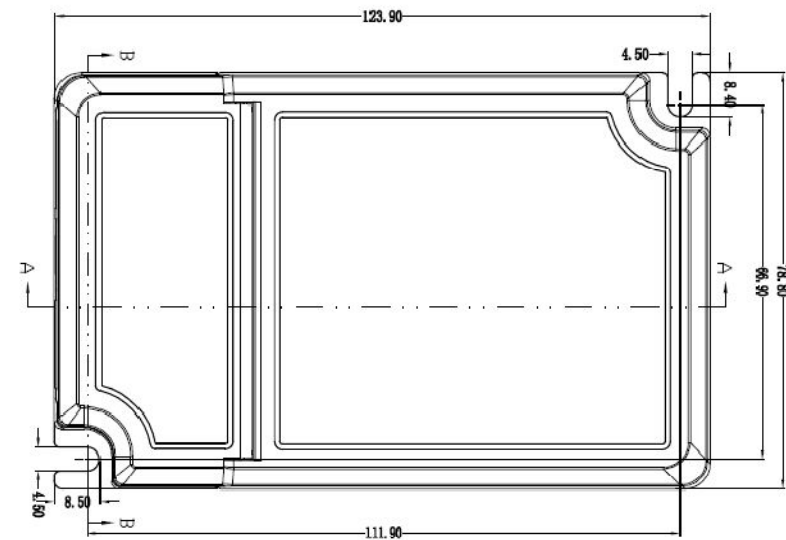

Notes for Figure 5:

1. Drawing dimensions are in millimeters
2. Unless otherwise specified, all linear tolerances are $\pm 1.0\text{mm}$.

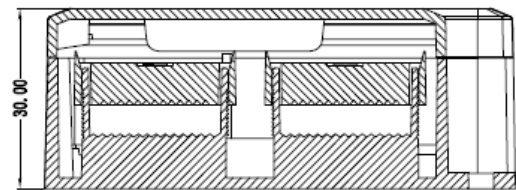
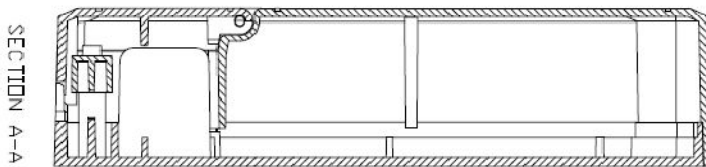

SECTION B-B

Wiring & Connections

Table 6: Wiring

	Specification item	Value
PRI	Cable cross-section	0.5 – 1.5 mm ² / AWG 20 – 15 0.75 – 1.5 mm ² / AWG 18 – 15 (with Strain Relief)
	Stripping	8 mm
SEC	Cable cross-section	0.5 – 1.5 mm ² / AWG 20 – 15 0.75 – 1.5 mm ² / AWG 18 – 15 (with Strain Relief)
	Stripping	8 mm

Notes for Table 6:

1. Unless otherwise specified, all linear tolerances are +/-1.0mm

DIP-switch operation instructions & operating window

Table 7: Dip-switch operation instructions & operating window

Dip-switch setting				U _{out}	I _{out}
1	2	3	4		
-	-	-	-	18 – 40V	1050 mA
ON	-	-	-	18 – 40V	900 mA
-	ON	-	-	18 – 40V	800 mA
ON	ON	-	-	18 – 40V	700 mA
-	-	ON	-	18 – 40V	600 mA
ON	-	ON	-	18 – 40V	550 mA
-	ON	ON	-	18 – 40V	500 mA
-	-	-	ON	18 – 40V	490 mA
ON	ON	ON	-	18 – 40V	470 mA
ON	-	-	ON	18 – 40V	460 mA
-	ON	-	ON	18 – 40V	440 mA
ON	ON	-	ON	18 – 40V	400 mA
-	-	ON	ON	18 – 40V	370 mA
ON	-	ON	ON	18 – 40V	350 mA
-	ON	ON	ON	18 – 40V	330 mA
ON	ON	ON	ON	18 – 40V	320 mA

Environmental and Regulatory Standards

Table 8: Environmental Conditions

Parameter	Specification
Ambient Operating Temperature	-20°C to + 50°C
Max. Case Temperature Tc	+80°C (max)
Humidity Rating	Maximum 90% Relative Humidity, non condensing
Storage Temperature	-40°C to + 80°C
Expected Lifetime	> 50,000 hours (Tc < 80°C)

Table 9: Regulatory Approvals and Compliance

Specification	Reference Standard	Condition
Conducted and Radiated EMI	US: FCC Title 47 Part 15B EU: EN 55015:2013 (CISPR 15:2013)	US: Class B at 120VAC, Class A at 277VAC
Harmonic Current Emissions	EN IEC 61000-3-2:2014	
Voltage Fluctuations & Flicker	IEC 61000-3-3:2013	
ESD (Electrostatic Discharge)	IEC 61547:2009 Section 5.2 Test des.: IEC 61000-4-2	4 kV contact discharge, 8 kV air discharge, level 3
Continuous Radiated Disturbance	IEC 61547:2009 Section 5.3 Test des.: IEC 61000-4-3	3 V/m, 80 - 1000 MHz, 80% modulated at distance of 3 meters
Electrical Fast Transient	IEC 61547:2009 Section 5.5 Test des.: IEC 61000-4-4	± 1 kV on AC power port for 1 minute,
Surge	IEC 61547 Section 5.7 Test des.: IEC 61000-4-5	± 1 kV (differential mode)
Continuous Conducted Disturbance	IEC 61547:2009 Section 5.6 Test des.: IEC 61000-4-6	3V, 0.15-80 MHz, 80% modulated, Level 2
Voltage Dips	IEC 61547 Section 5.8, 5.9 Test des.: IEC 61000-4-11	70% dip during 25 cycles @ 50Hz, 30 cycles @ 60Hz 0% dip during ½ cycles

Regulatory Standards (continued)

Table 10: Safety Agency Approvals

Specification	Reference Standard	Condition
UL / cUL	UL8750, CAN/CSA-C22.2 No. 250.13	pending
ENEC / CE / UKCA	EN 61347-1:2015, EN 61347-2-13:2014/A1:2017	pending

Table 11: Wireless Standards / Parameters

Specification	Reference Standard / Parameters	Condition
Work Mode	Wi-Fi: 802.11b/g BLE: Bluetooth 4.2	
RF Output Power	Wi-Fi: 20 dBm BLE: 8 dBm	
Work Frequency	Wi-Fi: 2.4 - 2.4835 GHz BLE: 2.4 - 2.4835 GHz	



Packaging

Table 12: Packaging Box Configuration

Parameters	Specification
Driver quantity	20 pcs
Outer dimensions	260 X 170 X 190 mm
Weight	4.8 kg

Design Resources

Application Notes

Please contact your Bridgelux sales representative for assistance on obtaining application support when designing with the Bridgelux Vesta-C4 Quad Channel Driver. For a list of available resources, visit www.bridgelux.com.

Precautions

CAUTION: PRODUCT HANDLING

Handle the Vesta-C4 Quad Channel Driver with care to prevent any damage from mechanical shock. It is recommended to handle this driver in a static-free environment. To maintain product warranty, the product must not be opened or disassembled and the installer must ensure that the driver's operating conditions do not exceed the maximum conditions stated within this data sheet.

CAUTION: PRODUCT INSTALLATION

Incorrect installation of the Vesta-C4 Quad Channel Driver can cause irreparable damage to the driver, connected LEDs. Pay attention when connecting the LED load and observe the correct polarity of the output terminals as specified in this data sheet and on the driver label. Hot plug-in or secondary switching of LEDs is not permitted and may cause a very high current to the LEDs.

CAUTION: ELECTRIC SHOCK

Be aware of the possibility of an electric shock hazard which can result in serious injury or death. Disconnect power before servicing or installing this device.

Disclaimers

MINOR PRODUCT CHANGE POLICY

The rigorous qualification testing on products offered by Bridgelux provides performance assurance. Slight cosmetic changes that do not affect form, fit, or function may occur as Bridgelux continues product optimization.

About Bridgelux: Bridging Light and Life™

At Bridgelux, we help companies, industries and people experience the power and possibility of light. Since 2002, we've designed LED solutions that are high performing, energy efficient, cost effective and easy to integrate. Our focus is on light's impact on human behavior, delivering products that create better environments, experiences and returns—both experiential and financial. And our patented technology drives new platforms for commercial and industrial luminaires.

For more information about the company, please visit

bridgelux.com

twitter.com/Bridgelux

facebook.com/Bridgelux

youtube.com/user/Bridgelux

linkedin.com/company/bridgelux

WeChat ID: BridgeluxInChina



46410 Fremont Blvd

Fremont, CA 94538 USA

Tel (925) 583-8400

www.bridgelux.com