



Bridgelux® DriveLux-X4 RGBW 13mm Engine (DMX) AC Inputs Light Engine

Product Data Sheet DS1285

Product Feature Map

Bridgelux's DriveLux-X4 light engine revolutionizes everything. Bridgelux's global expertise in LEDs and driver has led to a significant breakthrough in lighting technology – integrating the AC-DC driver directly into the light engine, ensuring the highest quality of light. Crucially, DriveLux-X4 provides comprehensive cost reductions, from the expense, size, and manufacturing complexity of fixtures with traditional external drivers to inventory SKU reduction – aligning performance, control, and cost to meet every requirement.



Product Nomenclature

The part number designation for Bridgelux DriveLux-X4 Light Engine is explained as follows:

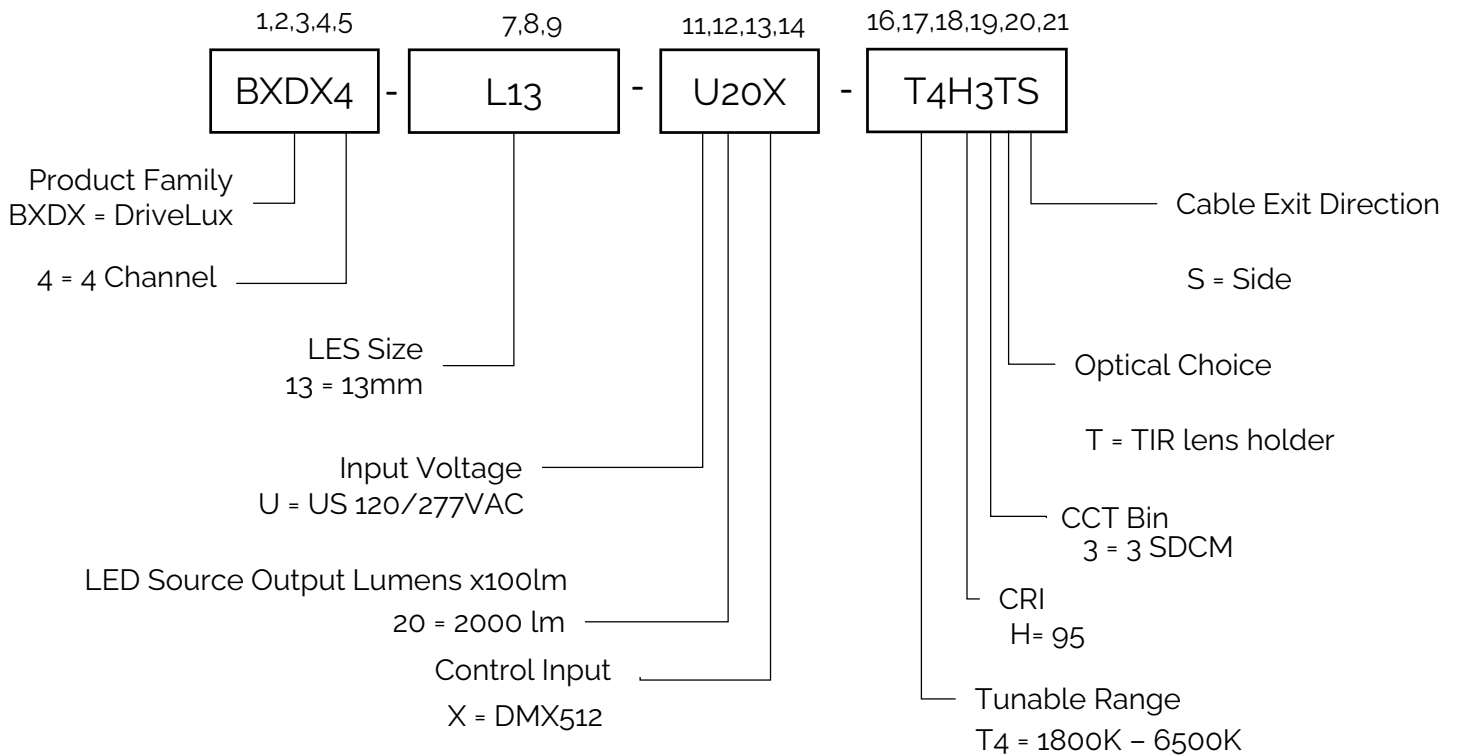

Product Selection Guide

Table 1: Product Selection Guide (examples)

Part Number	Configuration
BXDX4-L13-U20X-T4H3D ¹ S ²	120/277VAC, 13mm, 2000lm, CRI95, 3 SDCM, DMX 512

1 Optical Choice:

- T = TIR Lens Holder

2 Cable Exit Direction:

- S = Side

Table 2: AC Input Power Cable (Ordered Separately)

Part Number	Configuration
BXDX-AC-NA400	2-wire AC Input Power Cable, Black/White, 400mm, for North America
BXDX-AC-NA100	2-wire AC Input Power Cable, Black/White, 100mm, for North America
BXDX-AC-NA413-QD	2-wire AC Input Power Cable, Black/White, 413mm, for North America, with quick disconnect
BXDX-AC-NA400-QDFL	2-wire AC Input Power Cable, Black/White, 400mm, for North America, with quick disconnect and flying leads

Table 3: DMX Control Cable (Ordered Separately)

Part Number	Configuration
BXDX-DC3W-NA100	3-wire DC Control Cable, Violet/Orange/Pink, 100mm, for North America

Electrical Characteristics

Table 4: Electrical Characteristics

Parameter	Unit	Specification
Nominal voltage	V	120 / 277 VAC
Nominal frequency	Hz	50 / 60 Hz
AC voltage range	V	108 – 305 Vac
Input current (max)	A	< 0.185 A (@ 120Vac) < 0.085 A (@ 277Vac)
Input Power (Typ.)	W	22.0W
THD	%	< 20% (@ 120Vac, Dimming 100% - 40%) < 20% (@ 277Vac, Dimming 100% - 40%)
Power factor	-	> 0.9 (@ 120Vac, Dimming 100%) > 0.9 (@ 277Vac, Dimming 100%)
Inrush current	A	Meet NEMA-410 requirements (@25° C)
Standby Power	mW	< 500mW (@ 120Vac) < 1000mW (@ 277Vac)
Dimming Control		DMX 512
Flicker		Compliance with IEEE 1789-2015
Start-up Time	s	< 0.5 s

Table 5: Photometric Characteristics (Light Engine without Diffuser – LED temperature = 65°C)

CCT [K]	Input Power [W]	Lumens [lm]	CRI min.	R _g min.	Lm/W	Remarks
1800K	15.5	969	92.18	66	62.5	
2200K	21.0	1564	94.17	58	74.5	
2700K	20.6	1718	94.51	61	83.4	
3000K	20.8	1807	94.75	64	86.9	
3500K	21.0	1894	95.33	69	90.2	
4000K	21.0	1932	95.81	76	92.0	
5000K	21.87	2037	95.31	83	93.1	
5700K	21.3	1993	95.21	87	93.6	
6500K	20.7	1947	95.15	88	94.1	

DriveLux DX4-X RDM Personality Setting

DriveLux DX4-X comes with 6 personalities, it can be switched via DMX controller with RDM features:

Personality	DMX Ch 1	DMX Ch 2	DMX Ch 3	DMX Ch 4	DMX Ch 5	DMX Ch 6	DMX Ch 7	DMX Ch 8
	8 bit (0-255)	8 bit (0-255)	8 bit (0-255)	8 bit (0-255)	8 bit (0-255)	8 bit (0-255)	8 bit (0-255)	8 bit (0-255)
Color Tuning 4ch (8bit)	Intensity	CCT	Saturation	Hue	/	/	/	/
Color Tuning 4ch (16bit)	Intensity MSB	Intensity LSB	CCT MSB	CCT LSB	Saturation MSB	Saturation LSB	Hue MSB	HUE LSB
RGBW* 4ch (8bit)	Red	Green	Blue	White	/	/	/	/
RGBW* 4ch (16bit)	Red MSB	Red LSB	Green MSB	Green LSB	Blue MSB	Blue LSB	White MSB	White LSB
Halogen (Dim-To-Warm 1)	Intensity MSB	Intensity LSB	/	/	/	/	/	/
Incandescent (Dim-To-Warm 2)	Intensity MSB	Intensity LSB	/	/	/	/	/	/

MSB = Most Significant Bit
LSB = Least Significant Bit

Example 1: Personality = Color Tuning 4ch (8bit)

CCT [K] / Color	DMX manual setting			
	DMX 1	DMX 2	DMX 3	DMX 4
	Intensity	CCT	Saturation	Hue
1800	255	0	0	X
2200	255	22	0	X
2700	255	49	0	X
3000	255	65	0	X
4000	255	119	0	X
5000	255	174	0	X
5700	255	212	0	X
6500	255	255	0	X
Red	255	X	255	0
Amber	255	X	255	21
Yellow	255	X	255	43
Green	255	X	255	85
Cyan	255	X	255	128
Blue	255	X	255	170
Magenta	255	X	255	213
Red	255	X	255	255

Example 2: Personality = RGBW* 4ch (8bit)

CCT [K] / Color	DMX manual setting			
	DMX 1	DMX 2	DMX 3	DMX 4
	Red	Green	Blue	White
1800	232	4	0	82
2200	232	0	12	185
2700	184	40	42	236
3000	153	66	63	246
4000	104	137	132	245
5000	67	205	183	239
5700	53	223	221	235
6500	39	249	255	230
Red	255	0	0	0
Green	0	255	0	0
Blue	0	0	255	0
Yellow	170	85	0	0
Cyan	0	85	170	0
Magenta	85	0	170	0

"X" = Don't Care

Photometric Characteristics

Figure 1: Typical Color Spectrum

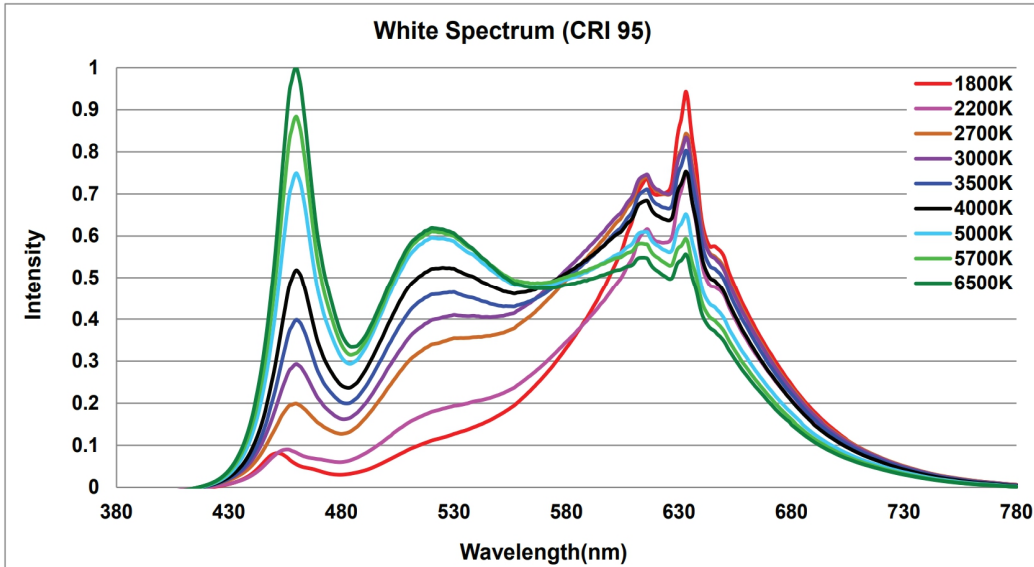

Figure 2: White Test Bins in xy Color Space

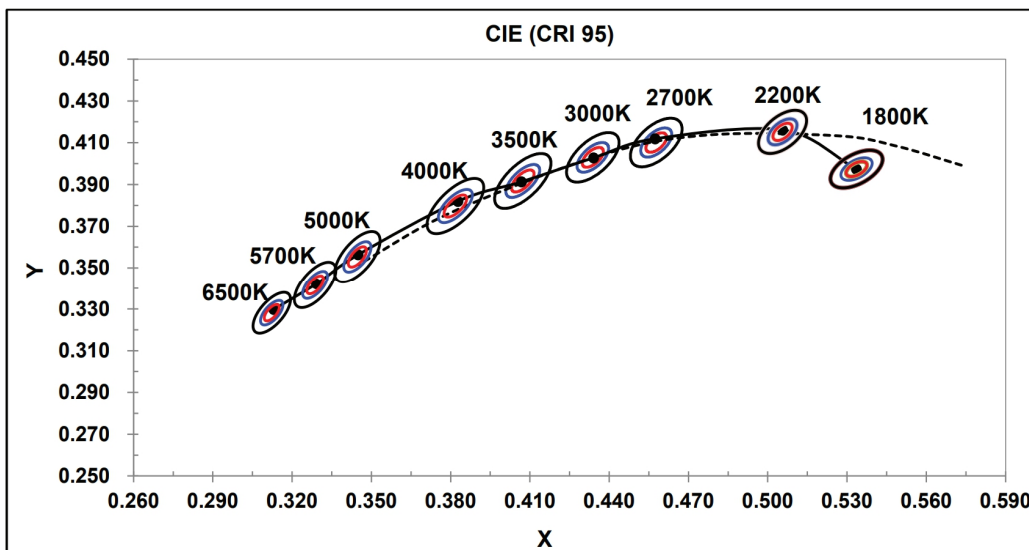
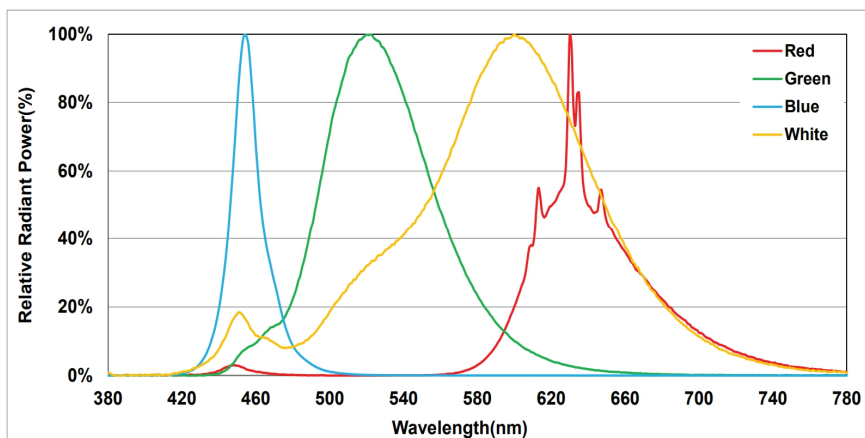

Table 3: Typical Color Spectrum (RGBW)



Electrical Characteristics

Figure 4: Power Factor vs Output Lumens

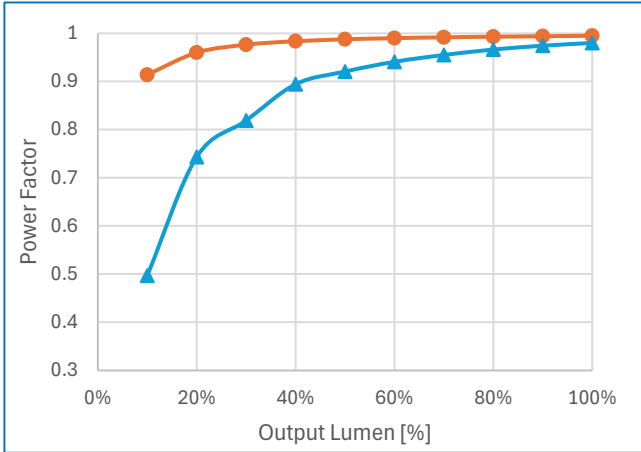

Figure 5: THDi vs Output Lumens

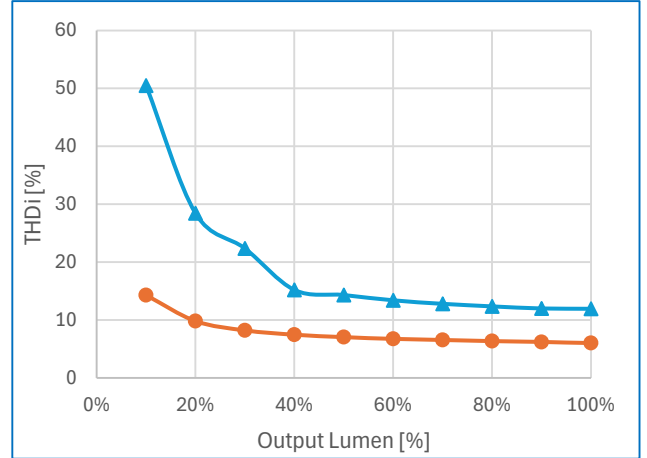

Figure 6: Input Current vs Output Lumens

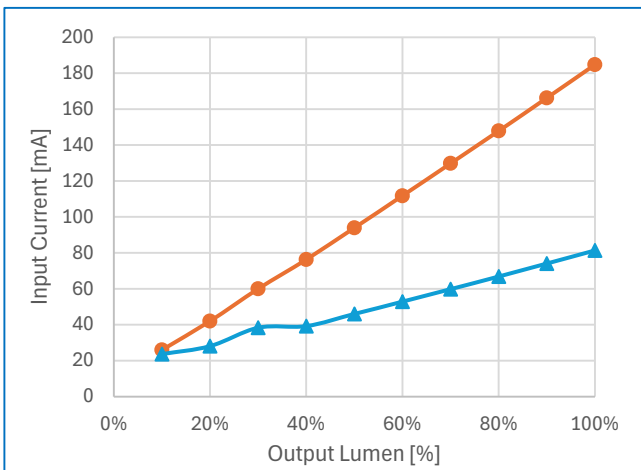
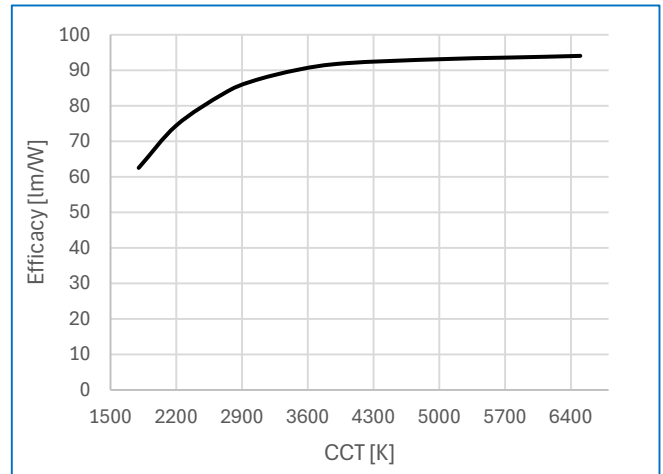

Figure 7: Efficacy vs CCT



Mechanical Characteristics

Table 5: Driver Mechanical Characteristics

Characteristics	Specification
Dimensions	Ø50 x 18.5 mm
Lighting Emitting Surface (LES)	13 mm
Weight	45 g

Figure 9: Mechanical Drawing (Side Cable Models)

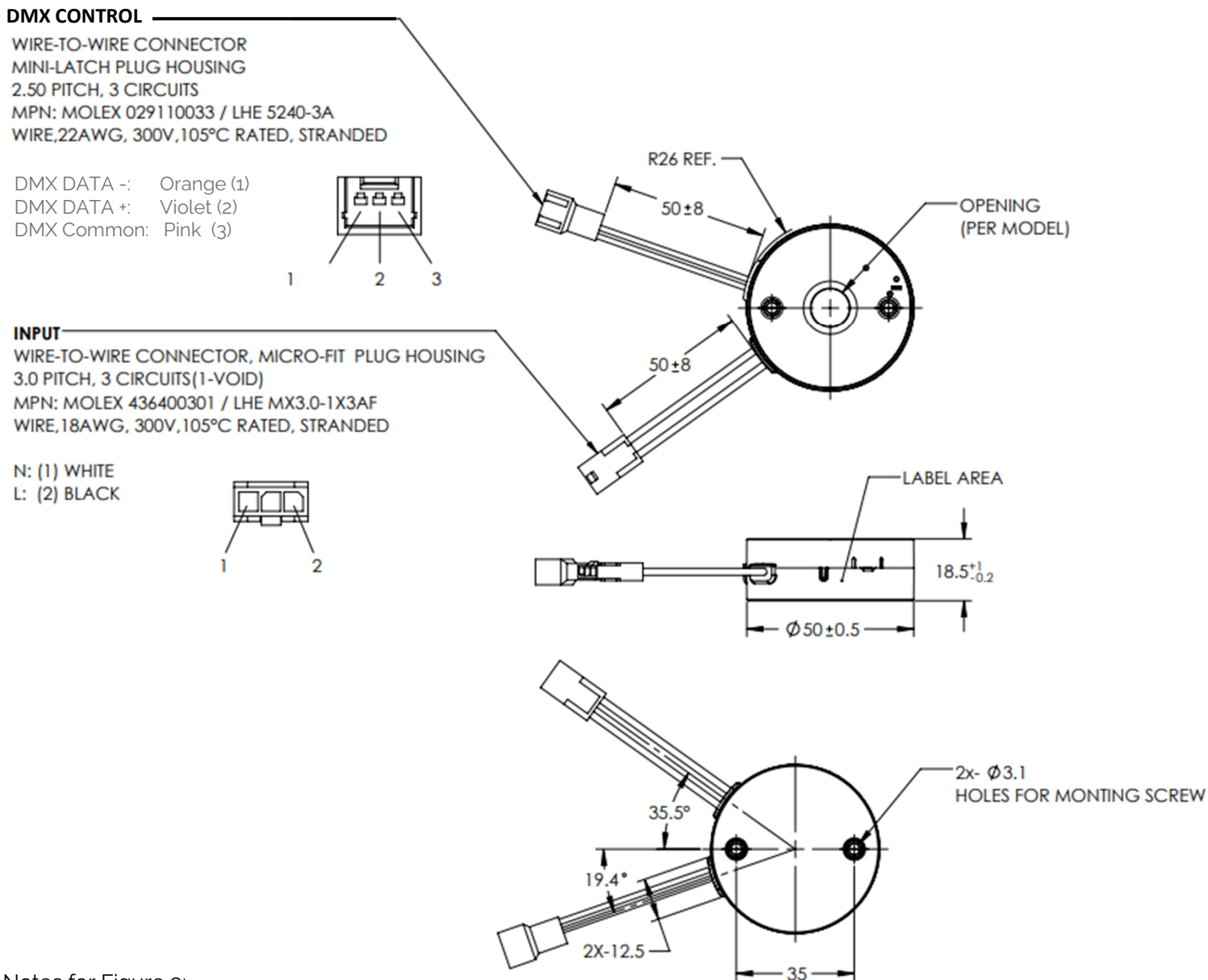

Notes for Figure 9:

1. Drawing dimensions are in millimeters
2. Unless otherwise specified, all linear tolerances are +/-1.0mm

Optical Accessories of the Light Engine

The Light Engine (LE) can order with the optical TIR lens holder. This holder can easily install various optics lens best for smooth color mixing.

Detail lens offering, can be referred to Bridgelux Website.



Thrive™ F90™ RGBW Component & Module ▾ Drivers ▾ Holders & Optics ▾ Power Devices ▾

Home > OPTICS

OPTICS

We've taken in your feedback and are thrilled to unveil the Bridgelux Integrated Solution. This solution includes Non-soldering Holders, Kirin Optics, and Drives, all designed to work together in harmony. The Optics, which are an essential part of this solution, come with a variety of beam angles, namely 15°, 24°, 36°, and 50°. Plus, they're available in different diameters, namely 35mm, 45mm, 55mm, up to 65mm. This variety ensures you find the perfect fit for your needs. What makes Bridgelux Optics even more special is their compatibility with our solder-free COB array holders, providing a smooth user experience. Our turn & lock design is a game-changer, it simplifies the adoption of our integrated lighting solution. In a nutshell, this design is a boon for manufacturers, lighting designers, and more, making the installation process easier than ever before. Additionally, we offer the opportunity for customization. We understand that needs can vary, so we're open to creating personalized solutions as per your specific requests. Customized solutions are available per customer request.

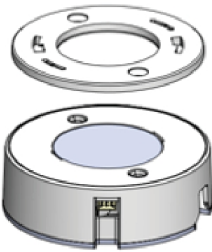

Product Family	Product	Data sheet	Doc Number	Diameter (mm)	Beam angle	Max LES (mm)	Material
BXHK	BXHK-MN-5024-xx-D09		DS1346	ø50, 24H	14, 24, 36, 50	9	PC
BXHK	BXHK-MN-5525-xx-D09		DS1347	ø55, 25H	14, 24, 36, 50	9	PC
BXHK	BXHK-MN-6230-xx-D09		DS1348	ø62, 30H	14, 24, 36, 50	9	PC
BXHK	BXHK-MN-6832-xx-D09		DS1349	ø68, 32H	14, 24, 36, 50	9	PC
BXHK	BXHK-DK-5024-xx-D09		DS1342	ø50, 24H	14, 24, 36, 50	9	PC
BXHK	BXHK-DK-5525-xx-D09		DS1343	ø55, 25H	14, 24, 36, 50	9	PC
BXHK	BXHK-DK-6230-xx-D09		DS1344	ø62, 30H	14, 24, 36, 50	9	PC
BXHK	BXHK-DK-6832-xx-D09		DS1345	ø68, 32H	14, 24, 36, 50	9	PC

Thermal Management of the Light Engine

Check the heat sink's temperature (T_c) with the Light Engine installed in the fixture under similar conditions to its final use. Aim for a T_c below 80°C .

The Light Engine has a safety feature that reduces power to the LEDs if T_c reaches 90°C .

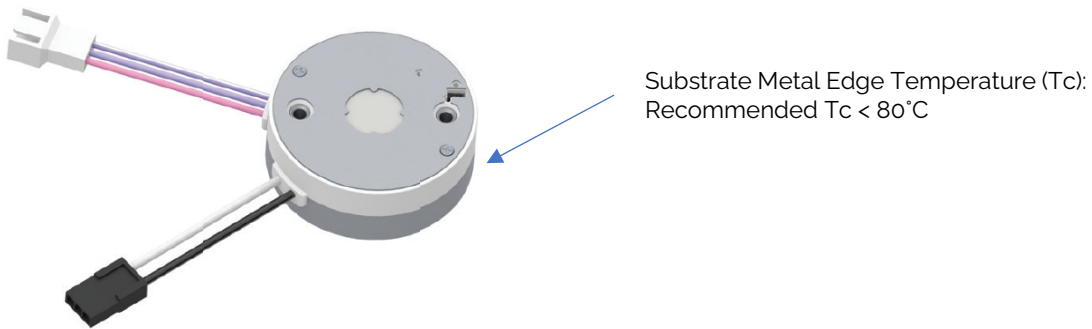

The Light Engine (LE) needs an external heat sink to maintain proper LED temperature. It has an aluminum base for efficient heat transfer, allowing simple heat sink designs. Several recommended heat sinks are listed with their performance at different Lumen outputs.

The LE can be installed in various fixtures, but solid contact with the heat sink and a thermally conductive material (at least $10 \text{ W}/(\text{m}^2\text{K})$) are crucial. Internal tests used an extruded heat sink. Proper airflow to the heat sink is essential to avoid overheating. The fixture's thermal design must keep the engine's base at the recommended temperature.

IMPORTANT: Heat sinks are usually tested in free air at 25°C . In insulated can fixtures, the LE might overheat. Test the heat sink in actual conditions for the desired application

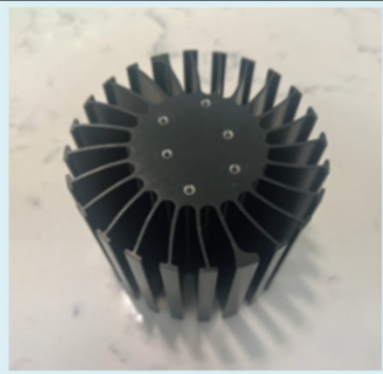
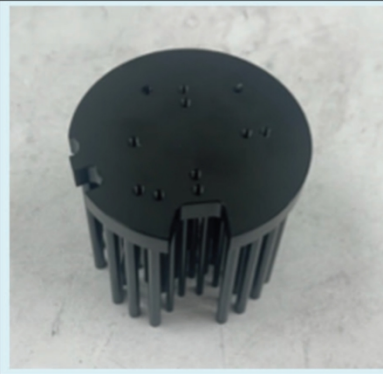
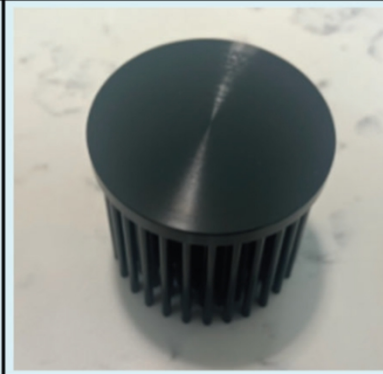
Manufacturer	Mechatronix	Mechatronix	Mechatronix
Model	GH36D 9980-B	LPF67A68-8-B	LPF70A50-5-B
			
	GH36D 9980-B, 120 Vac, Rev. X04, 4000K CCT	LPF67A68-8-B, 120 Vac, Rev. X04, 4000K CCT	LPF70A50-5-B, 120 Vac, Rev. X04, 4000K CCT
Light Engine Output (Lumen)	Ts at Ta of 40 °C		
850			
1000			69.1
1250			74.5
1500		72.8	79.9
2000		82.5	91.5
2500 (Max)	64.9	85.3	97.4

Cable Assemblies (AC Input Power Cable)

Table 6: AC Input Cables 1

Part Number	Configuration
BXDX-AC-NA400	2-wire AC Input Power Cable, Black/White, 400mm, for North America
BXDX-AC-NA100	2-wire AC Input Power Cable, Black/White, 100mm, for North America

Item No.	Part No. (UL)	Wire Description	Wire Color	Input
3	UL 1430	Wire Stranded Tinned 18 AWG (Pin-1)	White	Neutral
4	UL 1430	Wire Stranded Tinned 18 AWG (Pin-3)	Black	Line

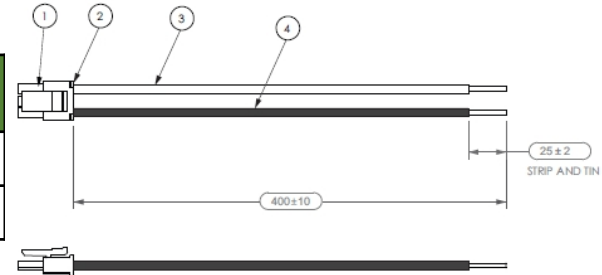
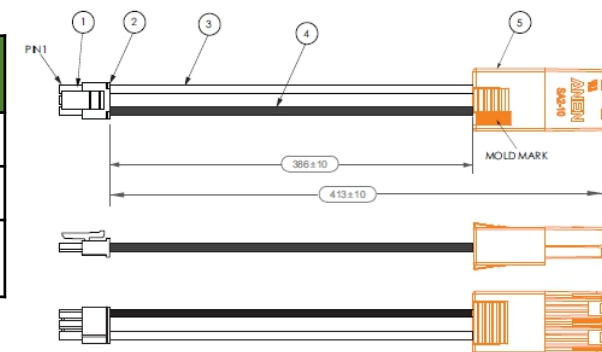

Table 7: AC Input Cables 2

Part Number	Configuration
BXDX-AC-NA413-QD	2-wire AC Input Power Cable, Black/White, 413mm, for North America, with quick disconnect
BXDX-AC-NA400-QDFL	2-wire AC Input Power Cable, Black/White, 400mm, for North America, with quick disconnect and flying leads

Item No.	Part No. (UL)	Wire Description	Wire Color	Input
3	UL 1430	Wire Stranded Tinned 18 AWG (Pin-1)	White	Neutral
4	UL 1430	Wire Stranded Tinned 18 AWG (Pin-3)	Black	Line
5	SA-2-10, Single	NBC ELECTRONIC 2-Pin Connector	Orange	



Item No.	Part No. (UL)	Manufacturer	Description	QTY
1	3016H-1*03	ECI	Connector 3-Pin	1
2	3016P-L	ECI	Connector Crimp	2

Cable Assembly (DC Control Cable)

Table 8: DC Control Cables

Part Number	Configuration
BXDX-DC3W-NA50	3-wire DC Control Cable, Violet/Orange/Pink, 100mm, for North America

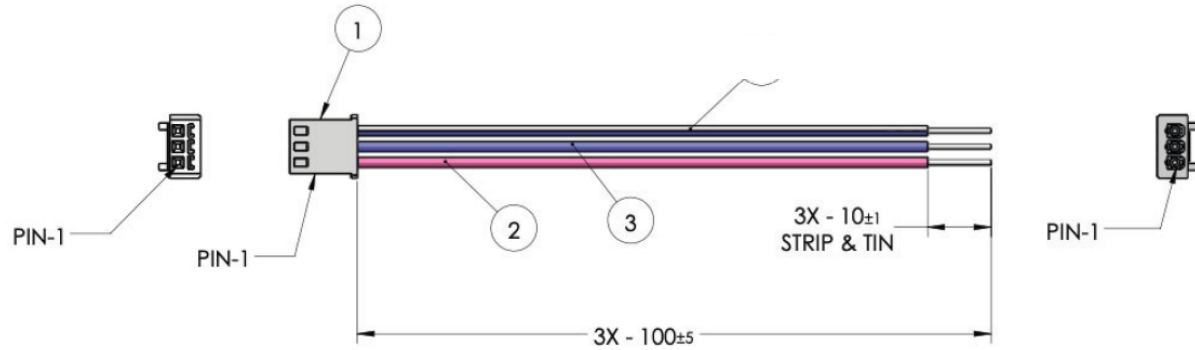

Item No.	Part No. (UL)	Manufacturer	Description	Input
1	5102-3Y	LHE or Equiv	2.50 mm Pitch Mini-Latch Receptacle Housing	N/A
2	UL 1430	Any	Wire Stranded Tinned 18 AWG Pink (Pin 1)	Dim (-)
3	UL 1430	Any	Wire Stranded Tinned 18 AWG Pink (Pin 1)	Dim (+)

Environmental and Regulatory Standards

Table 9: Environmental Conditions

Parameter	Specification
Ambient Operating Temperature	-20°C to +40°C <i>Light Engine can operate with $T_a > 40^\circ\text{C}$ by linearly de-rating the output lumen by 2.5%/°C (from 40°C - 60°C)</i>
Max. Case Temperature T_c	+90°C (max)
Humidity Rating	Maximum 95% Relative Humidity, non condensing
Storage Temperature	-40°C to + 85°C
Acoustic Noise	< 24 dBA (measured from 1M w/o/dimmer)
Expected Lifetime	50,000 hours ($T_c < 80^\circ\text{C}$)
Working Locations	Suitable for dry and damp locations
Warranty	5 Years ($T_c < 80^\circ\text{C}$)

Table 10: Regulatory Approvals and Compliance

Specification	Reference Standard	Condition
Conducted and Radiated EMI	FCC Title 47 Part 15B	Class B at 120VAC, Class A at 277VAC
Voltage Fluctuations & Flicker	IEC 61000-3-3	
ESD (Electrostatic Discharge)	IEC 61547:2009 Section 5.2 Test des.: IEC 61000-4-2	6 kV contact discharge, 8 kV air discharge, level 3
Radiated Immunity	IEC 61000-4-3	3 V/m, 80-1000 MHz, 80% modulated @ 3 meters, Level 2
Electrical Fast Transient	IEC 61547 Section 5.5 Test des.: IEC 61000-4-4	± 2KV on AC power port for 1minute, ± 1KV on signal/control lines
Surge Protection	IEC 61547 Section 5.7 Test des.: IEC 61000-4-5 or ANSI/IEEE C62.41-2002	± 2KV line to line / ± 2KV line to earth on AC power ports.
	ANSI/IEEE C62.41.1-2002	2.5kV Ring Wave
Conducted Immunity	IEC 61000-4-3	3V, 0.15-80 MHz, 80% modulated, Level 2
Voltage Dips	IEC 61547 Section 5.8, 5.9 Test des.: IEC 61000-4-11	>95% dip, .5 period; 30% dip, 25 periods; 95% reduction, 250 periods

Note: Unless otherwise specified, all the above parameters are measured at ambient temperature of 25°C and rated voltage.

Regulatory Standards (continued)

Table 11: Safety Agency Approvals

Specification	Reference Standard	Condition
UL / cUL	UL8750, CAN/CSA-C22.2 No. 250.13	UL Recognized, Class 2

Table 12: Protection

Specification	Reference Standard	Condition
Over Voltage Protection (OVP)	YES	Automatic recovery
OLP tolerance	100 – 110%	
Over Temperature Protection (OTP)	YES	Gradually reduce output power when $T_c < 85^\circ\text{C}$ Automatic recovery
Output Short-Circuit Protection (SCP)	YES	Automatic recovery



Design Resources

Application Notes

Please contact your Bridgelux sales representative for assistance on obtaining application support when designing with the Bridgelux DriveLux-X4 Light Engine. For a list of available resources, visit www.bridgelux.com.

Precautions

CAUTION: PRODUCT HANDLING

Handle the DriveLux-X4 Light Engine with care to prevent any damage from mechanical shock

It is recommended to handle this driver in a static-free environment

Do not open or disassemble the product

To maintain product warranty, the installer is responsible for ensuring that the driver's operating conditions do not exceed the maximum conditions stated within this data sheet

CAUTION: ELECTRIC SHOCK

Be aware of the possibility of an electric shock hazard which can result in serious injury or death. Disconnect power before servicing or installing this device.

Disclaimers

MINOR PRODUCT CHANGE POLICY

The rigorous qualification testing on products offered by Bridgelux provides performance assurance.

Slight cosmetic changes that do not affect form, fit, or function may occur as Bridgelux continues product optimization.

About Bridgelux: Bridging Light and Life™

At Bridgelux, we help companies, industries and people experience the power and possibility of light. Since 2002, we've designed LED solutions that are high performing, energy efficient, cost effective and easy to integrate. Our focus is on light's impact on human behavior, delivering products that create better environments, experiences and returns—both experiential and financial. And our patented technology drives new platforms for commercial and industrial luminaires.

For more information about the company, please visit

bridgelux.com

twitter.com/Bridgelux

facebook.com/Bridgelux

youtube.com/user/Bridgelux

linkedin.com/company/bridgelux

WeChat ID: BridgeluxInChina



46410 Fremont Blvd
Fremont, CA 94538 USA
Tel (925) 583-8400
www.bridgelux.com