



# Bridgelux® Pallas-OD IP67 Channel 320W (0-10V) Driver

Product Data Sheet DS1292

## Product Feature Map

Bridgelux Pallas-OD(0-10V) Single Channel IP67 320W Driver provides dynamic constant current output for LED modules and arrays. This Driver interoperates with 0-10V standard lighting systems and protocols and allows for simple integration of Bridgelux's and all major brands White Arrays and Linear modules. Please visit [www.bridgelux.com](http://www.bridgelux.com) for more information.

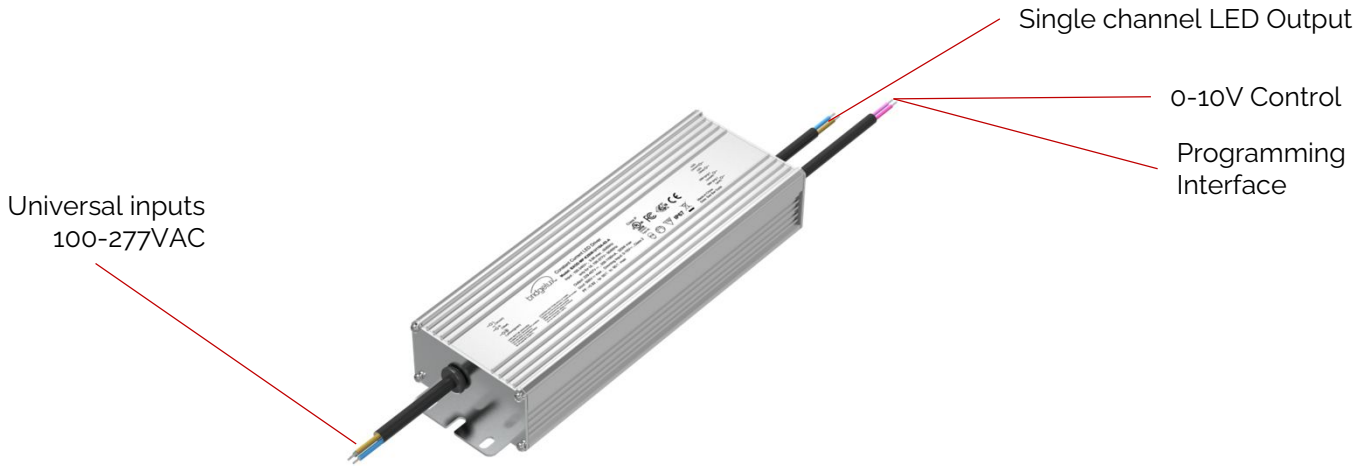

### Product Nomenclature

The part number designation for Bridgelux Pallas-OD(0-10V) Single Channel 320W Driver is explained as follows:

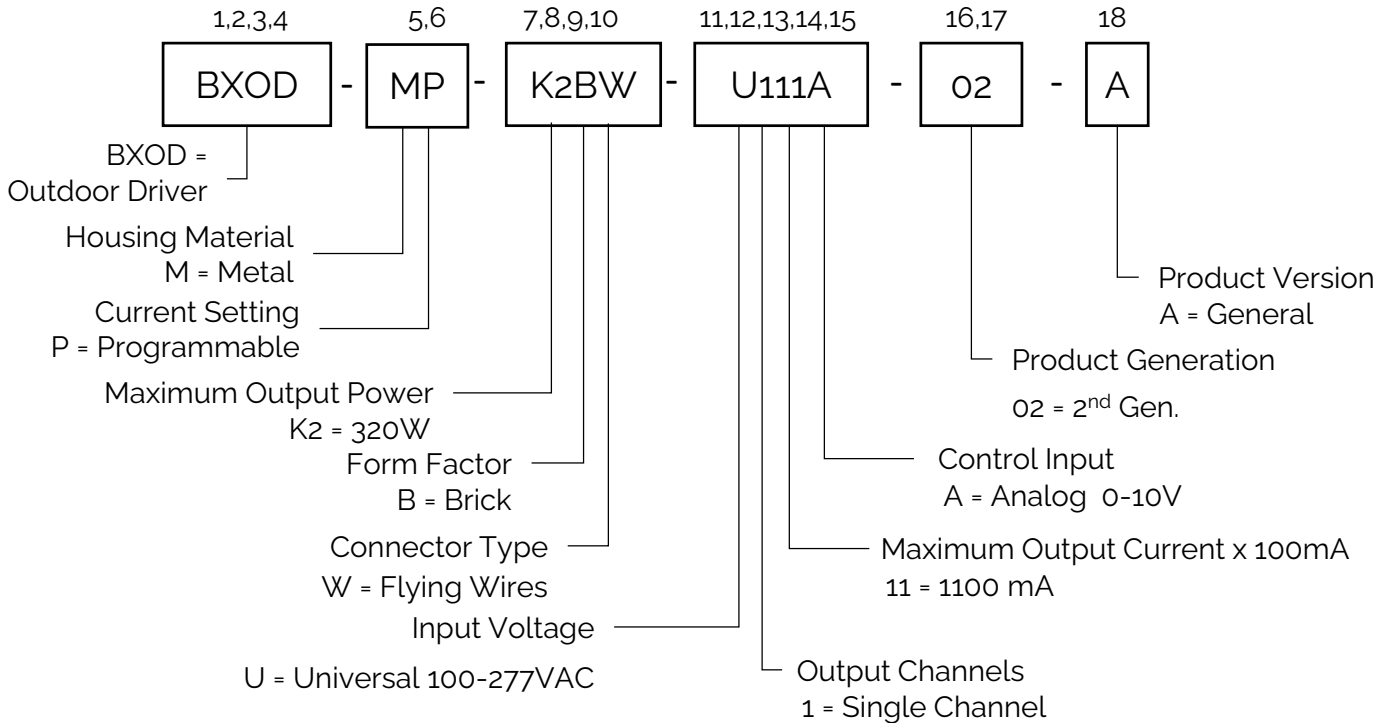

Table 1: Product Selection Guide (examples)

Part Number	Configuration
BXOD-MP-K2BW-U11A-02-A	Outdoor, 320W, Universal Inputs 100-277V

## Electrical Characteristics

Table 2: Input Electrical Characteristics

Parameter	Unit	Specification
Nominal voltage	V	100 - 277 VAC
Nominal frequency	Hz	50 / 60 Hz
AC voltage range	V	90 - 305 VAC
Input current (max)	A	< 3.15 A (@ 100V)
THD (Full load)	%	< 20% (@ 120V/277V, 80 - 100%) < 10% (@ 230V, @100%)
Power factor (Full load)	-	>0.9 (@ 120V/277V, 80 - 100%) >0.97 (@ 230V, @100%)
Efficiency (Full load)	%	> 92.9% (@ 120V) > 94.8% (@ 220V) > 95.0% (@ 277V)
NO load	W	≤ 3.0 W
Inrush current(Cold start)	A pk	< 40A (@120Vac, cold start) < 69A (@230Vac, cold start) < 98A (@277Vac, cold start)
Leakage Current	μA	750 μA (@ Full Load)

Table 3: Output Electrical Characteristics

Parameter	Unit	Specification
Nominal voltage range	V	229 - 457V (see Operating Window)
Maximum voltage(Open Circuit)	Vdc	≤ 500 V
Programmable Output Current	mA	350 - 1100 mA
Dimming Range	%	10% - 100%
Current accuracy	%	+/- 5 %
Line Regulation	%	< 2%
Load Regulation	%	< 5%
Current ripple 100Hz	%	≤ 10 %
Pst LM	-	≤ 1
SVM	-	≤ 0.4
Output Power (Max)	W	320 W
Output Current Overshoot	%	< 10% (Turning ON)

## Electrical Characteristics

Table 4: 0-10V / 1-10V Dimming Control Characteristics

Parameter	Unit	Specification
Dim+, Dim-	-	The 0~10V or resistor dimming can be used to dim the output current via a standard commercial wall dimmer (0~10VDC) or an external control voltage source (0~10VDC) or external resistor.
Dimming Curve	-	Linear (see "Dimming Curve")
Source Current on 0~10V Dimming Pin	-	< 450 $\mu$ A
Dimming Voltage for Full Bright	V	> 9.0V (Programmable)
External Resistor Value at Full Bright	$\Omega$	100 k $\Omega$

Figure 1: 0 – 10V Dimming Curve

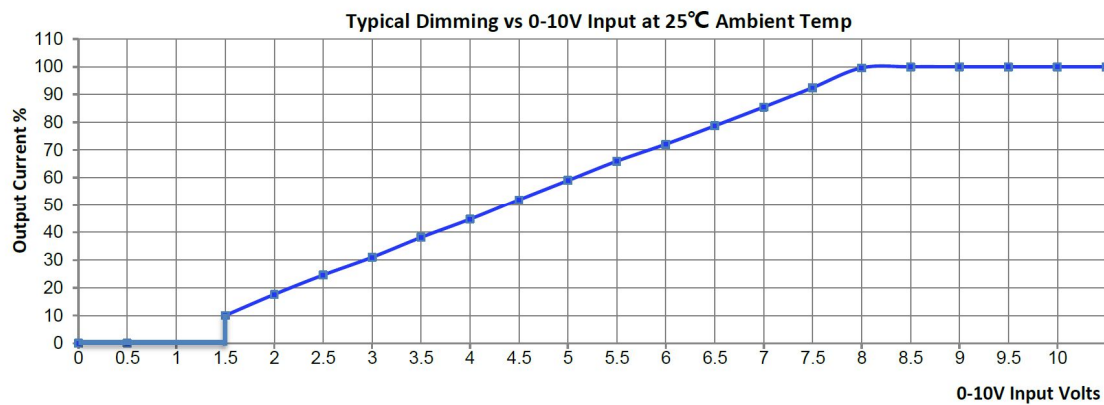
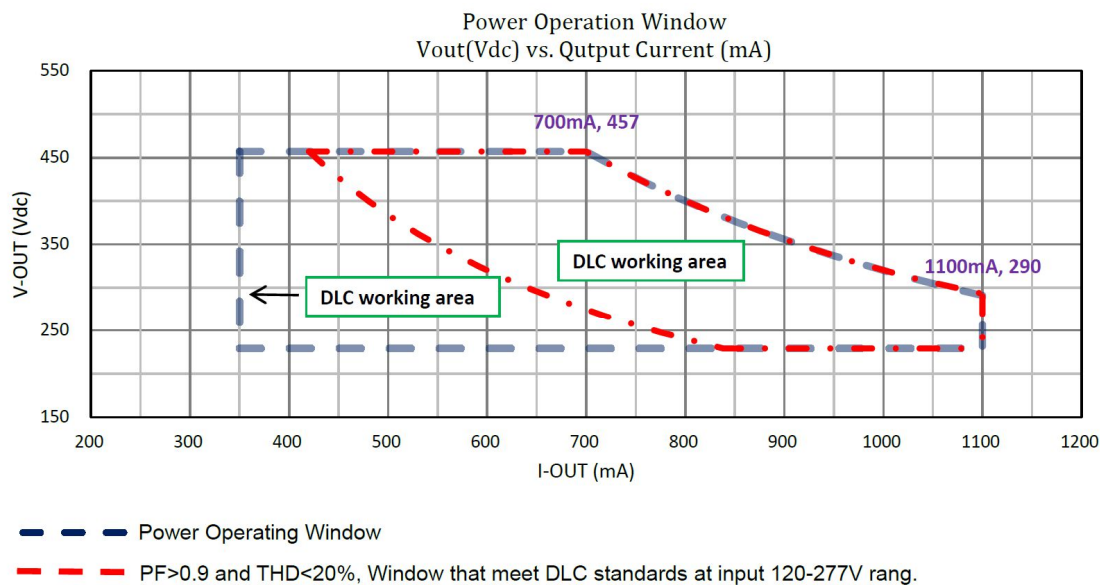

Figure 2: Operating Window



Note: Driver is in constant power mode from 5350mA to 7600mA.

## Electrical Characteristics

Figure 3: Power Factor vs. Output Power

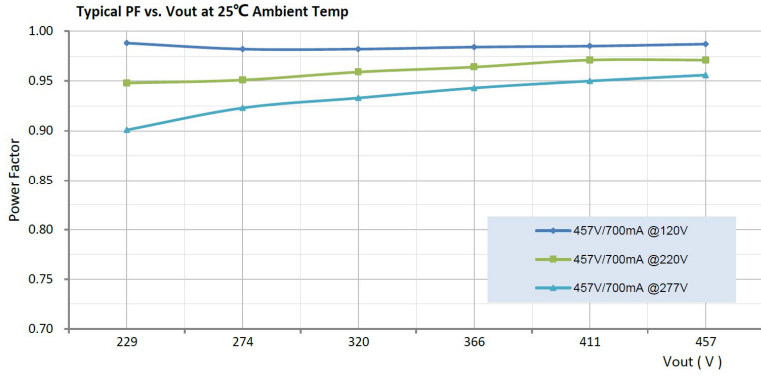

Figure 4: THD vs Output Power

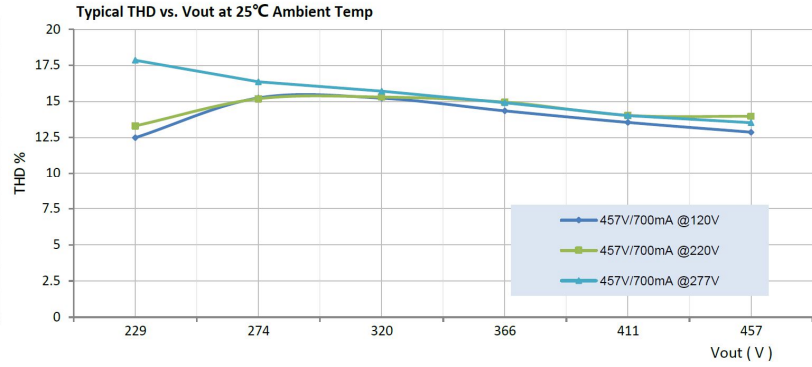
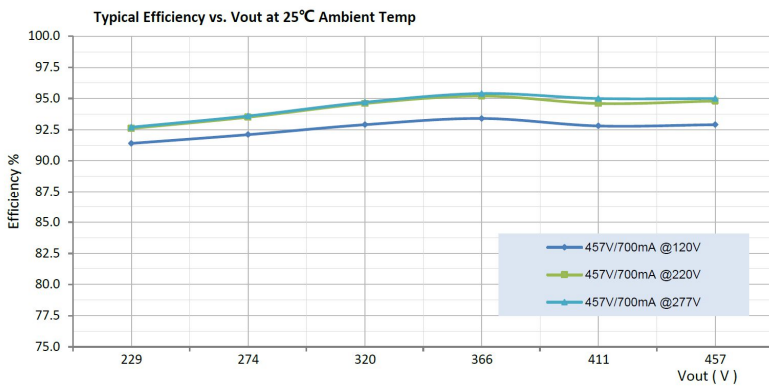

Figure 5: Efficiency vs Output





## Wiring Diagram

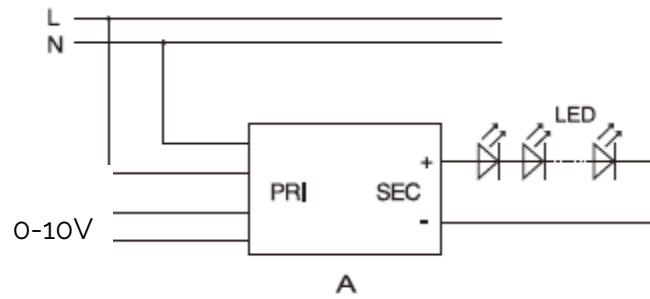

Table 6: **Wiring**

PRI	Cable cross-section	AWG 18
SEC / DIM / AUX	Cable cross-section	AWG 18 (LED) AWG 22 (Dimming)

Notes for Table 6:

1. Hot plug-in or secondary switching of LEDs is not permitted and may cause a very high current to the LEDs.
2. Unless otherwise specified, all linear tolerances are +/-1.0mm

## Driver Programming

The Pallas-OD Single Channel 320W Driver provides a programming port, which allows for programming specific driver settings in accordance with customer preferences. The Driver does not need to be powered during the programming of the driver settings.

Bridgelux provides a programmer for programming the Pallas-OD Single Channel Driver. For more information on the programmer, please see the Pallas-OD Programmer data sheet on [www.bridgelux.com](http://www.bridgelux.com) or contact your local Bridgelux sales representative.

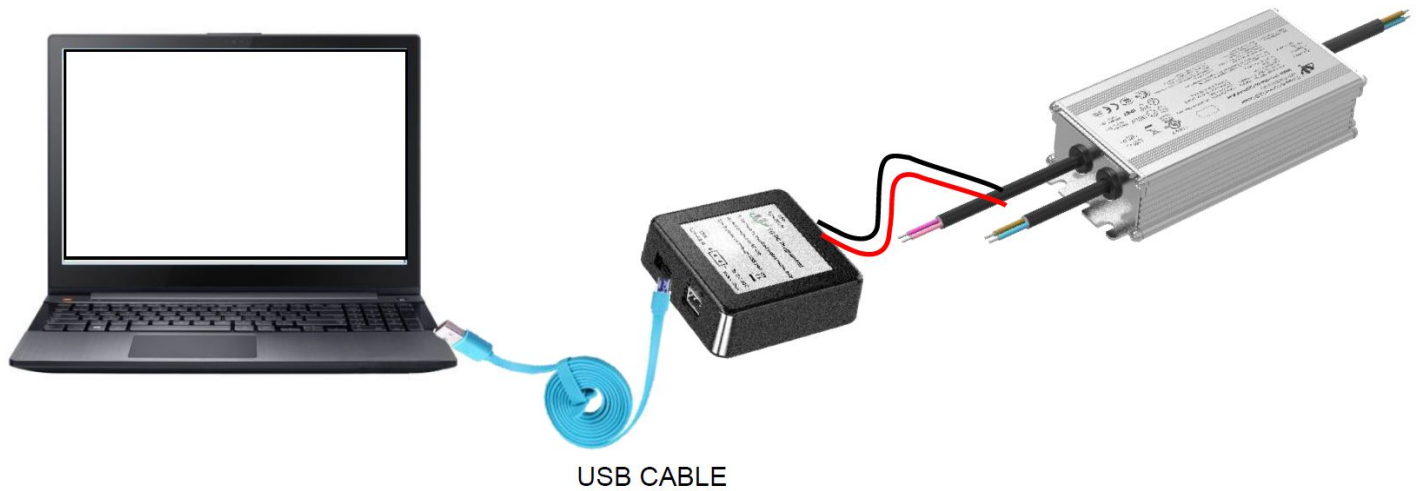

## Installation

### ■ UL Cable used in Dry & Damp Location:

AC input cable, the three cores, ANSI/UL2733 18AWG 3C -40°C~105 °C PVC 600V Black、 White、 Green\Yellow  
Cable Length: 230mm, External stripping 57mm, Stripping on the tin: 10mm.

Where: L — Black wire, N — White wire, GND — Green\Yellow wire.

DC output cable, the two cores, ANSI/UL2733 18AWG 2C -40°C~105 °C PVC 600V Red、 Blue

Cable Length: 230mm, External stripping 57mm, Stripping on the tin: 10mm.

Where: DC+ — Red wire, DC- — Blue wire.

Dimming control cable, the three cores, ANSI/UL2733 22AWG 2C -40°C~105 °C PVC 600V Purple、 Pink

Cable Length: 310mm, External stripping 57mm, Stripping on the tin: 10mm.

Where: DIM+ (0-10V or PWM) input — Purple wire, DIM- — Pink wire

### ■ UL & CE, CCC, ENEC Standard used in Wet Location:

AC input for connection the three cores copper wire connection.

Outdoor Type (IP67): IEC 60245 /VDE 0282-4 / H05RN-F (SJOW) 17AWG 3x1.0mm<sup>2</sup> -40°C~105 °C Rubber 300V  
Brown、 Blue、 Green\Yellow

Cable Length: 230mm, stripping on the tin: 10mm.

Where: L — Brown wire, N — Blue wire, GND — Yellow/Green wire.

DC output for connection the two core copper wire.

Outdoor Type (IP67): IEC 60245 /VDE 0282-4 / H05RN-F (SJOW) 17AWG 2x1.0mm<sup>2</sup> -40°C~105 °C Rubber 300V Brown、  
Blue

Cable Length: 230mm, stripping on the tin: 10mm.

Where: DC+ — Brown wire, DC- — Blue wire.

The dimmer control input is the three copper wires. ANSI/UL21996 22AWG 2C -40°C~105 °C PVC 300V Purple、 Pink

Cable Length: 310mm, stripping on the tin: 10mm.

Where: DIM+ (0-10V or PWM) input — Purple wire, DIM- — Pink wire.

## Environmental and Regulatory Standards

Table 8: Environmental Conditions

Parameter	Specification
Ambient Operating Temperature	-40°C to + 50°C
Max. Case Temperature Tc	+90°C (max)
Humidity Rating	Maximum 90% Relative Humidity, non condensing
Storage Temperature	-40°C to + 85°C
Expected Lifetime	50,000 hours (Tc < 75°C)
Working Locations	Suitable for Wet locations
Warranty	5 Years (Tc < 75°C)

Table g: Regulatory Approvals and Compliance

Specification	Reference Standard	Condition
Conducted and Radiated EMI	FCC Title 47 Part 15, ANSI C63.4:2009  EN55015:2013+A1:2015 EN61000-3-2:2014 EN61000-3-3:2013	
Conduction Emission	EN IEC 55015:2019+A11:2020	
Radiation Emission	EN IEC 55015:2019+A11:2020	
Harmonics Current Emission	IEC/EN 61000-3-2:2019+A1:2021	Class C
Surge	IEC/EN61000-4-5 ANSI/C82.77-5-2017	DM: 6kV CM: 10kV, Criterion B DM: 6kV CM: 6kV, Criterion B
Ring Wave	IEC/EN61000-4-12; ANSI/C82.77-5-2017	DM: 6kV CM: 6kV, Criterion B

## Regulatory Standards (continued)

Table 10: Safety Agency Approvals

Specification	Reference Standard	Condition
UL / cUL	UL8750, CAN/CSA-C22.2 No. 250.13	UL Listed, Class 2, Class P
ENEC	EN61347-1:2015, EN61347-2-13:2014	

Table 11: Protection

Specification	Reference Standard	Condition
Over Voltage Protection (OVP)	YES	Automatic recovery
Over Current Protection (OCP)	Yes	Constant Current Limiting circuit
Over Temperature Protection (OTP)	YES	@ 100°C
Output Short-Circuit Protection (SCP)	YES	Automatic recovery



## Safety Test Items

### Safety Test Items

Safety Test Items	Technical Indicators			Remark
Insulation Requirements	UL Insulation Requirements	ENEC Insulation Requirements	CCC Insulation Requirements	
Input-Output	1600Vac	3000Vac	3750Vac	Reinforced insulation
Input-Case	1600Vac	1500Vac	1875Vac	Basic insulation
Input-Dim	1600Vac	3000Vac	3750Vac	Reinforced insulation
Output-Dim	1600Vac	1000Vac	1000Vac	Basic insulation
Output-Case	500Vac	1000Vac	1000Vac	Basic insulation
Dim-Case	500Vac	250Vac	500Vac	Basic insulation
Insulation Resistance	≥10MΩ			Input-Output, Test voltage:500Vdc @ 25°C, 70% RH
Ground Resistance	≤0.1Ω			25A/1min
Leakage Current	≤0.75mA			277Vac

**Note:**

- 1.The above test data are in the condition of 25°C ambient temperature, except for the marked temperature.
- 2.The CCC withstand voltage test needs to disconnect the built-in lightning protection tube. According to the IEC 60598-1:14 standard section 10.2, the built-in lightning protection tube<sup>o</sup> can be marked on the nameplate to disconnect the discharge tube on testing.
- 3.Please short (ACL and ACN), (V+ and V-), (Dim+ and Dim -) when Hi-pot test.
- 4.warrants the LED Driver itself complies with EMC standard. However, LED Driver's EMC should be re-checked when integrated into lighting systems due to unexpected interference of components.

## Design Resources

### Application Notes

Please contact your Bridgelux sales representative for assistance on obtaining application support when designing with the Bridgelux Pallas-OD Single Channel Driver. For a list of available resources, visit [www.bridgelux.com](http://www.bridgelux.com).

## Precautions

### CAUTION: PRODUCT HANDLING

Handle the Pallas-OD Single Channel Driver with care to prevent any damage from mechanical shock. It is recommended to handle this driver in a static-free environment. Do not open or disassemble the product. To maintain product warranty, the installer is responsible for ensuring that the driver's operating conditions do not exceed the maximum conditions stated within this data sheet.

### CAUTION: PRODUCT INSTALLATION

Incorrect installation of the Pallas-OD Single Channel Driver can cause irreparable damage to the driver, connected LEDs. Pay attention when connecting the LED load and observe the correct polarity of the output terminals as specified in this data sheet and on the driver label.

### CAUTION: ELECTRIC SHOCK

Be aware of the possibility of an electric shock hazard which can result in serious injury or death. Disconnect power before servicing or installing this device.

## Disclaimers

### MINOR PRODUCT CHANGE POLICY

The rigorous qualification testing on products offered by Bridgelux provides performance assurance. Slight cosmetic changes that do not affect form, fit, or function may occur as Bridgelux continues product optimization.

## About Bridgelux: Bridging Light and Life™

At Bridgelux, we help companies, industries and people experience the power and possibility of light. Since 2002, we've designed LED solutions that are high performing, energy efficient, cost effective and easy to integrate. Our focus is on light's impact on human behavior, delivering products that create better environments, experiences and returns—both experiential and financial. And our patented technology drives new platforms for commercial and industrial luminaires.

For more information about the company, please visit

[bridgelux.com](http://bridgelux.com)

[twitter.com/Bridgelux](https://twitter.com/Bridgelux)

[facebook.com/Bridgelux](https://facebook.com/Bridgelux)

[youtube.com/user/Bridgelux](https://youtube.com/user/Bridgelux)

[linkedin.com/company/bridgelux](https://linkedin.com/company/bridgelux)

WeChat ID: BridgeluxInChina



46410 Fremont Blvd  
Fremont, CA 94538 USA  
Tel (925) 583-8400  
[www.bridgelux.com](http://www.bridgelux.com)