

Bridgelux® Vesta® Series Tunable White Gen 3 15mm Array

Product Data Sheet DS496



Product Feature Map

Bridgelux arrays are fully engineered devices that provide consistent thermal and optical performance on an engineered mechanical platform. The arrays incorporate several features to simplify design integration and assembly. Please visit www.bridgelux.com for more information on the Vesta Series family of products.

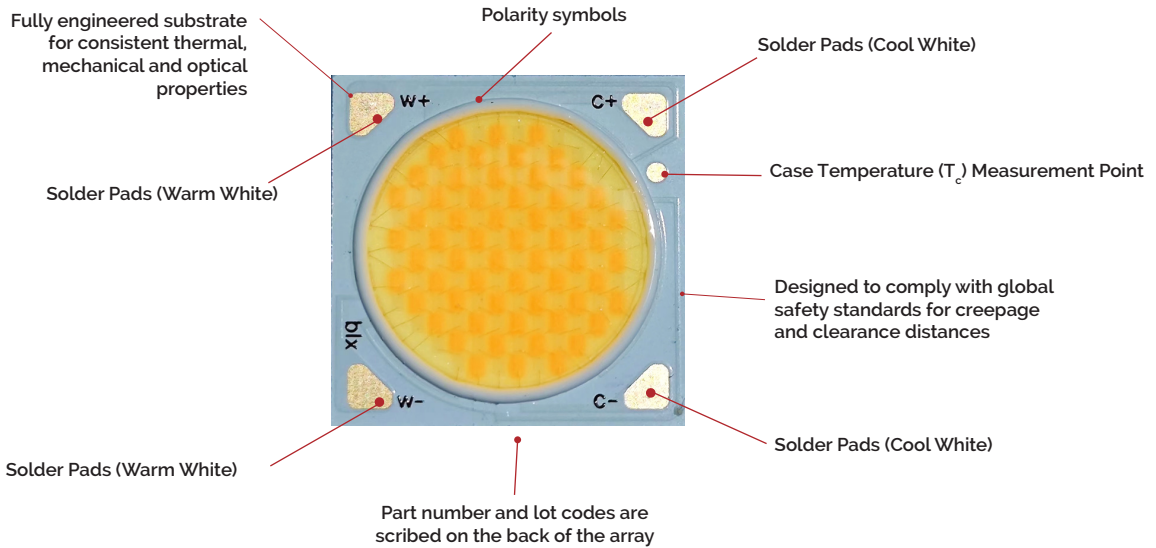

Product Nomenclature

The part number designation for Bridgelux Vesta Series arrays is explained as follows:

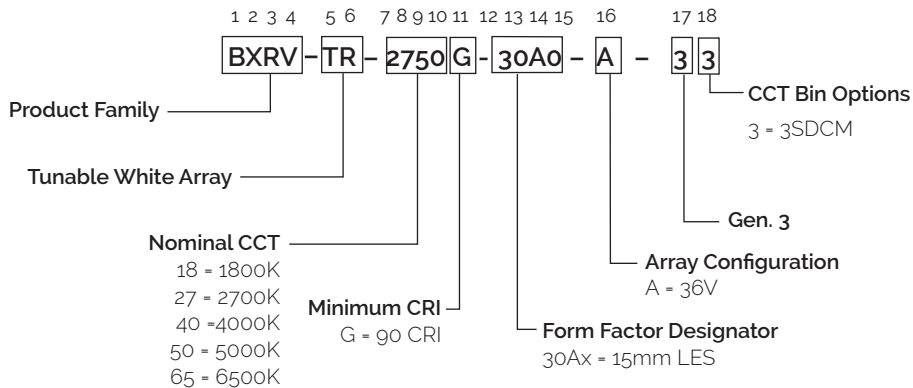

Product Selection Guide

The following product configurations are available:

Table 1: Selection Guide, Measurement Data

Part Number	Nominal CCT ¹ T _c =85°C (K)	Minimum CRI ² T _c =85°C	Nominal Drive Current per channel (mA)	Typical V _f ³ T _c =25°C (V)	Typical Power T _c =25°C (W)	Typical Pulsed Flux ^{3,4,5} T _c =25°C (lm)	Typical Efficacy ⁵ T _c =25°C (lm/W)	Minimum Pulsed Flux ⁸ T _c =25°C (lm)	Typical DC Flux ^{7,8} T _c =85°C (lm)
BXRV-TR-2750G-30A0-A-33	2700	90	650	36.4	23.7	2900	123	2610	2610
	5000	90	650	36.4	23.7	3250	137	2925	2925
BXRV-TR-2765G-30A0-A-33	2700	90	650	36.4	23.7	2900	123	2610	2610
	6500	90	650	36.4	23.7	3250	137	2925	2925

Notes for Table 1:

- Nominal CCT as defined by ANSI C78.377-2011.
- For CRI 90 products, the minimum CRI value is 90 and the minimum R9 value is 50. Bridgelux maintains a ±3 tolerance on all CRI and R9 values.
- Products tested under pulsed condition (10ms pulse width) at nominal drive current where T_j (junction temperature) = T_c (case temperature) = 25°C.
- Typical performance values are provided as a reference only and are not a guarantee of performance.
- Bridgelux maintains a ±7% tolerance on flux measurements.
- Typical stabilized DC performance values are provided as reference only and are not a guarantee of performance.
- Typical performance is estimated based on operation under DC (direct current) with LED array mounted onto a heat sink with thermal interface material and the case temperature maintained at 85°C. Based on Bridgelux test setup, values may vary depending on the thermal design of the luminaire and/or the exposed environment to which the product is subjected.
- Minimum flux values at pulsed nominal drive current are guaranteed by 100% test.

European Product Registry for Energy Labeling

The European Product Registry for Energy Labeling (EPREL) is defined in the EU Regulation 2017/1369 to provide information about a product's energy efficiency to consumers. Together with Energy Labeling Regulation ELR (EU) 2019/2015, which was amended by regulation (EU) 2021/340 for energy labelling of light sources, manufacturers are required to declare an energy class based on key technical specifications from each of their product and register it in an open data base managed by EPREL. It is now a legal requirement for a vendor of light sources to upload information about their products into the EPREL database before placing these products on the market in the EU.

Table 2 provides a list of part numbers that are in compliance with EPREL regulations and are currently listed in the EPREL database.

At Bridgelux, we are fully committed to supplying products that are compliant with pertinent laws, rules, and obligation imposed by relevant government bodies including the ELR regulation. Customers can use these products with full confidence for any projects that fall under the EPREL requirement.

Table 2: Table of products registered in the European Product Registry for Energy Labeling (EPREL)

Part Number	CCT (K)	CRI	Current ³ (mA)	Voltage ³ (V)	Useful Flux ² Φ_{useful} Tc=85°C (lm)	Power (W)	Efficacy (lm/W)	Energy Efficiency Class ⁴ 	Registration No	URL ¹
BXRV-TR-2765G-30A0-A-33	6500	90	1200	38.4	5031	46	109	F	2229664	https://eprelec.europa.eu/qr/2229664

Notes for Table 2:

1. The performance data in this table is a subset of the data that was submitted to EPREL for obtaining the energy class listed here. For accessing a complete set of technical documentation of Bridgelux registered products in the EPREL database, please visit one of the hyperlinks listed above.
2. For a definition of useful luminous flux (Φ_{useful}), please see the ELR regulations at <https://tinyurl.com/4b6zvt4m>.
3. For information on performance values at alternative drive conditions, please refer to the Product Selection Guide, Absolute Maximum Rating Table and Performance Curves in this data sheet.
4. EPREL requires a symbol for displaying the energy classification of a product in marketing literature. This symbol consists of a letter stating a product's energy efficiency class inside a specific arrow logo as defined by EPREL.
5. All products listed here must be disposed as e-waste according to the guidelines in the country in which the product is used.

Electrical Characteristics

Table 3: Electrical Characteristics

Part Number	CCT	Nominal Drive Current (mA)	Forward Voltage Pulsed, $T_c = 25^\circ\text{C}$ (V) ^{1,2,3,7}			Typical Temperature Coefficient of Forward Voltage ⁴ $\Delta V_f / \Delta T_c$ (mV/ $^\circ\text{C}$)	Typical Thermal Resistance Junction to Case ⁵ R_{j-c} ($^\circ\text{C}/\text{W}$)	Driver Selection Voltages ⁶ (V)	
			Minimum	Typical	Maximum			V_f Min. Hot $T_c = 105^\circ\text{C}$ (V)	V_f Max. Cold $T_c = -40^\circ\text{C}$ (V)
BXR-V-TR-xxxxG-30Ax-A-33	1800K/2700K	650	34.4	37.0	39.6	-20.50	0.28	32.8	40.9
	4000K/5000K/6500K	650	34.4	37.0	39.6	-20.50		32.8	40.9

Notes for Table 3:

- Parts are tested in pulsed conditions. $T_c = 25^\circ\text{C}$. Pulse width is 10ms.
- Voltage minimum and maximum are provided for reference only and are not a guarantee of performance.
- Bridgelux maintains a tester tolerance of $\pm 0.10\text{V}$ on forward voltage measurements.
- Typical temperature coefficient of forward voltage tolerance is $\pm 0.1\text{mV}$ for nominal current.
- Thermal resistance value was calculated using total electrical input power; optical power was not subtracted from input power. The thermal interface material used during testing is not included in the thermal resistance value.
- V_f min hot and max cold values are provided as reference only and are not guaranteed by test. These values are provided to aid in driver design and selection over the operating range of the product.
- This product has been designed and manufactured per IEC 62031:2018. This product has passed dielectric withstand voltage testing at 500V. The working voltage designated for the insulation is 60V DC. The maximum allowable voltage across the array must be determined in the end product application.

Absolute Maximum Ratings

Table 4: Maximum Ratings

Parameter	Maximum Rating	
LED Junction Temperature (T_j)	125°C	
Storage Temperature	-40°C to +105°C	
Operating Case Temperature ¹ (T_c)	105°C	
Soldering Temperature ²	350°C or lower for a maximum of 6 seconds	
Maximum Combined Drive Current ⁴	1200mA	
	Channel 1 1800K/2700K	Channel 2 4000K/5000K/6500K
Maximum Drive Current Per Channel ^{3,4}	1200mA	1200mA
Maximum Peak Pulsed Drive Current ⁵	1700mA	1700mA
Max Reverse Voltage	-60V	

Notes for Table 4:

1. For IEC 62717 requirement, please contact Bridgelux Sales Support.
2. See Bridgelux Application Note AN101 for more information.
3. Lumen maintenance and lifetime predictions are valid for drive current and case temperature conditions used for LM-80 testing as included in the applicable LM-80 test report. Contact your Bridgelux sales representatives for the LM-80 report.
4. The maximum combined drive current is the sum of the currents in both channels. For example, if 1200mA is applied to the 1800K/2700K channel, no current may be applied to the 4000K/5000K/6500K channel of the array. If 300 mA is applied to the 1800K/2700K channel, then a maximum of 900 mA can be applied to the 4000K/5000K /6500Kchannel.
5. Bridgelux recommends a maximum duty cycle of 10% and pulse width of 20ms when operating LED arrays at the maximum peak pulsed current specified. Maximum peak pulsed currents indicate values where the LED array can be driven without catastrophic failures.

Performance Curves

Figure 1: Forward Voltage vs. Forward Current, $T_c=25^\circ\text{C}$

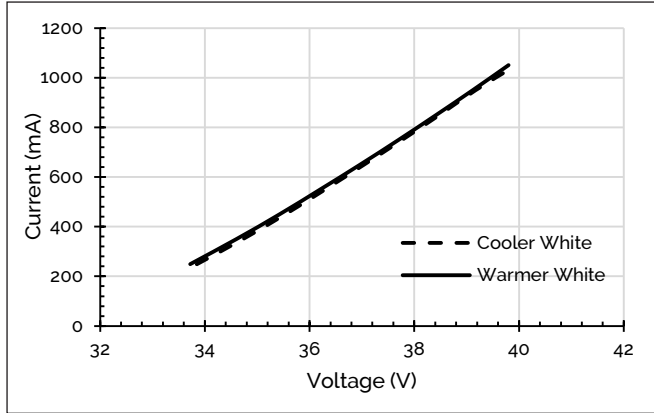

Figure 2: Relative Flux vs. Drive Current, $T_c=25^\circ\text{C}$

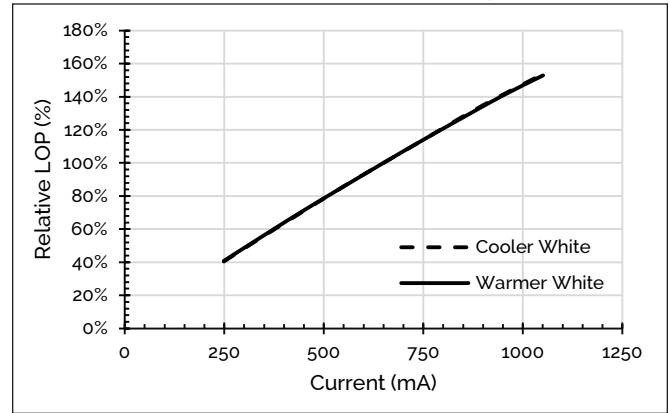

Figure 3: Relative Voltage vs. Case Temperature

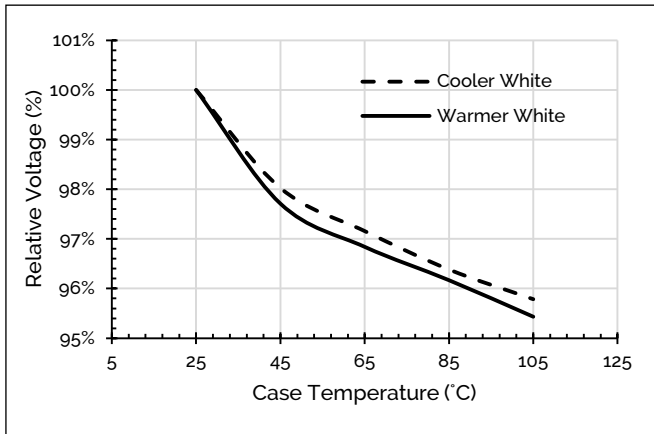

Figure 4: Relative Light Output vs. Case Temperature

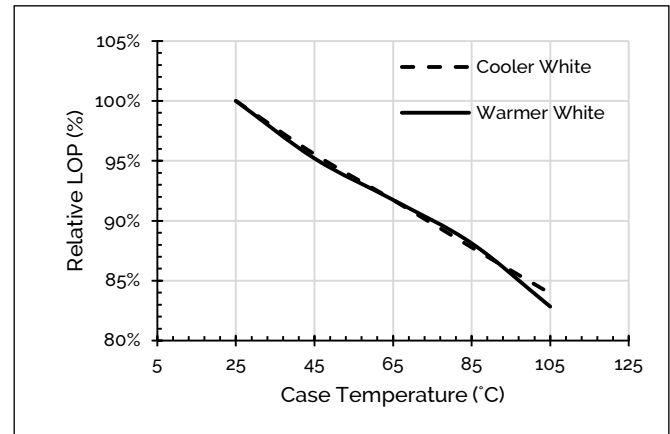

Figure 5: CCT Tuning Range, $T_c=85^\circ\text{C}$

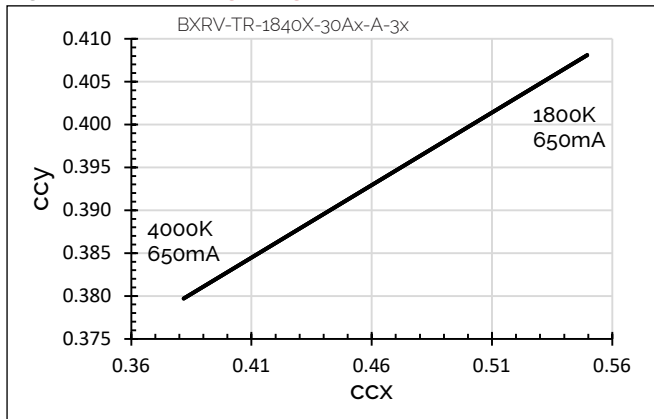
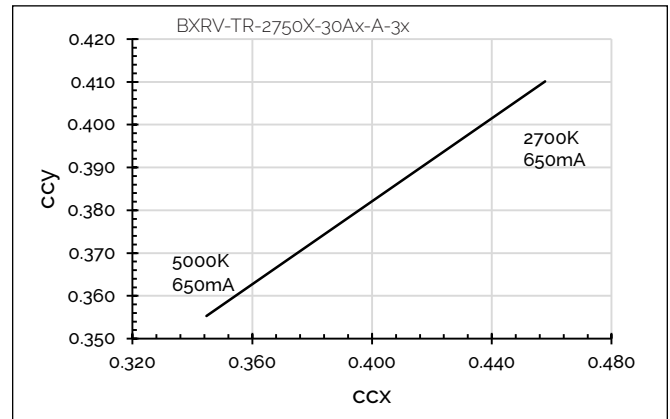

Figure 6: CCT Tuning Range, $T_c=85^\circ\text{C}$



Performance Curves

Figure 7: CCT Tuning Range, Tc=85°C

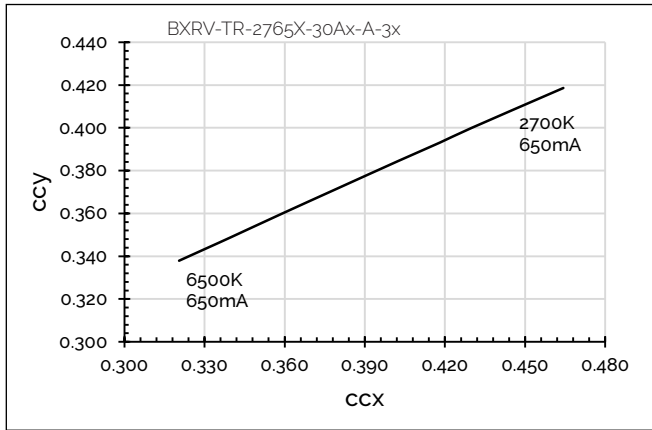

Figure 8: CCT vs. Relative Warm White Current

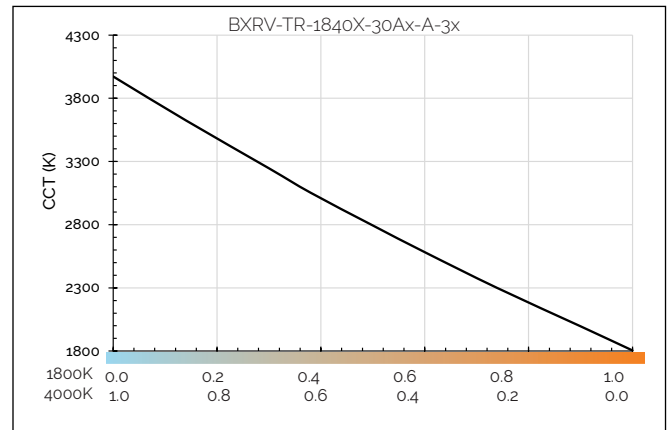

Figure 9: CCT vs. Relative Warm White Current

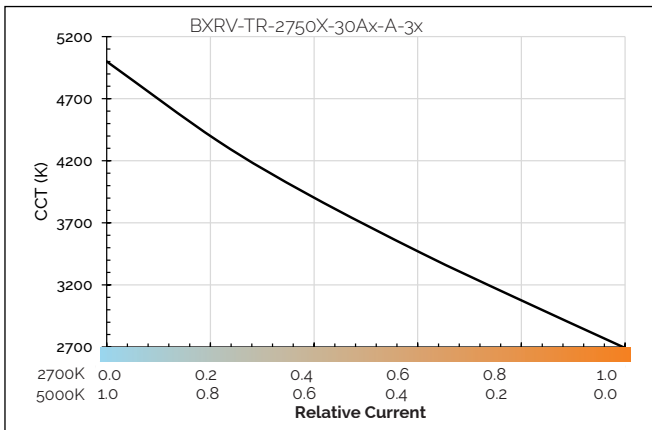

Figure 10: Relative Flux vs. Relative Current

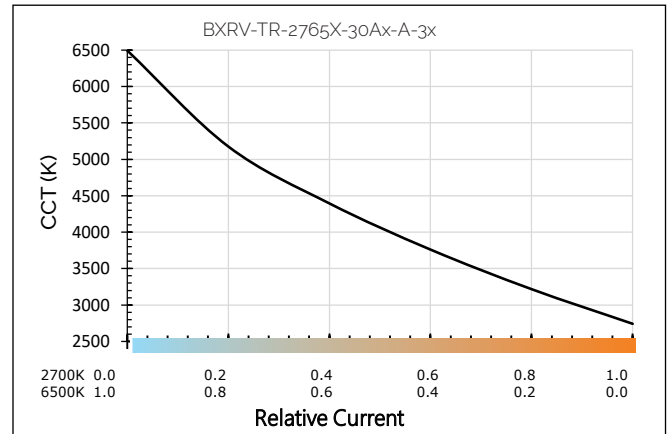

Figure 11: Relative Flux vs. Relative Current

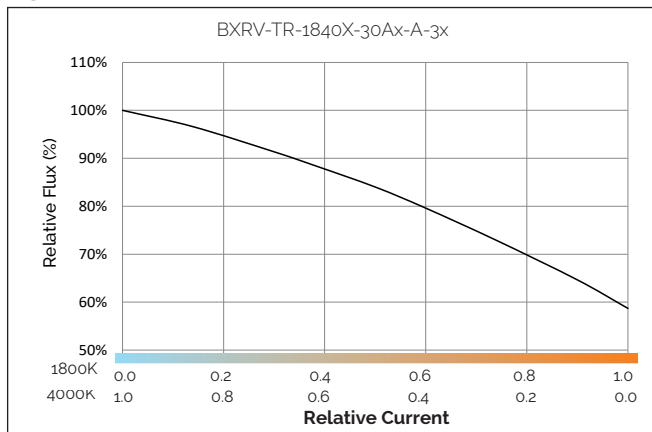
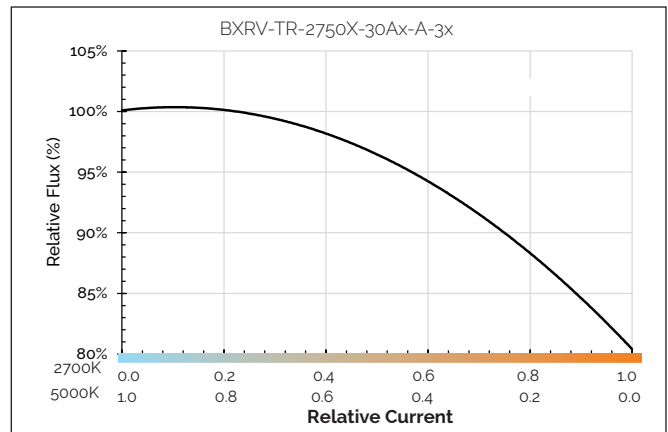
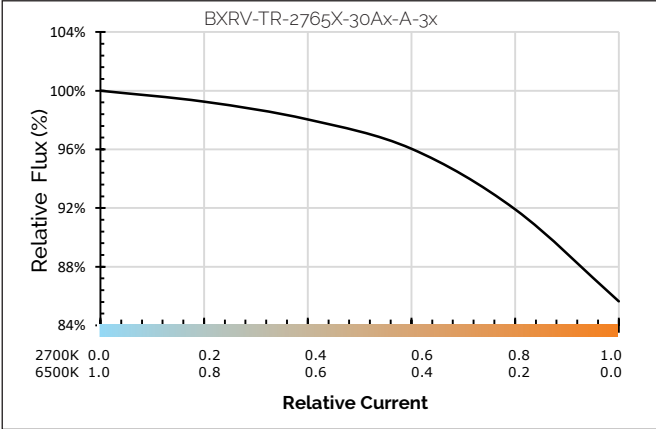

Figure 12: Relative Flux vs. Relative Current



Performance Curves

Figure13: Relative Flux vs. Relative Current



Typical Radiation Pattern

Figure 14: Typical Spatial Radiation Pattern

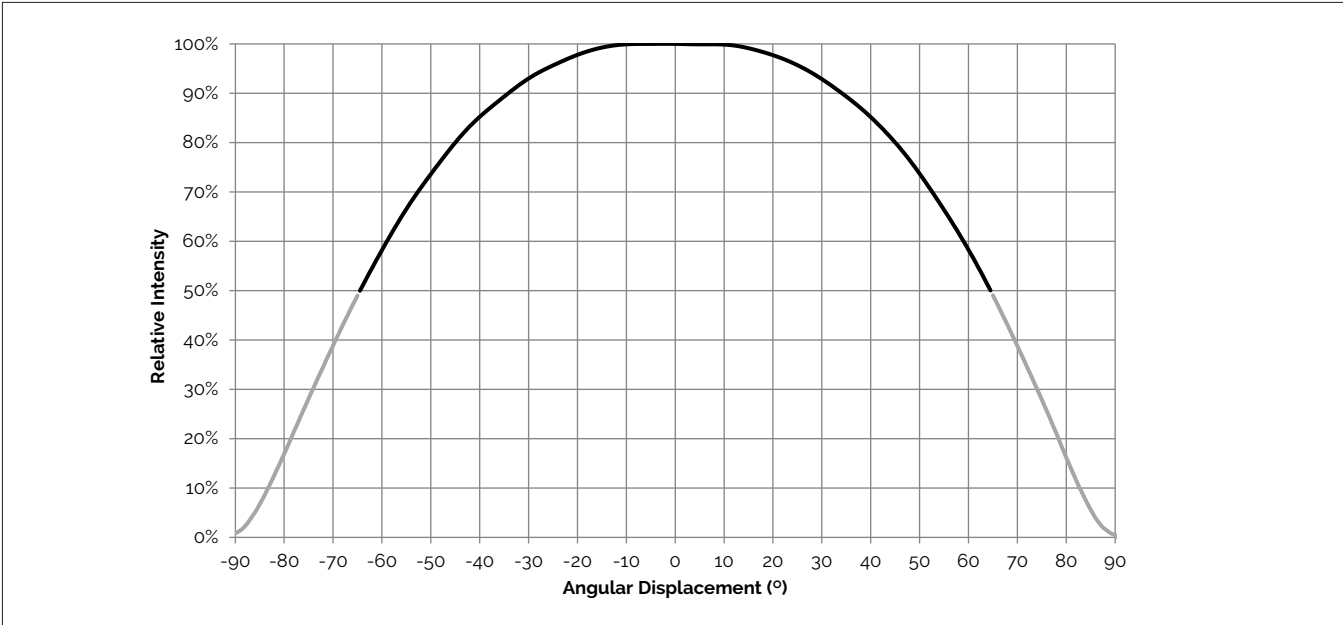

Notes for Figure 14:

- 1. Typical viewing angle is 130°.
- 2. The viewing angle is defined as the off axis angle from the centerline where I_v is ½ of the peak value.

Figure 15: Typical Polar Radiation Pattern

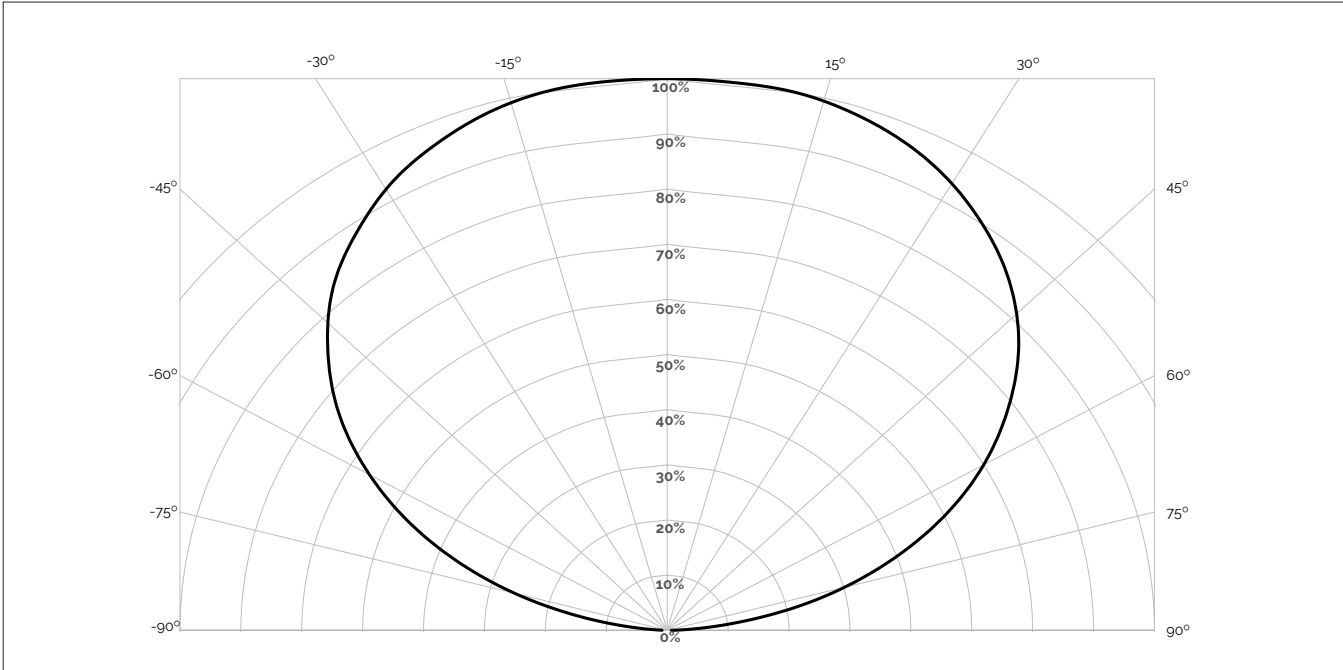

Typical Color Spectrum

Figure 16: 1800K - 4000K with 90 CRI , 85°C

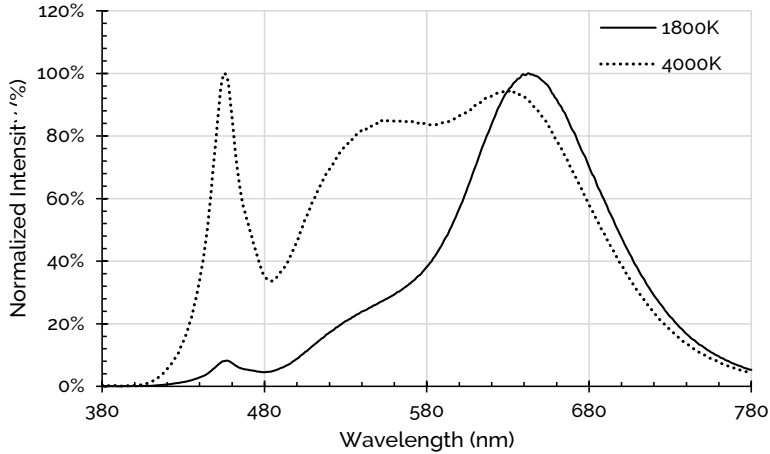

Note for Figure 16:

1. Color spectra measured at nominal current and $T_c = 85^\circ\text{C}$.

Figure 17: 2700K - 5000K with 90 CRI , 85°C

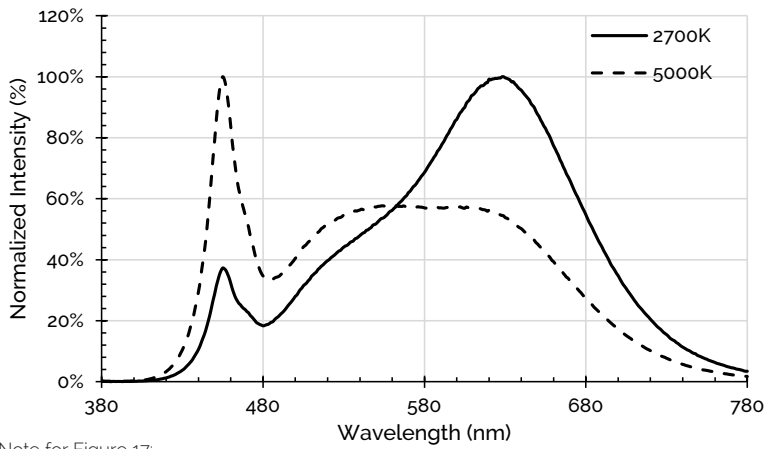

Note for Figure 17:

1. Color spectra measured at nominal current and $T_c = 85^\circ\text{C}$.

Figure 18: 2700K - 6500K with 90 CRI , 85°C

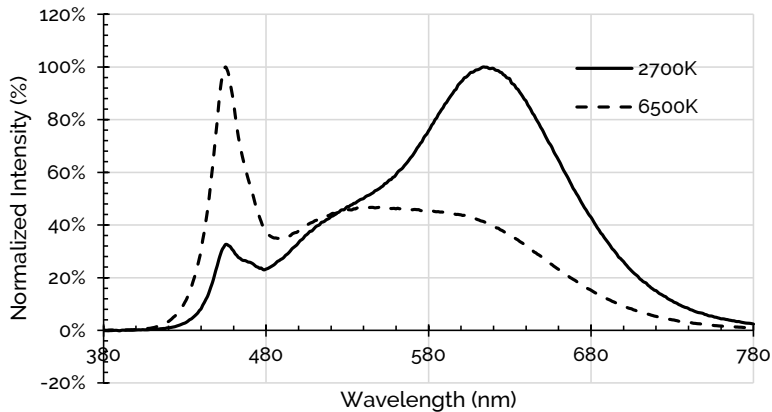

Note for Figure 18:

1. Color spectra measured at nominal current and $T_c = 85^\circ\text{C}$.

Mechanical Dimensions

Figure 19: Mechanical Drawing Specifications BXRV-TR-XXXXX-30Ax-A-3X

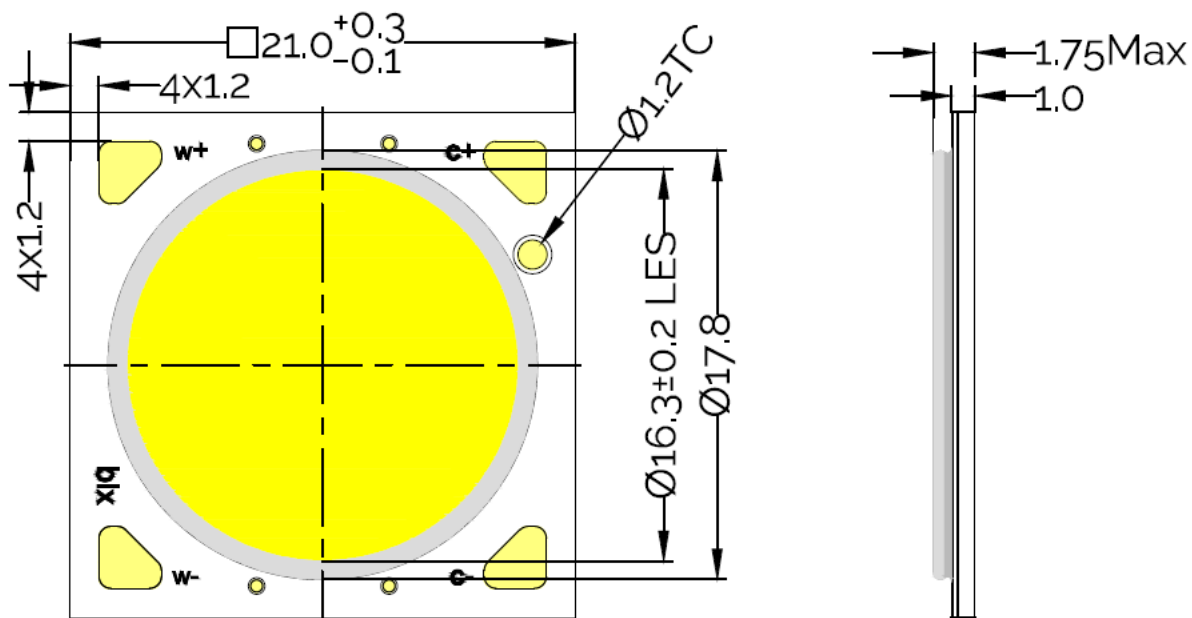

Notes for Figure 19:

1. Solder pads are labeled "+" to denote positive polarity and "-" to denote negative polarity. Solder pads have a gold surface finish.
2. Drawings are not to scale.
3. Drawing dimensions are in millimeters.
4. Unless otherwise specified, tolerances are $\pm 0.10\text{mm}$.
5. The optical center of the LED array is nominally defined by the mechanical center of the array.
6. Bridgelux maintains a flatness of 0.1 mm across the mounting surface of the array. Refer to Application Notes for product handling, mounting and heat sink recommendations.

Color Binning Information

Figure 20: Graph of Bins in xy Color Space, Tc=85°C

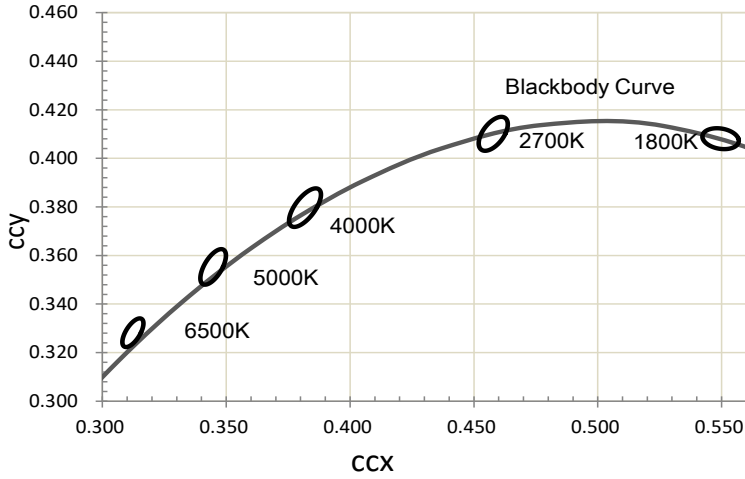

Table 5: McAdam ellipse CCT color bin definitions for product operating at T_c = 85°C

CCT	Center Point	Bin Size	Axis a	Axis b	Rotation Angle
1800K	x=0.5496 y= 0.4081	3 SDCM	0.00417	0.00741	80.00°
2700K	x=0.4578 y= 0.4101	3 SDCM	0.00810	0.00420	53.70°
4000K	x=0.3818 y=0.3797	3SDCM	0.00939	0.00402	53.72°
5000K	x=0.3447 y=0.3553	3 SDCM	0.00822	0.00354	59.62°
6500K	x=0.3123 y=0.3282	3 SDCM	0.00690	0.00285	58.57°

Notes for Table 5:

1. The x,y center points are the center points of the respective ANSI bins in the CIE 1931 xy Color Space
2. Products are binned at T_c=85°C
3. Bridgelux maintains a tolerance of +/-0.007 on x and y color coordinates in the CIE 1931 Color Space

Figure 21: Definition of the McAdam ellipse

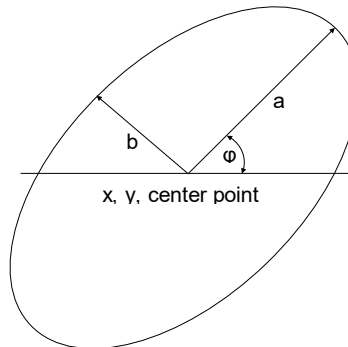

Packaging and Labeling

Figure 22: Vesta Series Tunable White Gen 3 15mm Packaging and Labeling

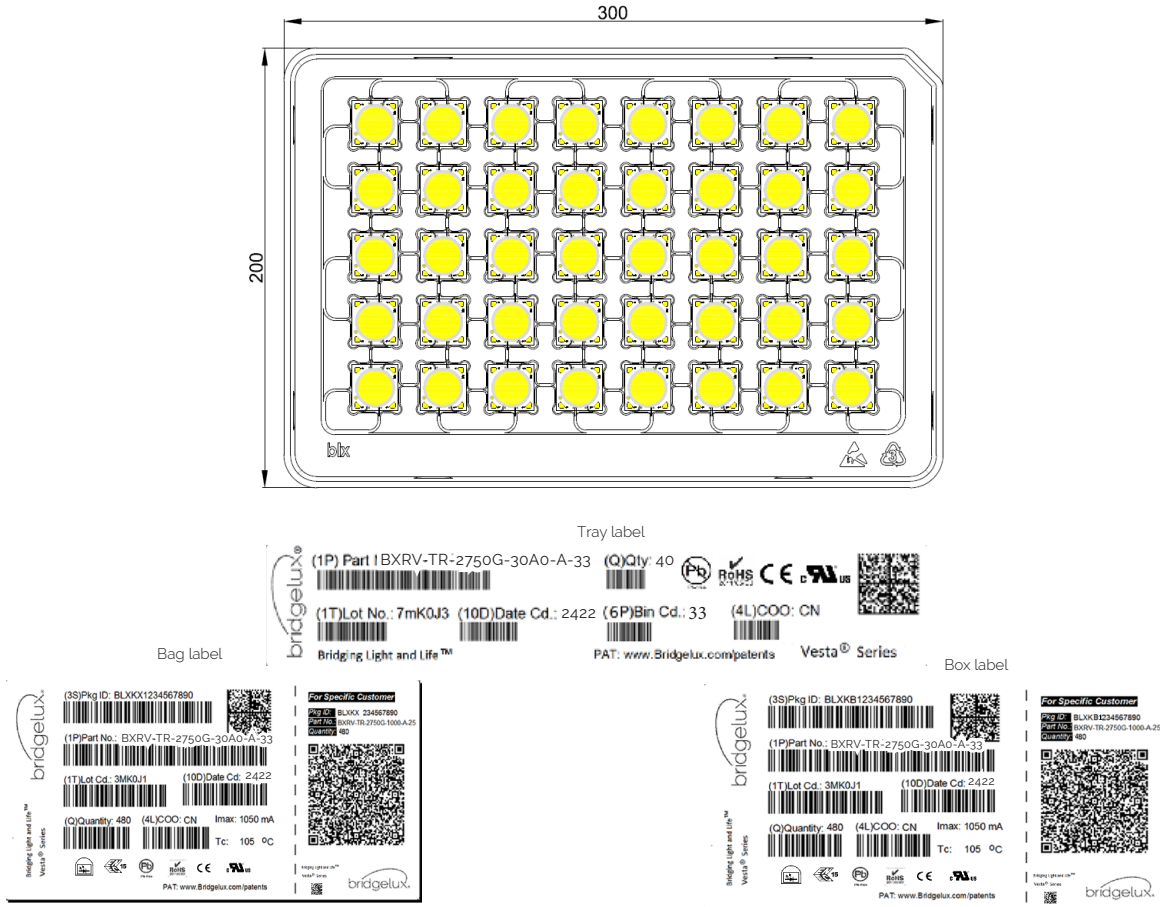

Notes for Figure 22:

1. Each tray holds 40 Vesta Series Tunable White 9mm arrays.
2. Eight trays and one cover tray are sealed in an anti-static bag. One such bag is placed in a box and shipped. The dimensions of such a box are 350mm x 245mm x 67 mm. The dimensions for an empty anti-static bag are 440mm (W) x 350mm (L) x 0.1 mm (T)
3. Depending on quantities ordered, a bigger shipping box, containing multiple boxes will be used to ship products.
4. Each bag and box is to be labeled as shown above.

Figure 23: Product Labeling

Bridgelux arrays have laser markings on the back side of the substrate to help with product identification. In addition to the product identification markings, Bridgelux arrays also contain markings for internal Bridgelux manufacturing use only. The image below shows which markings are for customer use and which ones are for Bridgelux internal use only. The Bridgelux internal manufacturing markings are subject to change without notice, however these will not impact the form, function or performance of the array.



Design Resources

Application Notes

Vesta Series Tunable White arrays are intended for use in dry, indoor applications. Bridgelux has developed a comprehensive set of application notes and design resources to assist customers in successfully designing with the Vesta Series product family of LED array products. For a list of resources under development, visit www.bridgelux.com.

Optical Source Models

Optical source models and ray set files are available for all Bridgelux products. For a list of available formats, visit www.bridgelux.com.

3D CAD Models

Three dimensional CAD models depicting the product outline of all Bridgelux Vesta Series LED arrays are available in both IGS and STEP formats. Please contact your Bridgelux sales representative for assistance.

LM80

Please contact your Bridgelux sales representative for more information.

Precautions

CAUTION: CHEMICAL EXPOSURE HAZARD

Exposure to some chemicals commonly used in luminaire manufacturing and assembly can cause damage to the LED array. Please consult Bridgelux Application Note for additional information.

CAUTION: EYE SAFETY

Eye safety classification for the use of Bridgelux Vesta Series is in accordance with IEC/TR62778 specification 'IEC 62471 for the assessment of blue light hazard to light source and luminaires'. Vesta Series Tunable White GEN3 arrays may be classified as Risk Group 2 when operated at or below the maximum drive current. Please use appropriate precautions. It is important that employees working with LEDs are trained to use them safely.

CAUTION: RISK OF BURN

Do not touch the Vesta Series LED array during operation. Allow the array to cool for a sufficient period of time before handling. The Vesta Series LED array may reach elevated temperatures such that could burn skin when touched.

CAUTION

CONTACT WITH LIGHT EMITTING SURFACE (LES)

Avoid any contact with the LES. Do not touch the LES of the LED array or apply stress to the LES (yellow phosphor resin area). Contact may cause damage to the LED array.

Optics and reflectors must not be mounted in contact with the LES (yellow phosphor resin area). Optical devices may be mounted on the top surface of the Vesta Series LED array. Use the mechanical features of the LED array housing, edges and/or mounting holes to locate and secure optical devices as needed.

Disclaimers

STANDARD TEST CONDITIONS

Unless otherwise stated, array testing is performed at the nominal drive current.

MINOR PRODUCT CHANGE POLICY

The rigorous qualification testing on products offered by Bridgelux provides performance assurance. Slight cosmetic changes that do not affect form, fit, or function may occur as Bridgelux continues product optimization.

About Bridgelux: Bridging Light and Life™

At Bridgelux, we help companies, industries and people experience the power and possibility of light. Since 2002, we've designed LED solutions that are high performing, energy efficient, cost effective and easy to integrate. Our focus is on light's impact on human behavior, delivering products that create better environments, experiences and returns—both experiential and financial. And our patented technology drives new platforms for commercial and industrial luminaires.

For more information about the company, please visit

bridgelux.com

twitter.com/Bridgelux

facebook.com/Bridgelux

youtube.com/user/Bridgelux

linkedin.com/company/bridgelux

WeChat ID: BridgeluxInChina



46410 Fremont Blvd
Fremont, CA 94538 USA
Tel (925) 583-8400
www.bridgelux.com

© 2025 Bridgelux, Inc. All rights reserved 2025. Product specifications are subject to change without notice. Bridgelux, the Bridgelux stylized logo design and Vesta are registered trademarks of Bridgelux, Inc. All other trademarks are the property of their respective owners.

Bridgelux Vesta Series Tunable White Gen 3 15mm Array Product Data Sheet DS496 Rev. B (01/2025)