



Bridgelux® Constant Voltage Single Channel 100~250W 1-10V Dimmable Slim Linear Driver

Product Data Sheet

Product Feature Map

Bridgelux Constant Voltage (1-10V) Single Channel 100-250W Driver provides constant output for LED modules and strips. This Driver allows for simple integration of Bridgelux's and all major brands White Arrays and LED strips. Please visit www.bridgelux.com for more information.



Product Nomenclature

The part number designation for Bridgelux Constant Voltage Single (1-10V) Channel 100W Driver is explained as follows:

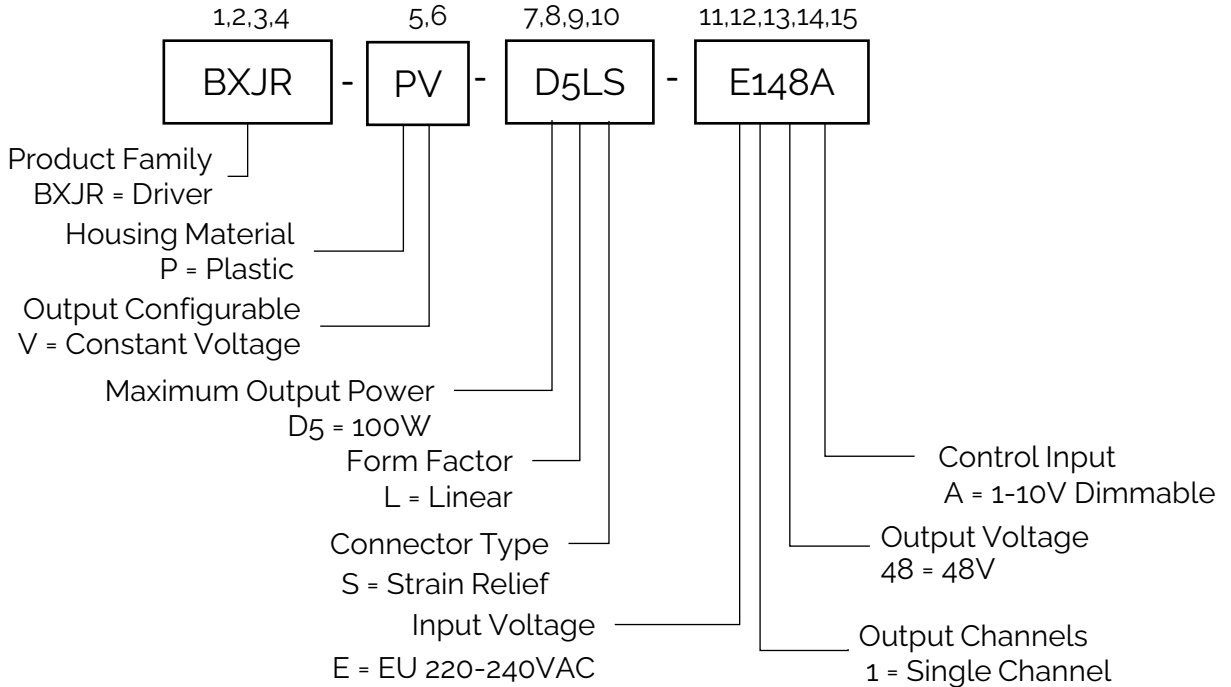

Electrical Characteristics

Table 1: Product Selection Guide

Part Number	Input Current	Input Power	Out Power Range	PF	Efficiency	Output Voltage	Output Current	No Load Voltage
BXJR-PV-H0LS-E148A	≤ 0.6A	≤ 115W	0-100W	≥ 0.95	92%	48V	0-2.1A	46.5-49.5V
BXJR-PV-H5LS-E148A	≤ 0.9A	≤ 168W	0-150W	≥ 0.95	92%	48V	0-3.125A	46.5-49.5V
BXJR-PV-D5LS-E148A	≤ 1.5A	≤ 275W	0-250W	≥ 0.95	93%	48V	0-5.21A	46.5-49.5V

*Test result @230 V, 50 Hz, Full Load

Table 2: Input Electrical Characteristics

Parameter	Unit	Specification		
		BXJR-PV-H0LS-E148A	BXJR-PV-H5LS-E148A	BXJR-PV-D5LS-E148A
Nominal voltage	V	220 – 240		
Nominal frequency	Hz	50 / 60		
AC voltage range	V	176 – 264		
DC voltage range	V	175-280		
Nominal current	A	0.6	0.9	1.5
Power factor (Full load)	-	≥ 0.95		
THD (Full load)	%	≤ 7		
Efficiency (Full load)	%	≥ 92	≥ 92	≥ 93
NO load	W	≤ 0.5		
Protection class	-	II		
Inrush current(Cold start)	A pk	< 45 (th = 250 μs)	< 56 (th = 185 μs)	< 76 (th = 310 μs)
Max. units per circuit breaker	-	B10: 13 B16: 21 C10: 21 C16: 34	B10: 11 B16: 17 C10: 17 C16: 27	B10: 8 B16: 13 C10: 13 C16: 20

Electrical Characteristics

Table 3: Output Electrical Characteristics

Parameter	Unit	Specification		
		BXJR-PV-H0LS-E148A	BXJR-PV-H5LS-E148A	BXJR-PV-D5LS-E148A
Nominal voltage range	V	47-49V		
Maximum voltage(Open Circuit)	Vdc	≤ 49.5		
Line Regulation	%	+/- 1		
Load Regulation	%	+/- 2		
Output voltage ripple	%	+/- 0.5		
Pst LM	-	≤ 1		
SVM	-	≤ 0.4		
Maximum power	W	100	150	250
Galvanic isolation: SELV	-	Output voltage of SELV controlgear not exceed limits in 10.4 of IEC61347-1		

Graphs of BXJR-PV-H0LS-E148A

Figure 1: Power Factor vs. Load

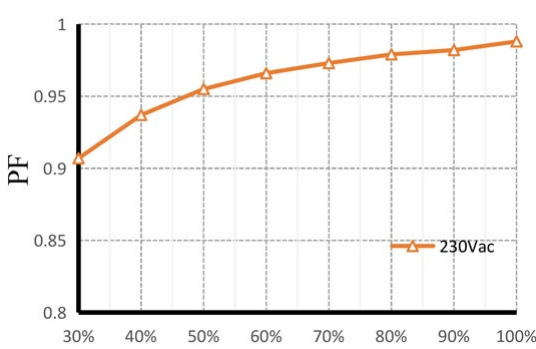

Figure 2: Total Harmonic Distortion vs. Load

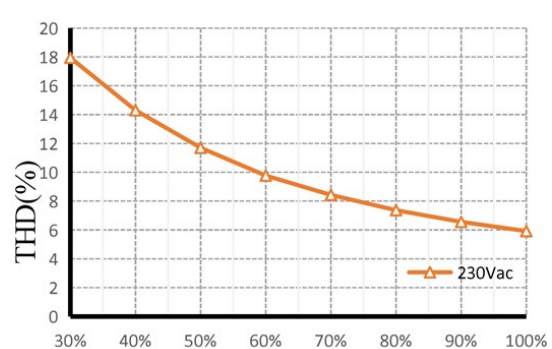

Figure 3: Efficiency vs. Load

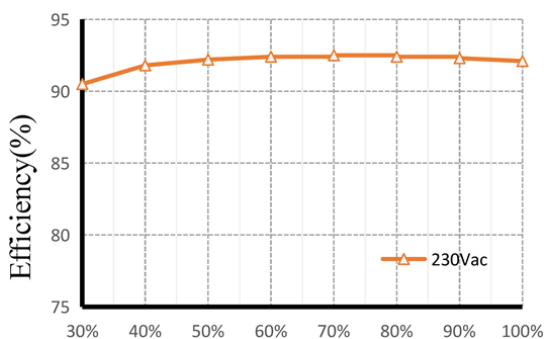
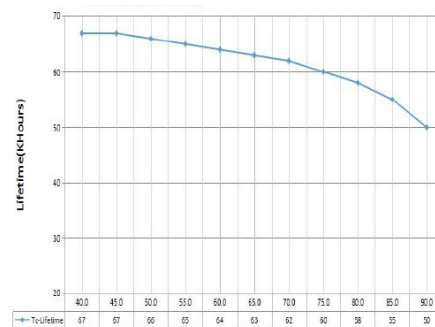

Figure 4: Expected Life Time



Electrical Characteristics

Graphs of BXJR-PV-H5LS-E148A

Figure 5: Power Factor vs. Load

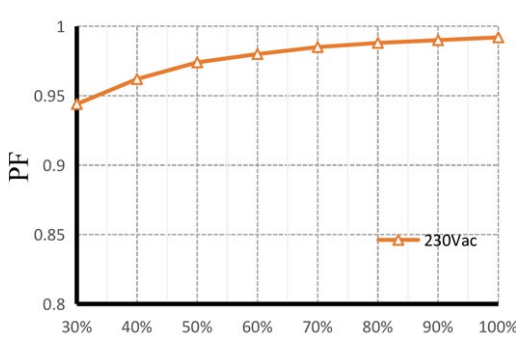

Figure 6: Total Harmonic Distortion vs. Load

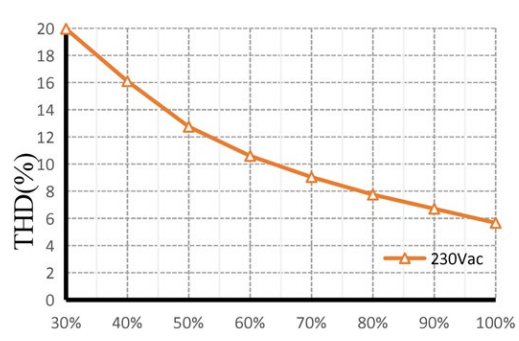

Figure 7: Efficiency vs. Load

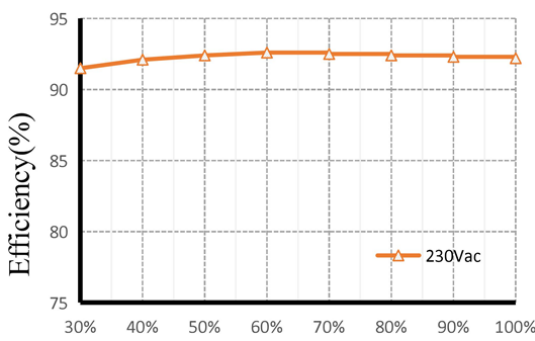
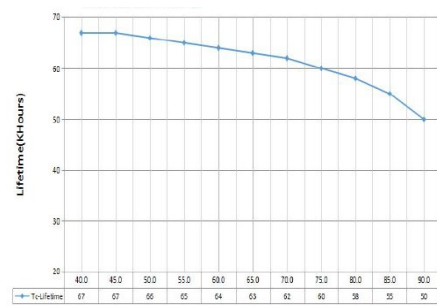

Figure 8: Expected Life Time



Graphs of BXJR-PV-D5LS-E148A

Figure 9: Power Factor vs. Load

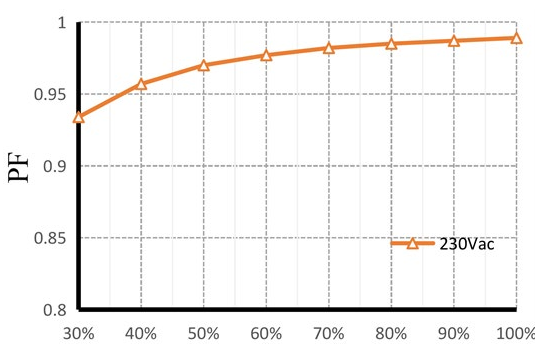

Figure 10: Total Harmonic Distortion vs. Load

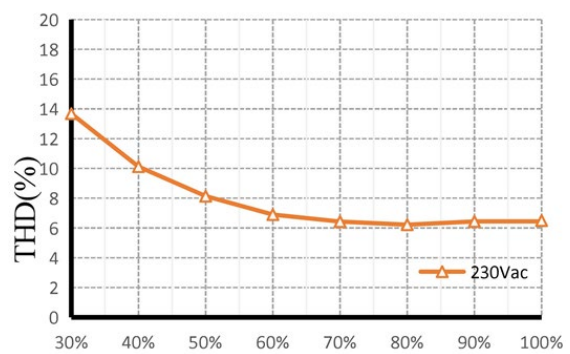

Figure 11: Efficiency vs. Load

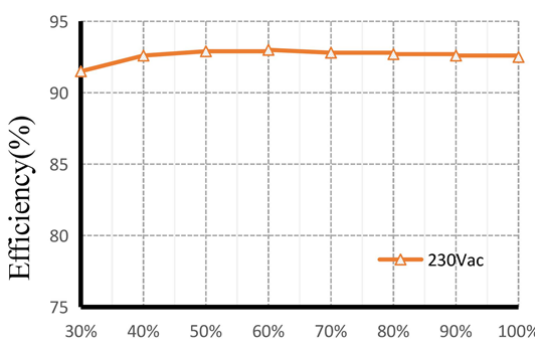
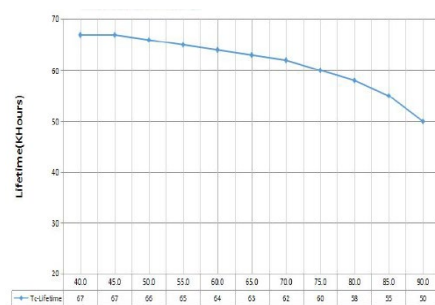

Figure 12: Expected Life Time



Electrical Characteristics

Table 4: 1-10V Dimming Control Characteristics

Parameter	Unit	Specification
Dim+,Dim-	-	The 1~10V/resistor/PWM dimming can be used to dim the output current via a standard commercial wall dimmer (0~10VDC) or an external control voltage source (0~10VDC) or external resistor or PWM signal
Dimming Curve	-	Linear (see "Dimming Curve")
Source Current on 0~10V Dimming Pin	-	Typical 100 μ A
Dimming Voltage for Full Bright	V	> 9.1V
External Resistor Value at Full Bright	Ω	100/N Kohm
PWM Signal	-	PWM Signal dimming Duty: 0- 99%,0.25KHz-2KHz, Voltage amplitude:3-10V
Output Dimming Range		Output duty:1%-100%, Dim-to-off

Figure 13: 1-10V Dimming Curve and Circuitry

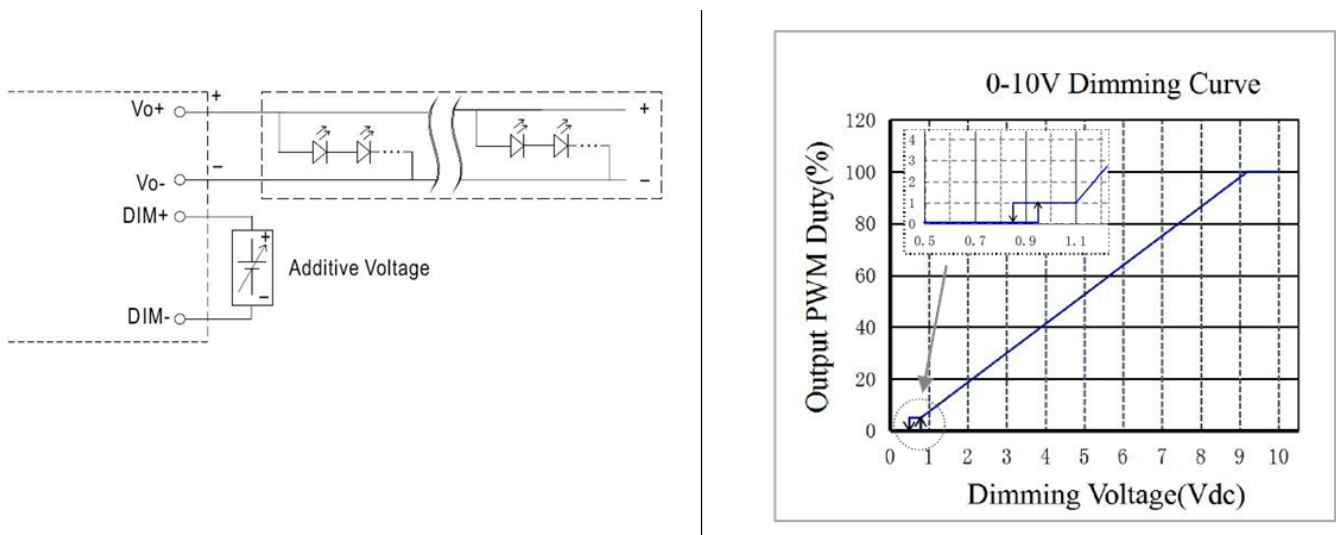

Electrical Characteristics

Figure 14: PWM Signal Dimming Curve and Circuitry

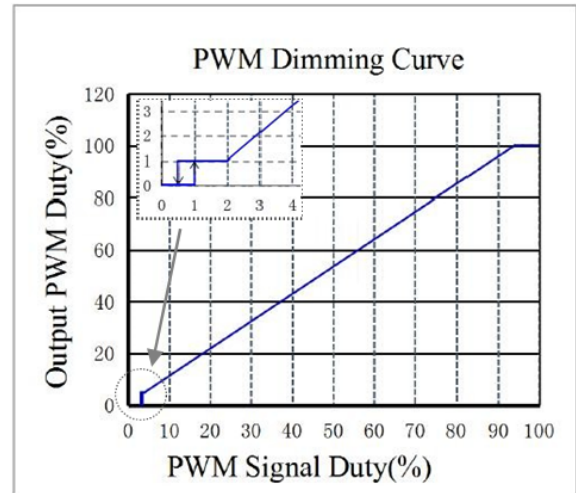
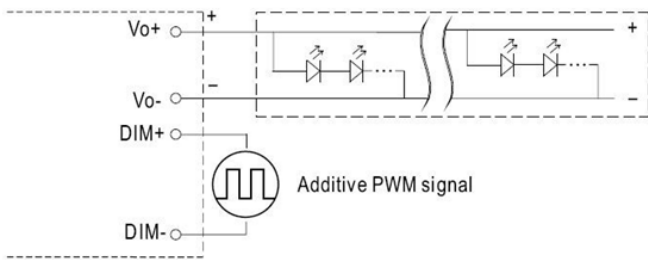
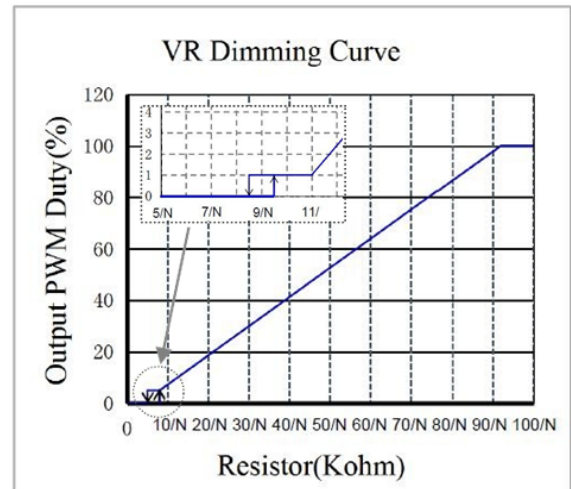
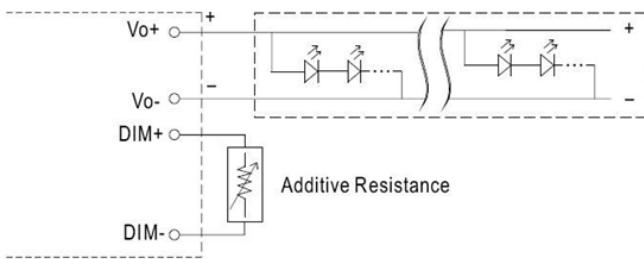

Figure 15: External Resistor Dimming Curve and Circuitry



(N=driver quantity for synchronized dimming operation)

Mechanical Characteristics

Table 5: Mechanical Data

Characteristics	Specification		
	BXJR-PV-H0LS-E148A	BXJR-PV-H5LS-E148A	BXJR-PV-D5LS-E148A
Dimensions	350 x 30 x 18 mm		400 x 40 x 22 mm
Enclosure Materials	PC Plastic		
Weight	184g	281g	502g
Ingress Protection	IP20		

Figure 16: Mechanical Drawing

BXJR-PV-H0LS-E148A & BXJR-PV-H5LS-E148A :

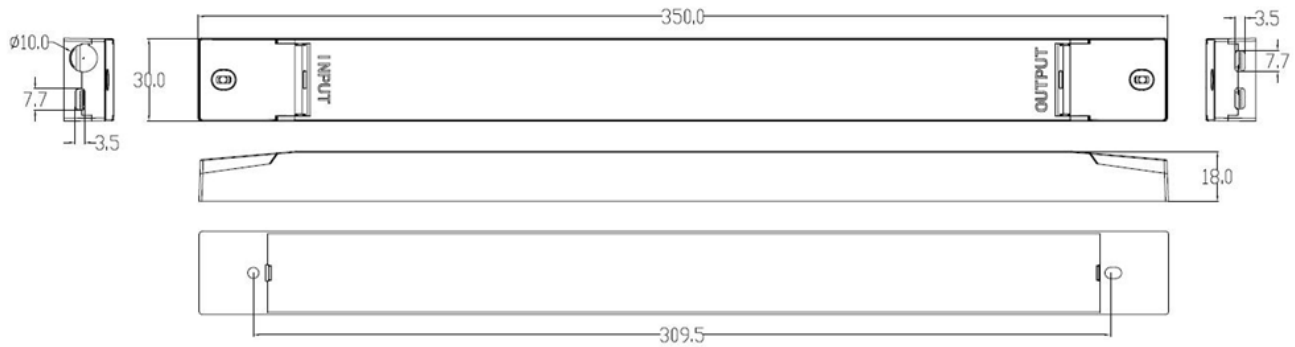

Mechanical Characteristics

BXJR-PV-D5LS-E148A:

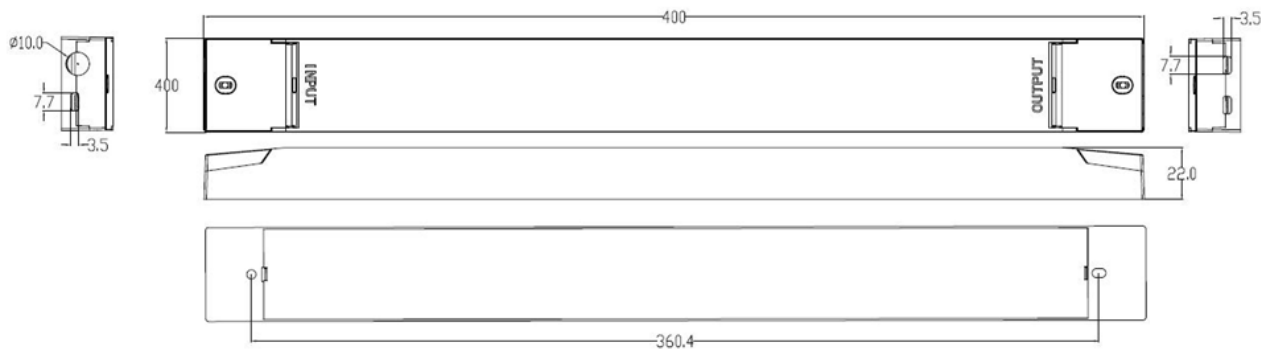

Notes for Figure 17:

1. Drawing dimensions are in millimeters
2. Unless otherwise specified, all linear tolerances are ± 1.0 mm

Wiring Diagram

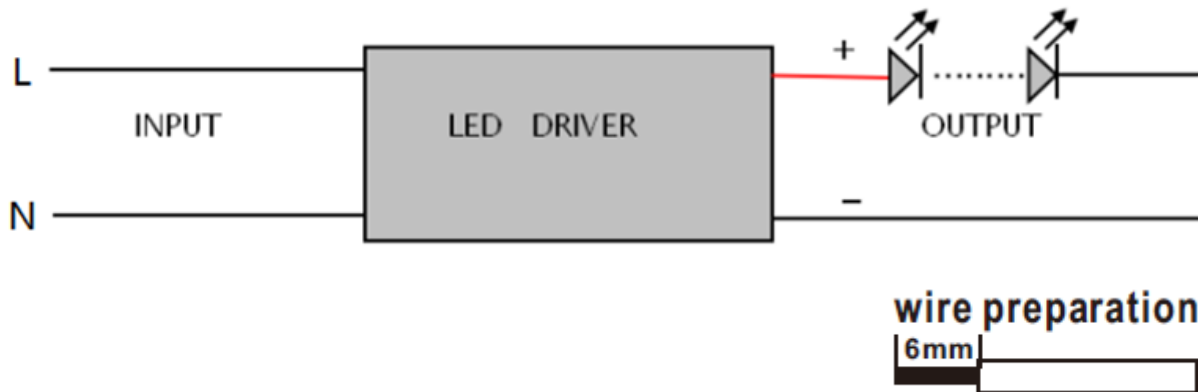

Table 6: [Wiring of BXJR-PV-H0LS-E148A & BXJR-PV-H5LS-E148A](#)

PRI		
PRI/DIM	Cable cross-section	0.75 – 1.5 mm ² / AWG 18 - 15
	Stripping	6 mm
SEC	Cable cross-section	0.75 – 1.5 mm ² / AWG 18 - 15
	Stripping	6 mm

Table 7: [Wiring of BXJR-PV-D5LS-E148A](#)

PRI		
PRI/DIM	Cable cross-section	0.75 – 1.5 mm ² / AWG 18 - 15
	Stripping	6 mm
SEC	Cable cross-section	2 x 0.75 – 1.5 mm ² / AWG 18 - 15
	Stripping	6 mm

Notes for Table 6/7:

- Hot plug-in or secondary switching of LEDs is not permitted and may cause a very high current to the LEDs.
- Unless otherwise specified, all linear tolerances are +/-1.0mm

Environmental and Regulatory Standards

Table 8: Environmental Conditions

Parameter	Specification
Ambient Operating Temperature	-25°C to + 45°C
Max. Case Temperature Tc	+90°C
Max. Case Temperature (In fault condition)	+100°C
Humidity Rating	Maximum 85% Relative Humidity, non condensing
Storage Temperature	-40°C to + 85°C
Expected Lifetime	50,000 hours (Tc < 90°C)

Table 9: Regulatory Approvals and Compliance

Specification	Reference Standard	Condition
DC or AC supplied electronic controlgear for LED modules	EN 62384	electronic controlgear for use on DC or AC supplies up to 1 000 V (alternating current at 50 Hz or 60 Hz) and with an output frequency which can deviate from the supply frequency
Conducted and Radiated EMI	EN 55015:2019+A1:2020 (CISPR 15:2018)	
Harmonic Current Emissions	EN IEC 61000-3-2:2019	
Voltage Fluctuations & Flicker	IEC 61000-3-3:2013+A1:2019	
ESD (Electrostatic Discharge)	IEC 61547:2009 Section 5.2 Test des.: IEC 61000-4-2	4 kV contact discharge, 8 kV air discharge, level 3
Continuous Radiated Disturbance	IEC 61547:2009 Section 5.3 Test des.: IEC 61000-4-3	3 V/m, 80 - 1000 MHz, 80% modulated at distance of 3 meters
Electrical Fast Transient	IEC 61547:2009 Section 5.5 Test des.: IEC 61000-4-4	± 1 kV on AC power port for 1 minute,
Surge	IEC 61547 Section 5.7 Test des.: IEC 61000-4-5	± 1 kV (differential mode) ± 2 kV (common mode)
Continuous Conducted Disturbance	IEC 61547:2009 Section 5.6 Test des.: IEC 61000-4-6	3V, 0.15-80 MHz, 80% modulated, Level 2
Voltage Dips	IEC 61547 Section 5.8, 5.9 Test des.: IEC 61000-4-11	70% dip during 25 cycles @ 50Hz, 30 cycles @ 60Hz 0% dip during ½ cycles
Touch Current	EN60598-1	lower than 0.7 mA, according to EN 60598-1 annex. G and EN 61347-1 annex A

Regulatory Standards (continued)

Table 10: Safety Agency Approvals

Specification	Reference Standard	Condition
ENEC / CE / UKCA	EN 61347-1:2015, EN 61347-2-13:2014+A1	
Glow wire test	EN 61347-1:2015	Passed with increased temperature at 850°C

Protection

Table 11: Protection

Parameters	Specification
Over Load Protection	Yes / Auto Resume
Over Voltage Protection	Yes / Auto Resume
Short Circuit Protection	Yes / Auto Resume

Packaging

Table 12: Packaging Box Configuration

Parameters	Specification		
	BXJR-PV-HoLS-E148A	BXJR-PV-H5LS-E148A	BXJR-PV-D5LS-E148A
Driver quantity	40 pcs		25
Outer dimensions	440X 345 X 155 mm		440X 300 X 155 mm
Weight	7.89 kg	11.75 kg	13 kg

Design Resources

Application Notes

Please contact your Bridgelux sales representative for assistance on obtaining application support when designing with the Bridgelux Constant Voltage Single Channel Driver. For a list of available resources, visit www.bridgelux.com.

Precautions

CAUTION: PRODUCT HANDLING

Handle the Constant Voltage (1-10V) Single Channel Driver with care to prevent any damage from mechanical shock. It is recommended to handle this driver in a static-free environment

Do not open or disassemble the product

To maintain product warranty, the installer is responsible for ensuring that the driver's operating conditions do not exceed the maximum conditions stated within this data sheet

CAUTION: PRODUCT INSTALLATION

Incorrect installation of the Constant Voltage Single (1-10V) Channel Driver can cause irreparable damage to the driver, connected LEDs.

Pay attention when connecting the LED load and observe the correct polarity of the output terminals as specified in this data sheet and on the driver label.

CAUTION: ELECTRIC SHOCK

Be aware of the possibility of an electric shock hazard which can result in serious injury or death. Disconnect power before servicing or installing this device.

Disclaimers

MINOR PRODUCT CHANGE POLICY

The rigorous qualification testing on products offered by Bridgelux provides performance assurance. Slight cosmetic changes that do not affect form, fit, or function may occur as Bridgelux continues product optimization.

About Bridgelux: Bridging Light and Life™

At Bridgelux, we help companies, industries and people experience the power and possibility of light. Since 2002, we've designed LED solutions that are high performing, energy efficient, cost effective and easy to integrate. Our focus is on light's impact on human behavior, delivering products that create better environments, experiences and returns—both experiential and financial. And our patented technology drives new platforms for commercial and industrial luminaires.

For more information about the company, please visit

bridgelux.com

twitter.com/Bridgelux

facebook.com/Bridgelux

youtube.com/user/Bridgelux

linkedin.com/company/bridgelux

WeChat ID: BridgeluxInChina



46410 Fremont Blvd

Fremont, CA 94538 USA

Tel (925) 583-8400

www.bridgelux.com