



Bridgelux® Vesta-W4 Quad Channel 30W (Wiz) Compact Round Driver

Product Data Sheet DS1231

Product Feature Map

Bridgelux Vesta-W4 (Wiz) Quad Channel 30W Driver provides dynamic constant current output for LED modules and arrays. This Driver interoperates with Wiz control lighting systems and protocols and allows for simple integration of Bridgelux's RGBW and 3CCT White Arrays and Linear modules. Please visit www.bridgelux.com for more information.



Product Nomenclature

The part number designation for Bridgelux Vesta-W4 (Wiz) Quad Channel 30W Driver is explained as follows:

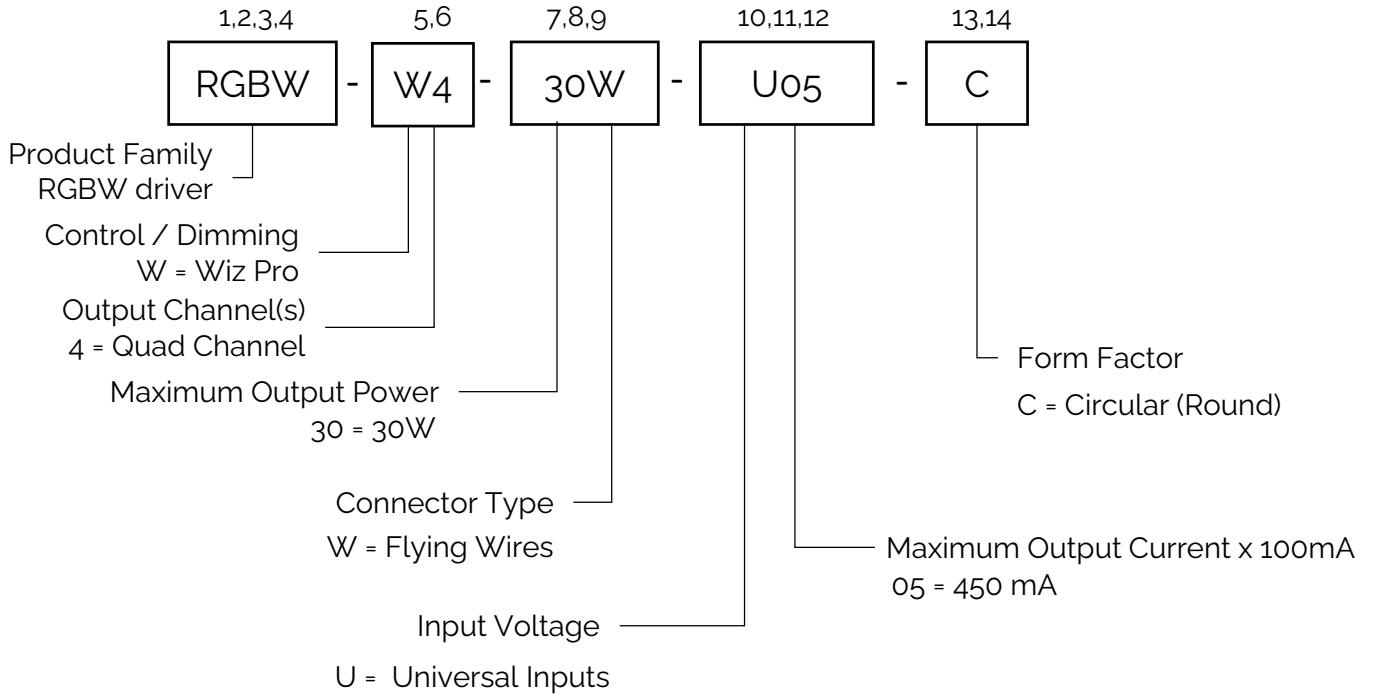

Table 1: Product Selection Guide

Part Number	Configuration
RGBW-W4-30W-U05-C	Circular 4 Channel Driver, US 120 - 277VAC

Wiring and setup instructions

Bridgelux Vesta-W4 driver can power up various Bridgelux 4 Channels LEDs (RGBW series). Below table provides some examples of the driver channel mapping to different LEDs channels (further instructions please contacts Bridgelux).



- All Ch + (Purple)
- W - (Yellow)
- R - (Red)
- G - (Green)
- B - (Blue)

Driver Channel	LED Channel			
	Array (COB) RGBW (CRI 95)	SMD RGBW (CRI 95)	SMD 3CCT (CRI 90)	SMD 3CCT (CRI 97)
R-	Red	Red	1	1
G-	Green	Green	1	2
B-	Blue	Blue	2	3
W-	White	White	3	3

Similar to hardware wiring (different configurations) , Bridgelux Vesta-W4 driver comes with different firmware for various LEDs control parameters.

After driver setup in Wiz Pro apps, user can find the corresponding Wiz Model IDs.

Wiz Pro Model IDs			
Array (COB) RGBW (CRI 95)	SMD RGBW (CRI 95)	SMD 3CCT (CRI 90)	SMD 3CCT (CRI 97)
124014	TBD	TBD	TBD

User should inform Bridgelux which Wiz pro Model ID is needed (when ordering); the correct firmware can be loaded prior for product shipment.

Please note: if needed, Bridgelux Vesta-W4 driver can change from one Model ID to another; different Model ID firmware can be loaded OTA via the Wiz app.

User just need to report the driver MAC address (the unique QR code sticker at the side of each driver)

Ordering example:

PN: RGBW-W4-30W-U05-C (Remarks: Model ID: 124014)

Electrical Characteristics

Table 2: Input Electrical Characteristics

Parameter	Unit	Specification
Nominal voltage	V	120 / 220 – 240 / 277
Nominal frequency	Hz	50 / 60
AC voltage range	V	108 – 305
DC voltage range	V	NA
Nominal current (Max)	A	0.35A @120V 0.20A @230V 0.18A @277V
Power factor (Full load)	-	≥ 0.95 @120V ≥ 0.95 @230V ≥ 0.90 @277V
THD (Full load)	%	≤ 20
Efficiency (Full load)	%	≥ 82
NO load	W	≤ 0.5
Protection class	-	I, II

Table 3: Output Electrical Characteristics

Parameter	Unit	Specification
Nominal voltage range	V	29-39V
Maximum voltage (Open Circuit)	Vdc	≤ 59
Nominal current	mA	Ch 1 Red 300 mA Ch 2 Green 300 mA Ch 3 Blue 300 mA Ch 4 White 450 mA Combined (4 Channel) = 750 mA max.
Current accuracy	%	+/- 5
Dimming		Wiz Pro (Wireless)
Dimming Range		10% - 100%
Current ripple LF < 20MHz	%	≤ 30
Pst LM	-	≤ 1.0
SVM	-	≤ 0.4
Maximum power	W	30
Galvanic isolation	-	SELV

Electrical Characteristics

Figure 1: Operating Window

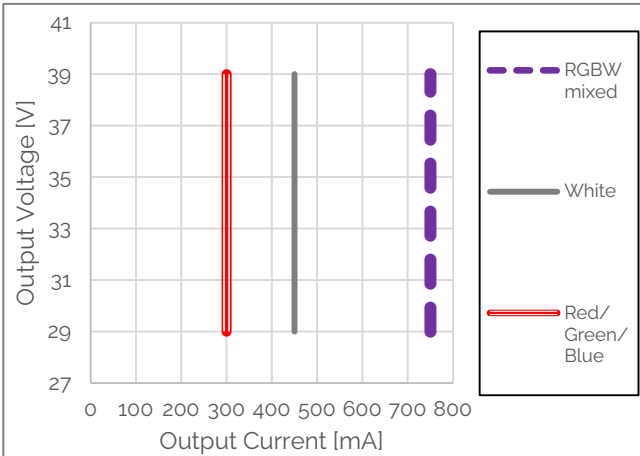

Figure 2: Power Factor vs. Output Power

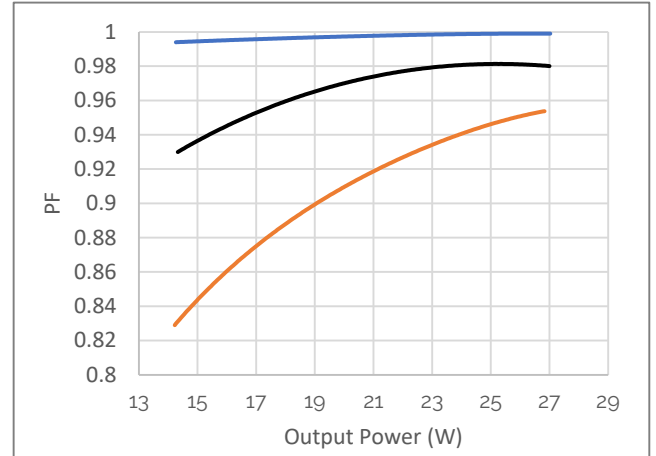

Figure 3: THDi vs Output Power

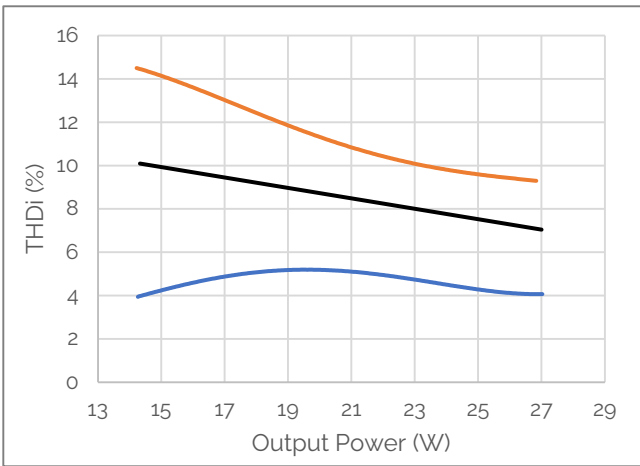

Figure 4: Input Current vs Output Power

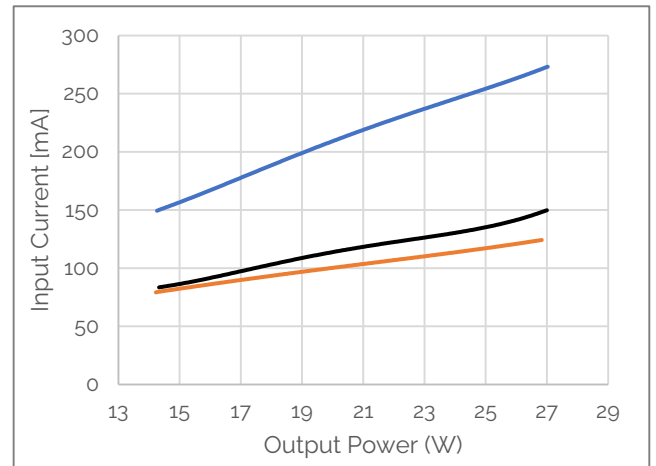
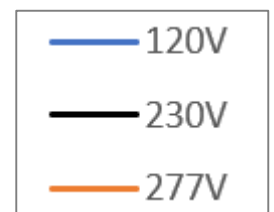
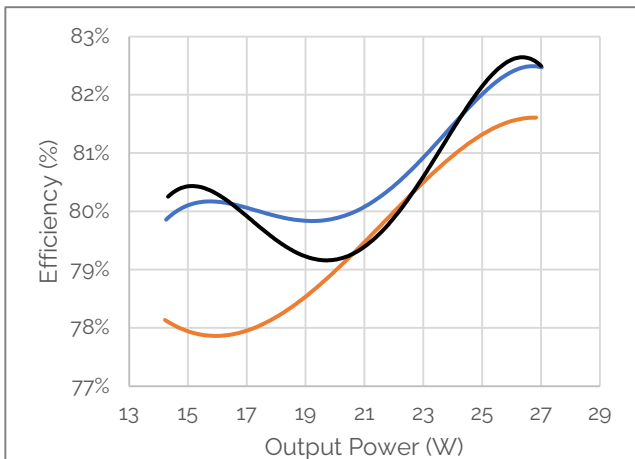

Figure 5: Efficiency vs Output Power



Mechanical Characteristics

Table 4: Product Selection Guide

Characteristics	Specification
Dimensions	Ø 75 x 25 mm
Enclosure Materials	PC Plastic
Weight	174
Ingress Protection	IP65

Figure 5: Mechanical Drawing

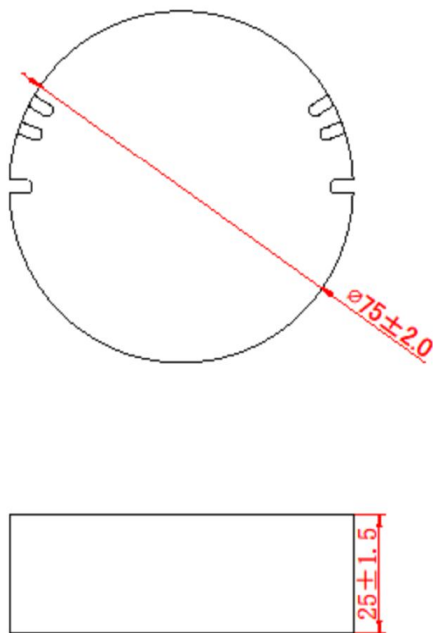

Notes for Figure 5:

1. Drawing dimensions are in millimeters
2. Unless otherwise specified, all linear tolerances are ± 1.0 mm.

Wiring & Connections

Table 6: Wiring

	Specification item	Value
PRI	Cable cross-section	1.5 mm ² / AWG 18
	Length	152 mm
SEC	Cable cross-section	0.25 mm ² / AWG 24
	Length	152 mm

Notes for Table 6:

1. Unless otherwise specified, all linear tolerances are +/-1.0mm

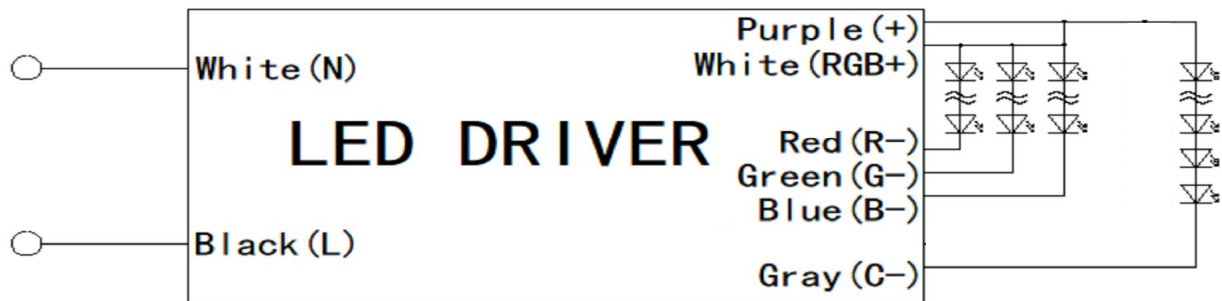

Driver Programmed Output Current

Table 7: Pre-programmed Output Current (per channel, match to BXRV-D13-RGBW3000-A3)

Part Number	Nominal CCT ¹ (K)	CRI ²	Nominal Drive Current Per Channel (mA)				Forward Voltage ⁴ (V)				Typical DC Flux ³ ₅₋₆ (lm)	Typical Power (W)	Typical Efficacy (lm/W)
			White	Red	Green	Blue	White	Red	Green	Blue			
BXRV-D13-RGBW3000-A3	1800	86	190	300	0	0	33.2	33.7	0.0	0.0	1224	16.4	75
	2200	93	230	300	27	1	33.5	33.7	31.2	29.4	1587	18.7	85
	2700	95	315	274	69	12	34.2	33.6	31.9	30.3	2211	22.5	98
	3000	95	282	275	93	20	34.0	33.6	32.2	30.6	2249	22.4	100
	3500	95	258	255	125	32	33.8	33.4	32.5	30.9	2355	22.3	106
	4000	95	272	196	155	47	33.9	33.0	32.9	31.2	2566	22.2	115
	5000	95	222	176	200	72	33.5	32.8	33.3	31.5	2604	22.1	118
	5700	95	207	153	222	88	33.3	32.6	33.5	31.7	2638	22.1	119
	6500	95	245	87	230	108	33.7	31.9	33.5	32.0	2782	22.2	125

Environmental and Regulatory Standards

Table 8: Environmental Conditions

Parameter	Specification
Ambient Operating Temperature	-20°C to + 50°C
Max. Case Temperature Tc	+90°C (max)
Humidity Rating	Maximum 90% Relative Humidity, non condensing
Storage Temperature	-40°C to + 80°C
Expected Lifetime	> 50,000 hours (Tc < 90°C)

Table 9: Regulatory Approvals and Compliance

Specification	Reference Standard	Condition
Conducted and Radiated EMI	US: FCC Title 47 Part 15B EU: EN 55015:2013 (CISPR 15:2013)	US: Class B at 120VAC, Class A at 277VAC
Harmonic Current Emissions	EN IEC 61000-3-2:2014	
Voltage Fluctuations & Flicker	IEC 61000-3-3:2013	
ESD (Electrostatic Discharge)	IEC 61547:2009 Section 5.2 Test des.: IEC 61000-4-2	2 kV contact discharge, 4 kV air discharge, level 3
Continuous Radiated Disturbance	IEC 61547:2009 Section 5.3 Test des.: IEC 61000-4-3	3 V/m, 80 - 1000 MHz, 80% modulated at distance of 3 meters
Electrical Fast Transient	IEC 61547:2009 Section 5.5 Test des.: IEC 61000-4-4	± 1 kV on AC power port for 1 minute,
Surge	IEC 61547 Section 5.7 Test des.: IEC 61000-4-5	± 1 kV (differential mode)
Continuous Conducted Disturbance	IEC 61547:2009 Section 5.6 Test des.: IEC 61000-4-6	3V, 0.15-80 MHz, 80% modulated, Level 2
Voltage Dips	IEC 61547 Section 5.8, 5.9 Test des.: IEC 61000-4-11	70% dip during 25 cycles @ 50Hz, 30 cycles @ 60Hz 0% dip during ½ cycles

Regulatory Standards (continued)

Table 10: Safety Agency Approvals

Specification	Reference Standard	Condition
UL / cUL	UL8750, CAN/CSA-C22.2 No. 250.13	
CE / UKCA	EN 61347-1:2015, EN 61347-2-13:2014/A1:2017	

Table 11: Wireless Standards / Parameters

Specification	Reference Standard / Parameters	Condition
Work Mode	Wi-Fi: 802.11b/g BLE: Bluetooth 4.2	
RF Output Power	Wi-Fi: 20 dBm BLE: 8 dBm	
Work Frequency	Wi-Fi: 2.4 - 2.4835 GHz BLE: 2.4 - 2.4835 GHz	



Protection

Table 12: Protection

Parameters	Specification
Over Load Protection	Yes / Auto Resume
Short Circuit Protection	Yes / Auto Resume

Design Resources

Application Notes

Please contact your Bridgelux sales representative for assistance on obtaining application support when designing with the Bridgelux Vesta-W4 Quad Channel Driver. For a list of available resources, visit www.bridgelux.com.

Precautions

CAUTION: PRODUCT HANDLING

Handle the Vesta-W4 Quad Channel Driver with care to prevent any damage from mechanical shock. It is recommended to handle this driver in a static-free environment. To maintain product warranty, the product must not be opened or disassembled and the installer must ensure that the driver's operating conditions do not exceed the maximum conditions stated within this data sheet.

CAUTION: PRODUCT INSTALLATION

Incorrect installation of the Vesta-W4 Quad Channel Driver can cause irreparable damage to the driver, connected LEDs. Pay attention when connecting the LED load and observe the correct polarity of the output terminals as specified in this data sheet and on the driver label. Hot plug-in or secondary switching of LEDs is not permitted and may cause a very high current to the LEDs.

CAUTION: ELECTRIC SHOCK

Be aware of the possibility of an electric shock hazard which can result in serious injury or death. Disconnect power before servicing or installing this device.

Disclaimers

MINOR PRODUCT CHANGE POLICY

The rigorous qualification testing on products offered by Bridgelux provides performance assurance. Slight cosmetic changes that do not affect form, fit, or function may occur as Bridgelux continues product optimization.

About Bridgelux: Bridging Light and Life™

At Bridgelux, we help companies, industries and people experience the power and possibility of light. Since 2002, we've designed LED solutions that are high performing, energy efficient, cost effective and easy to integrate. Our focus is on light's impact on human behavior, delivering products that create better environments, experiences and returns—both experiential and financial. And our patented technology drives new platforms for commercial and industrial luminaires.

For more information about the company, please visit

bridgelux.com

twitter.com/Bridgelux

facebook.com/Bridgelux

youtube.com/user/Bridgelux

linkedin.com/company/bridgelux

WeChat ID: BridgeluxInChina



46410 Fremont Blvd

Fremont, CA 94538 USA

Tel (925) 583-8400

www.bridgelux.com