



Bridgelux® V10 F90 Array Series

Product Data Sheet DS446-3



Introduction

V Series



The V Series™ LED Array products deliver high quality light in a compact and cost-effective solid-state lighting package. These chip on board (CoB) arrays can be efficiently driven up to two times the nominal drive current, enabling design flexibility not previously possible. These high flux density light sources are designed to support a wide range of high quality, low cost directional luminaires and replacement lamps for both interior and exterior commercial and residential applications.

The F90 V Series COB is a high efficacy product that uses narrow band red phosphor to significantly improve the spectrum efficacy. The improved spectrum efficacy results in the 90 CRI product of the F90 Series delivering better or equivalent efficacy as that of our traditional 80 CRI V Series product.

The V10 LED Array is available in a variety of electrical, CCT, and CRI combinations providing substantial design flexibility and energy efficiency advantages.

Lighting system designs incorporating these LED arrays deliver increased system level efficacy and a longer service life. Typical applications include replacement lamps and task, accent, spot, track, wide area, security, wall packs and down lights.

Features

- Efficacy of 176 lm/W typical, 3000K 90 CRI
- Wide selection of CCT options (2700K-5000K) with minimum 90 CRI options
- Uniform high-quality illumination
- 2 and 3 SDCM binning options (2700K – 4000K)
- Forward voltage bin codes and backside marking
- Instant light with unlimited dimming
- 5-Year warranty

Benefits

- Enables high efficiency lighting systems and lower operating costs
- Supports the trend toward luminaire miniaturization and delivers enhanced optical control
- Design flexibility for a broad range of lighting applications
- Clean white light without pixelation
- Uniform consistent white light
- Design flexibility for multi-source applications
- Easy to use with daylight and motion sensors to increase energy savings
- Design with confidence



Contents

Product Feature Map	2
Product Nomenclature	2
Product Selection Guide	3
European Product Registry for Energy Labeling	5
Performance at Commonly Used Drive Currents	6
Electrical Characteristics	8
Eye Safety	9
Absolute Maximum Ratings	10
Performance Curves	11
Typical Radiation Pattern	13
Typical Color Spectrum	14
Mechanical Dimensions	15
Color Binning Information	16
Packaging and Labeling	17
Design Resources	19
Precautions	19
Disclaimers	19
About Bridgelux	20

Product Feature Map

Bridgelux arrays are fully engineered devices that provide consistent thermal and optical performance on an engineered mechanical platform. The V Series arrays are the most compact chip-on-board devices across all of

Bridgelux's LED Array products. The arrays incorporate several features to simplify design integration and assembly. Please visit www.bridgelux.com for more information on the V Series family of products.

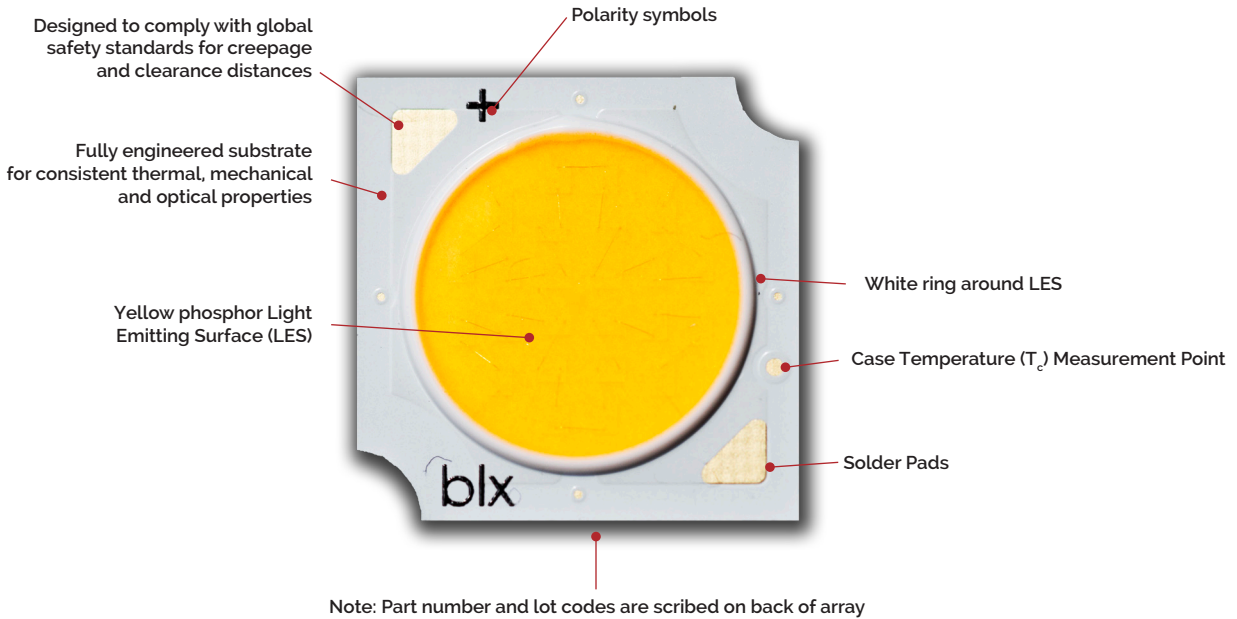

Product Nomenclature

The part number designation for Bridgelux V Series LED arrays is explained as follows:

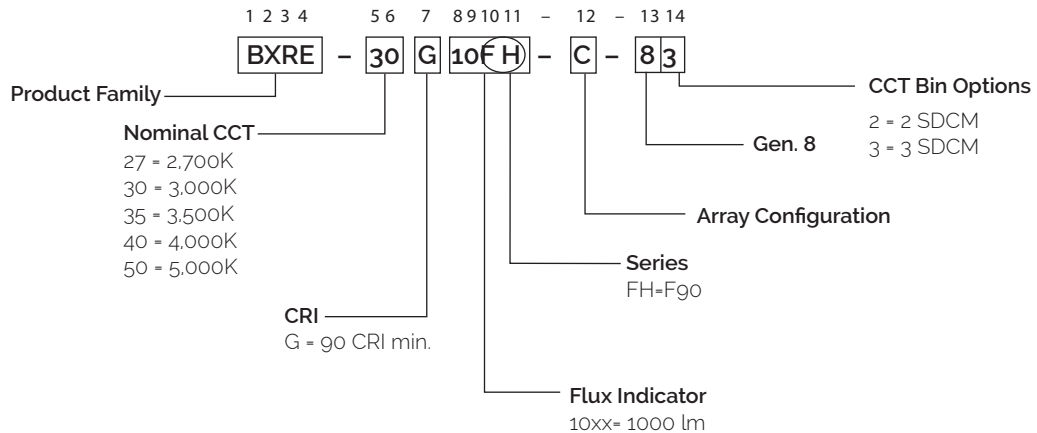

Product Selection Guide

The following product configurations are available:

Table 1: Selection Guide, Pulsed Measurement Data ($T_j = T_c = 25^\circ\text{C}$)

Part Number	Nominal CCT ¹ (K)	CRI ²	Nominal Drive Current ³ (mA)	Typical Pulsed Flux ^{4,5,6} $T_c = 25^\circ\text{C}$ (lm)	Minimum Pulsed Flux ^{6,7} $T_c = 25^\circ\text{C}$ (lm)	Typical V_f (V)	Typical Power (W)	Typical Efficacy (lm/W)
BXRE-27G10FH-A-8x	2700	90	300	1770	1593	34.5	10.3	171
BXRE-27G10FH-B-8x	2700	90	200	1176	1058	34.1	6.8	172
BXRE-27G10FH-C-8x	2700	90	300	1623	1460	31.6	9.5	171
BXRE-30G10FH-A-8x	3000	90	300	1806	1626	34.5	10.3	175
BXRE-30G10FH-B-8x	3000	90	200	1200	1080	34.1	6.8	176
BXRE-30G10FH-C-8x	3000	90	300	1656	1490	31.6	9.5	175
BXRE-35G10FH-A-8x	3500	90	300	1796	1616	34.5	10.3	174
BXRE-35G10FH-B-8x	3500	90	200	1193	1073	34.1	6.8	175
BXRE-35G10FH-C-8x	3500	90	300	1646	1482	31.6	9.5	174
BXRE-40G10FH-A-8x	4000	90	300	1814	1632	34.5	10.3	175
BXRE-40G10FH-B-8x	4000	90	200	1204	1084	34.1	6.8	176
BXRE-40G10FH-C-8x	4000	90	300	1663	1496	31.6	9.5	175

Notes for Table 1:

- Nominal CCT as defined by ANSI C78.377-2011.
- CRI values are minimums and tested at $T_j = T_c = 25^\circ\text{C}$. Minimum Rg value for 90 CRI products is 50. Bridgelux maintains a ± 3 tolerance on CRI and Rg values.
- Drive current is referred to as nominal drive current.
- Products tested under pulsed condition (10ms pulse width) at nominal test current where T_j (junction temperature) = T_c (case temperature) = 25°C .
- Typical performance values are provided as a reference only and are not a guarantee of performance.
- Bridgelux maintains a $\pm 7\%$ tolerance on flux measurements.
- Minimum flux values at the nominal test current are guaranteed by 100% test.

Product Selection Guide

Table 2: Selection Guide, Stabilized DC Performance ($T_c = 65^\circ\text{C}$)^{4,5}

Part Number	Nominal CCT ¹ (K)	CRI ²	Nominal Drive Current ³ (mA)	Typical DC Flux ^{4,5} $T_c = 65^\circ\text{C}$ (lm)	Minimum DC Flux ⁶ $T_c = 65^\circ\text{C}$ (lm)	Typical V_f (V)	Typical Power (W)	Typical Efficacy (lm/W)
BXRE-27G10FH-A-8x	2700	90	300	1655	1490	34.0	10.2	162
BXRE-27G10FH-B-8x	2700	90	200	1099	989	33.7	6.7	163
BXRE-27G10FH-C-8x	2700	90	300	1517	1366	31.2	9.4	162
BXRE-30G10FH-A-8x	3000	90	300	1689	1520	34.0	10.2	165
BXRE-30G10FH-B-8x	3000	90	200	1122	1009	33.7	6.7	166
BXRE-30G10FH-C-8x	3000	90	300	1548	1393	31.2	9.4	165
BXRE-35G10FH-A-8x	3500	90	300	1679	1511	34.0	10.2	165
BXRE-35G10FH-B-8x	3500	90	200	1115	1004	33.7	6.7	165
BXRE-35G10FH-C-8x	3500	90	300	1539	1385	31.2	9.4	165
BXRE-40G10FH-A-8x	4000	90	300	1696	1526	34.0	10.2	166
BXRE-40G10FH-B-8x	4000	90	200	1126	1014	33.7	6.7	167
BXRE-40G10FH-C-8x	4000	90	300	1555	1399	31.2	9.4	166

Notes for Table 2:

- Nominal CCT as defined by ANSI C78.377-2011.
- CRI values are minimums and tested at $T_j = T_c = 65^\circ\text{C}$. Minimum R_g value for 90 CRI products is 50.
- Drive current is referred to as nominal drive current.
- Typical stabilized DC performance values are provided as reference only and are not a guarantee of performance.
- Typical performance is estimated based on operation under DC (direct current) with LED array mounted onto a heat sink with thermal interface material and the case temperature maintained at 65°C . Based on Bridgelux test setup, values may vary depending on the thermal design of the luminaire and/or the exposed environment to which the product is subjected.
- Minimum flux values at elevated temperatures are provided for reference only and are not guaranteed by 100% production testing. Based on Bridgelux test setup, values may vary depending on the thermal design of the luminaire and/or the exposed environment to which the product is subjected.

European Product Registry for Energy Labeling

The European Product Registry for Energy Labeling (EPREL) is defined in the EU Regulation 2017/1369 to provide important energy efficiency information to consumers. Together with Energy Labeling Regulation ELR (EU) 2019/2015 which was amended by regulation (EU) 2021/340 for energy labelling of light sources, manufacturers are required to declare an energy class based on key technical specifications from each of their product and register it in an open data base managed by EPREL. It is now a legal requirement for a vendor of light sources to upload information about their products into the EPREL database before placing these products on the market in the EU.

Table 3 below provides a list of part numbers that are in compliance with ELR and are currently listed in the EPREL database.

At Bridgelux, we are fully committed to supplying products that are compliant with pertinent laws, rules, and obligation imposed by relevant government bodies including the European Energy Labeling regulation. Customers can use these products with full confidence for any projects that fall under the ELR.

Table 3: Part numbers registered in European Product Registry for Energy Labeling

PART NUMBER ¹	CCT (K)	CRI	Current ² (mA)	Vf (V)	Useful flux ³ (Φ_{use}) at 85C (lm)	Power (W)	Efficacy (lm/W)	Energy efficiency class ⁴	Registration No	URL to Product Information Sheet in EPREL Database
BXRE-27G10FH-A-83	2700	90	720	38.0	3460	27	126	E	1441951	https://eprelec.europa.eu/qr/1441951
BXRE-27G10FH-B-83	2700	90	540	38.0	2549	21	124	E	1441952	https://eprelec.europa.eu/qr/1441952
BXRE-27G10FH-C-83	2700	90	720	34.8	3155	25	126	E	1441953	https://eprelec.europa.eu/qr/1441953
BXRE-30G10FH-A-83	3000	90	720	38.0	3530	27	129	E	1441968	https://eprelec.europa.eu/qr/1441968
BXRE-30G10FH-B-83	3000	90	540	38.0	2601	21	127	E	1441969	https://eprelec.europa.eu/qr/1441969
BXRE-30G10FH-C-83	3000	90	720	34.8	3220	25	128	E	1441970	https://eprelec.europa.eu/qr/1441970
BXRE-35G10FH-A-83	3500	90	720	38.0	3511	27	128	E	1441985	https://eprelec.europa.eu/qr/1441985
BXRE-35G10FH-B-83	3500	90	540	38.0	2600	21	127	E	1441986	https://eprelec.europa.eu/qr/1441986
BXRE-35G10FH-C-83	3500	90	720	34.8	3219	25	128	E	1441987	https://eprelec.europa.eu/qr/1441987
BXRE-40G10FH-A-83	4000	90	720	38.0	3546	27	130	E	1442002	https://eprelec.europa.eu/qr/1442002
BXRE-40G10FH-B-83	4000	90	540	38.0	2626	21	128	E	1442003	https://eprelec.europa.eu/qr/1442003
BXRE-40G10FH-C-83	4000	90	720	34.8	3250	25	130	E	1442004	https://eprelec.europa.eu/qr/1442004

Notes for Table 3:

1. All device listed here must be disposed as e-waste upon its end of life according to local country guideline in each country.
2. For information on performance values at alternative drive conditions, please refer to the Product Selection Guide, Absolute Maximum Rating Table and Performance Curves in this data sheet.
3. For a definition of useful luminous flux (Φ_{use}), please see the ELR regulations at <https://tinyurl.com/4b6zvt4m>.
4. EPREL requires an arrow symbol containing the letter of the energy efficiency class to be displayed, on technical promotional material. Refer to this energy efficiency class column for specific energy efficiency class on each part number.

Performance at Commonly Used Drive Currents

V Series LED arrays are tested to the specifications shown using the nominal drive currents in Table 1. V Series LED Arrays may also be driven at other drive currents dependent on specific application design requirements. The performance at any drive current can be derived from the current vs. voltage characteristics shown in Figures 1, 2 & 3 and the flux vs. current characteristics shown in Figures 4, 5 & 6. The performance at commonly used drive currents is summarized in Table 4.

Table 4: Product Performance at Commonly Used Drive Currents

Part Number	CRI	Drive Current ¹ (mA)	Typical V _f T _c = 25°C (V)	Typical Power T _c = 25°C (W)	Typical Flux ² T _c = 25°C (lm)	Typical DC Flux ³ T _c = 65°C (lm)	Typical Efficacy T _c = 25°C (lm/W)
BXRE-27G10FH-A-8x	90	150	33.1	5.0	907	860	182
		225	33.8	7.6	1347	1266	177
		300	34.5	10.3	1770	1655	171
		360	35.0	12.6	2113	1947	168
		600	36.9	22.1	3389	3064	153
		720	37.7	27.2	3986	3542	147
BXRE-27G10FH-B-8x	90	100	32.9	3.3	598	569	182
		150	33.6	5.0	890	839	177
		200	34.1	6.8	1176	1099	172
		270	34.9	9.4	1565	1446	166
		400	36.3	14.5	2256	2044	155
		540	37.7	20.3	2952	2631	145
BXRE-27G10FH-C-8x	90	150	30.4	4.6	828	788	182
		225	31.0	7.0	1230	1160	176
		300	31.6	9.5	1623	1517	171
		360	32.1	11.5	1930	1784	167
		600	33.8	20.3	3095	2809	153
		720	34.6	24.9	3640	3247	146
BXRE-30G10FH-A-8x	90	150	33.1	5.0	925	878	186
		225	33.8	7.6	1375	1291	181
		300	34.5	10.3	1806	1689	175
		360	35.0	12.6	2156	1986	171
		600	36.9	22.1	3458	3126	156
		720	37.7	27.2	4067	3615	150
BXRE-30G10FH-B-8x	90	100	32.9	3.3	610	581	185
		150	33.6	5.0	908	857	180
		200	34.1	6.8	1200	1122	176
		270	34.9	9.4	1597	1476	169
		400	36.3	14.5	2302	2086	158
		540	37.7	20.3	3013	2684	148
BXRE-30G10FH-C-8x	90	150	30.4	4.6	845	805	186
		225	31.0	7.0	1255	1184	180
		300	31.6	9.5	1656	1548	175
		360	32.1	11.5	1969	1821	171
		600	33.8	20.3	3158	2866	156
		720	34.6	24.9	3715	3313	149

Notes for Table 4:

1. Alternate drive currents in Table 4 are provided for reference only and are not a guarantee of performance.
2. Bridgelux maintains a ± 7% tolerance on flux measurements.
3. Typical stabilized DC performance values are provided as reference only and are not a guarantee of performance.

Performance at Commonly Used Drive Currents

Table 4: Product Performance at Commonly Used Drive Currents (Continued)

Part Number	CRI	Drive Current ¹ (mA)	Typical V_f $T_c = 25^\circ\text{C}$ (V)	Typical Power $T_c = 25^\circ\text{C}$ (W)	Typical Flux ² $T_c = 25^\circ\text{C}$ (lm)	Typical DC Flux ³ $T_c = 65^\circ\text{C}$ (lm)	Typical Efficacy $T_c = 25^\circ\text{C}$ (lm/W)
BXRE-35G10FH-A-8x	90	150	33.1	5.0	920	873	185
		225	33.8	7.6	1367	1284	180
		300	34.5	10.3	1796	1679	174
		360	35.0	12.6	2143	1975	170
		600	36.9	22.1	3438	3109	155
		720	37.7	27.2	4044	3594	149
BXRE-35G10FH-B-8x	90	100	32.9	3.3	607	578	184
		150	33.6	5.0	903	852	179
		200	34.1	6.8	1193	1115	175
		270	34.9	9.4	1588	1467	168
		400	36.3	14.5	2288	2074	157
		540	37.7	20.3	2995	2669	147
BXRE-35G10FH-C-8x	90	150	30.4	4.6	840	800	184
		225	31.0	7.0	1248	1177	179
		300	31.6	9.5	1646	1539	174
		360	32.1	11.5	1958	1810	170
		600	33.8	20.3	3140	2850	155
		720	34.6	24.9	3694	3295	148
BXRE-40G10FH-A-8x	90	150	33.1	5.0	929	881	187
		225	33.8	7.6	1380	1297	181
		300	34.5	10.3	1814	1696	175
		360	35.0	12.6	2165	1995	172
		600	36.9	22.1	3472	3139	157
		720	37.7	27.2	4084	3630	150
BXRE-40G10FH-B-8x	90	100	32.9	3.3	613	583	186
		150	33.6	5.0	912	860	181
		200	34.1	6.8	1204	1126	176
		270	34.9	9.4	1603	1482	170
		400	36.3	14.5	2311	2095	159
		540	37.7	20.3	3025	2695	149
BXRE-40G10FH-C-8x	90	150	30.4	4.6	849	808	186
		225	31.0	7.0	1261	1189	181
		300	31.6	9.5	1663	1555	175
		360	32.1	11.5	1977	1828	171
		600	33.8	20.3	3171	2878	156
		720	34.6	24.9	3730	3327	150

Notes for Table 4:

1. Alternate drive currents in Table 4 are provided for reference only and are not a guarantee of performance.
2. Bridgelux maintains a $\pm 7\%$ tolerance on flux measurements.
3. Typical stabilized DC performance values are provided as reference only and are not a guarantee of performance.

Electrical Characteristics

Table 5: Electrical Characteristics

Part Number	Drive Current (mA)	Forward Voltage Pulsed, $T_c = 25^\circ\text{C}$ (V) ^{1, 2, 3, 8}			Typical Coefficient of Forward Voltage ⁴ $\Delta V_f / \Delta T_c$ (mV/ $^\circ\text{C}$)	Typical Thermal Resistance Junction to Case ^{5,6} R_{j-c} ($^\circ\text{C}/\text{W}$)	Driver Selection Voltages ⁷ (V)	
		Minimum	Typical	Maximum			V_f Min. Hot $T_c = 95^\circ\text{C}$ (V)	V_f Max. Cold $T_c = -40^\circ\text{C}$ (V)
BXRE-xxx10Fx-A-8x	300	32.4	34.5	36.5	-9.64	0.41	31.7	37.2
	720	35.5	37.7	40.0	-10.55	0.60	34.7	40.7
BXRE-xxx10Fx-B-8x	200	32.1	34.1	36.2	-9.55	0.62	31.4	36.8
	540	35.4	37.7	39.9	-10.54	0.95	34.7	40.6
BXRE-xxx10Fx-C-8x	300	29.7	31.6	33.5	-8.84	0.38	29.1	34.1
	720	32.5	34.6	36.7	-9.67	0.55	31.8	37.3

Notes for Table 5:

- Parts are tested in pulsed conditions. $T_c = 25^\circ\text{C}$. Pulse width is 10ms.
- Voltage minimum and maximum are provided for reference only and are not a guarantee of performance.
- Bridgelux maintains a tester tolerance of $\pm 0.10\text{V}$ on forward voltage measurements.
- Typical coefficient of forward voltage tolerance is $\pm 0.1\text{mV}$ for nominal current.
- Thermal resistance values are based from test data of a 3000K 90 CRI product.
- Thermal resistance value was calculated using total electrical input power; optical power was not subtracted from input power. The thermal interface material used during testing is not included in the thermal resistance value.
- V_f min hot and max cold values are provided as reference only and are not guaranteed by test. These values are provided to aid in driver design and selection over the operating range of the product.
- This product has been designed and manufactured per IEC 62031:2018. This product has passed dielectric withstand voltage testing at 1140 V. The working voltage designated for the insulation is 70V d.c. The maximum allowable voltage across the array must be determined in the end product application.

Eye Safety

Table 6: Eye Safety Risk Group (RG) Classifications

Part Number	Drive Current (mA)	CCT ⁴	
		2700K/3000K	3500-5000K ^{2,3}
BXRE-xxx10Fx-A-8x	415	RG1	RG1
	720	RG1	RG2
BXRE-xxx10Fx-B-8x	405	RG1	RG1
	540	RG1	RG2
BXRE-xxx10Fx-C-8x	450	RG1	RG1
	720	RG1	RG2

Notes for Table 6:

1. Eye safety classification for the use of Bridgelux V Series LED arrays is in accordance with specification IEC/TR 62778: Application of IEC 62471 for the assessment of blue light hazard to light sources and luminaires.
2. For products classified as RG2 at 4000K, Ethr= 1980 lx.
3. For products classified as RG2 at 5000K Ethr= 1530 lx.
4. Please contact your Bridgelux sales representative for Ethr values at specific drive currents and CCTs not listed.

Absolute Maximum Ratings

Table 7: Maximum Ratings

Parameter	Maximum Rating		
LED Junction Temperature (T _J)	150°C		
Storage Temperature ¹	-40°C to +95°C		
Operating Case Temperature ² (T _C)	95°C		
Soldering Temperature ³	300°C or lower for a maximum of 6 seconds		
	BXRE-xxG10Fx-A-8x	BXRE-xxG10Fx-B-8x	BXRE-xxG10Fx-C-8x
Maximum Drive Current ⁴	720 mA at ≤85°C 540 mA at 95°C	540 mA at ≤85°C 405 mA at 95°C	720 mA at ≤85°C 540 mA at 95°C
Maximum Peak Pulsed Drive Current ⁵	1030mA	770mA	1030mA
Maximum Reverse Voltage ⁶	-60V	-60V	-55V

Notes for Table 7:

1. The F90 product is robust enough to pass our internal humidity test but it is still more sensitive compared to regular LED array product. The product needs to be stored in a dry environment. It is not recommended to use the product in a damp environment that directly exposes it to moisture.
2. For IEC 62717 requirement, please consult your Bridgelux sales representative.
3. Refer to Bridgelux Application Note AN101: Handling and Assembly of Bridgelux V Series LED Arrays
4. Arrays may be driven at higher currents however lumen maintenance may be reduced and warranty will not apply.
5. Bridgelux recommends a maximum duty cycle of 10% and pulse width of 20 ms when operating LED Arrays at maximum peak pulsed current specified. Maximum peak pulsed currents indicate values where LED Arrays can be driven without catastrophic failures.
6. Light emitting diodes are not designed to be driven in reverse voltage and will not produce light under this condition. Maximum rating provided for reference only.

Performance Curves

Figure 1: V10A Drive Current vs. Voltage

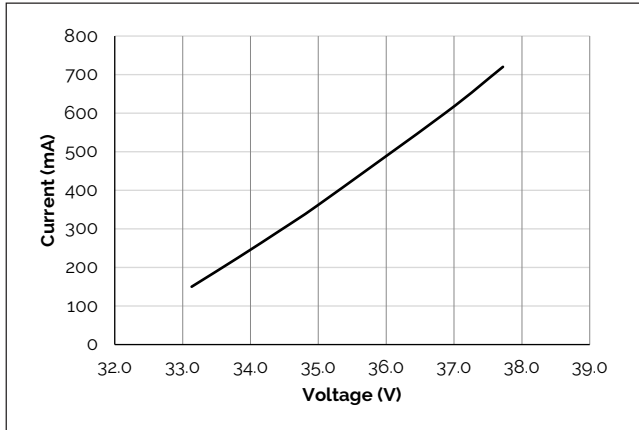

Figure 2: V10B Drive Current vs. Voltage

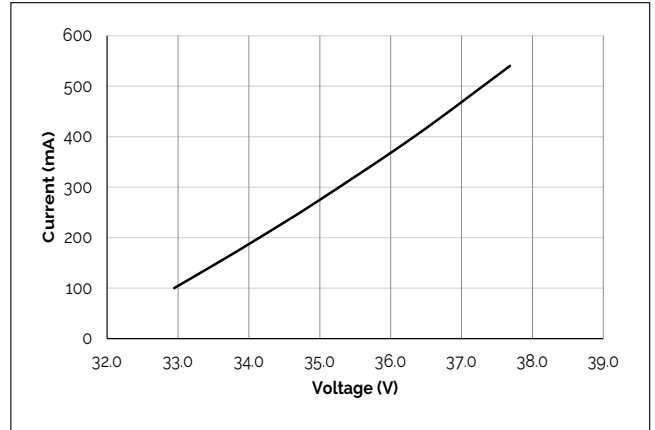

Figure 3: V10C Drive Current vs. Voltage

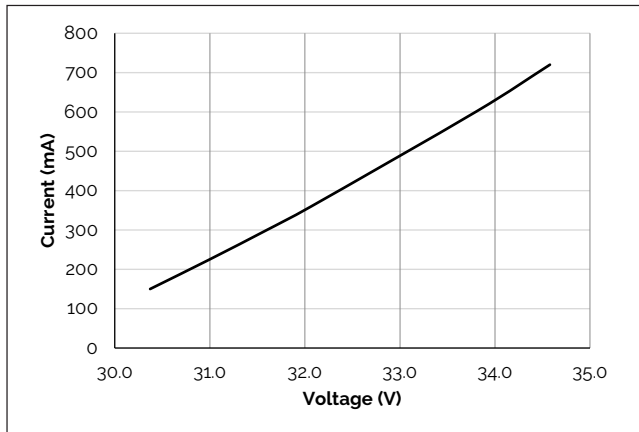

Figure 4: V10A Typical Relative Flux vs. Current

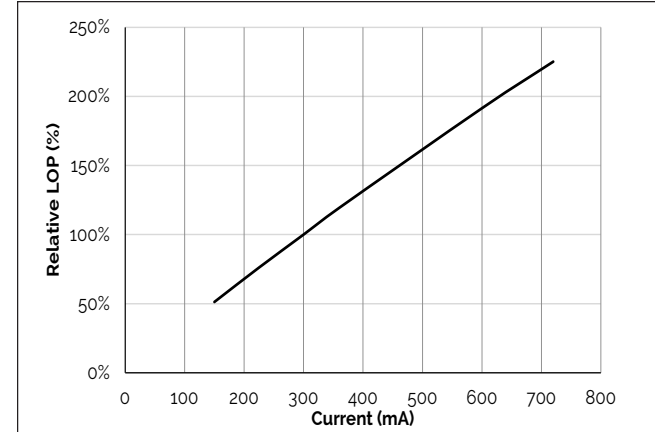

Figure 5: V10B Typical Relative Flux vs. Current

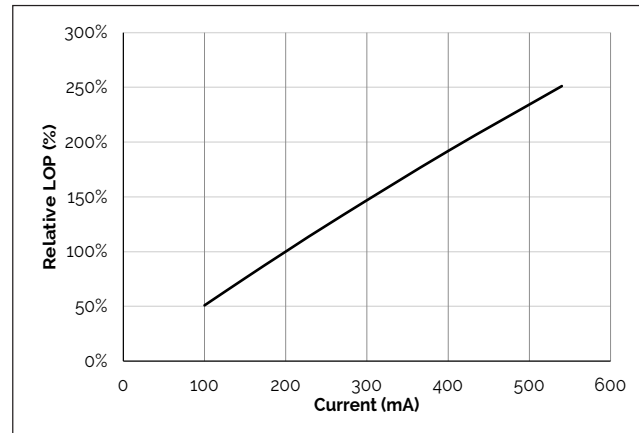
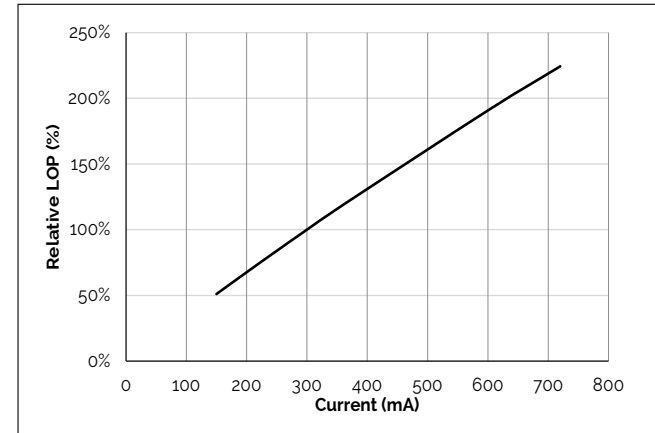

Figure 6: V10C Typical Relative Flux vs. Current



Notes for Figures 1-6:

1. Bridgelux does not recommend driving high power LEDs at low currents. Doing so may produce unpredictable results. Pulse width modulation (PWM) is recommended for dimming effects.
2. Products tested under pulsed condition (10ms pulse width) at nominal test current where T_j (junction temperature) = T_c (case temperature) = 25°C.

Performance Curves

Figure 7: Typical DC Flux vs. Case Temperature

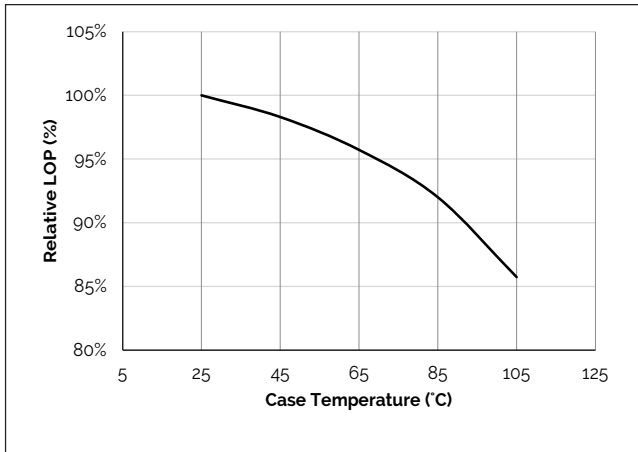

Figure 8: Typical DC ccx Shift vs. Case Temperature

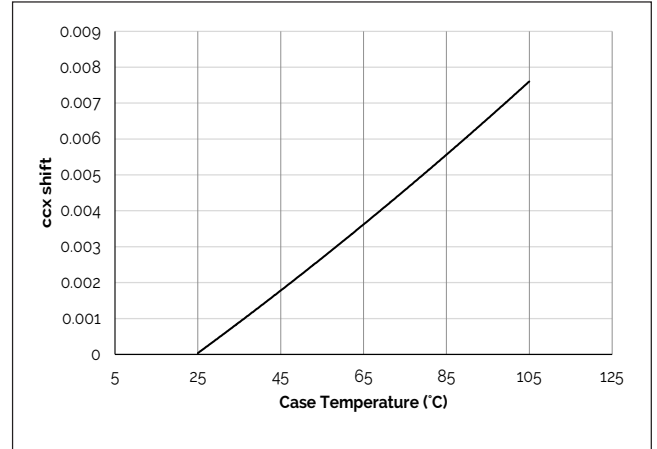

Figure 9: Typical DC ccy Shift vs. Case Temperature

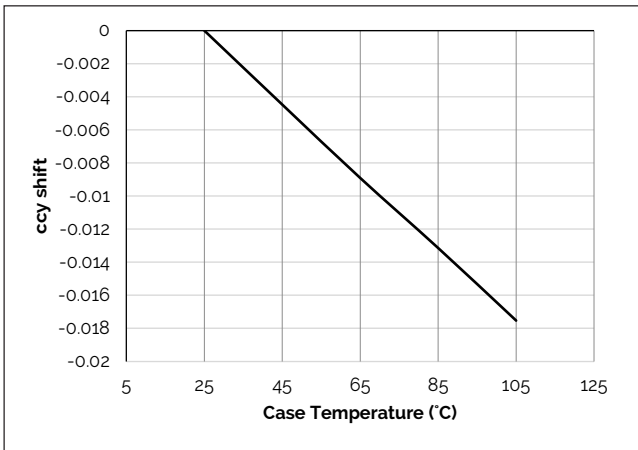
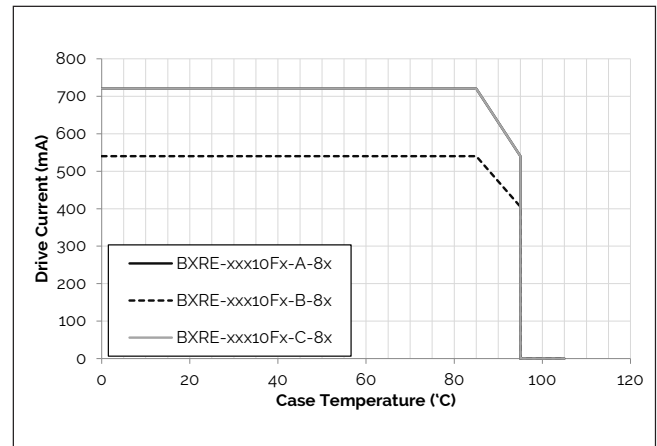

Figure 10: Derating Curve



Note for Figures 7-9:

1. Characteristics shown for Warm White.

Typical Radiation Pattern

Figure 11: Typical Spatial Radiation Pattern

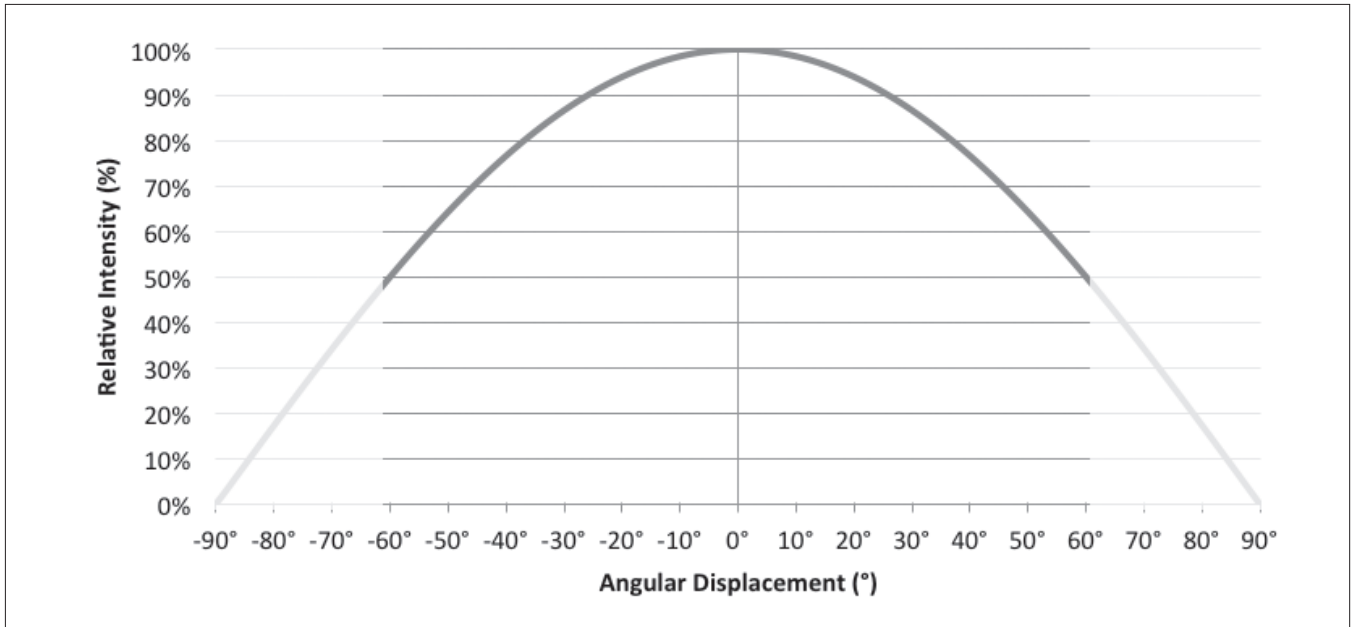

Notes for Figure 11:

1. Typical viewing angle is 120°.
2. The viewing angle is defined as the off axis angle from the centerline where intensity is ½ of the peak value.

Figure 12: Typical Polar Radiation Pattern

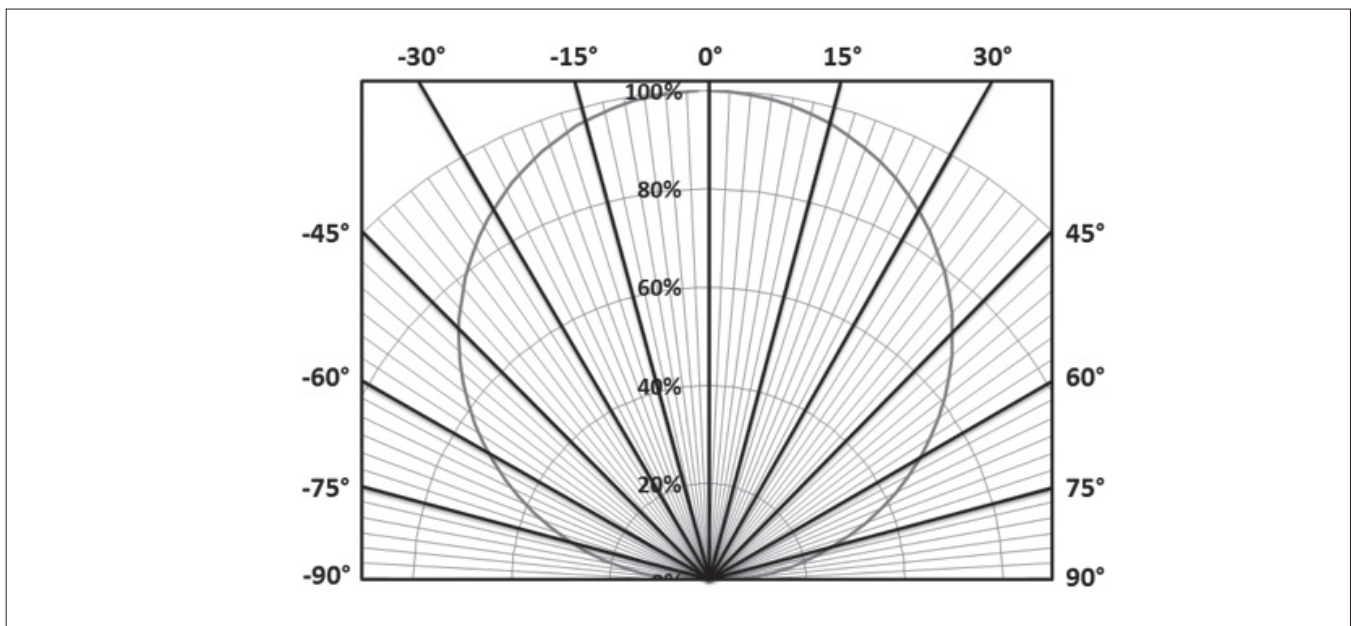

Typical Color Spectrum

Figure 13: Typical Color Spectrum

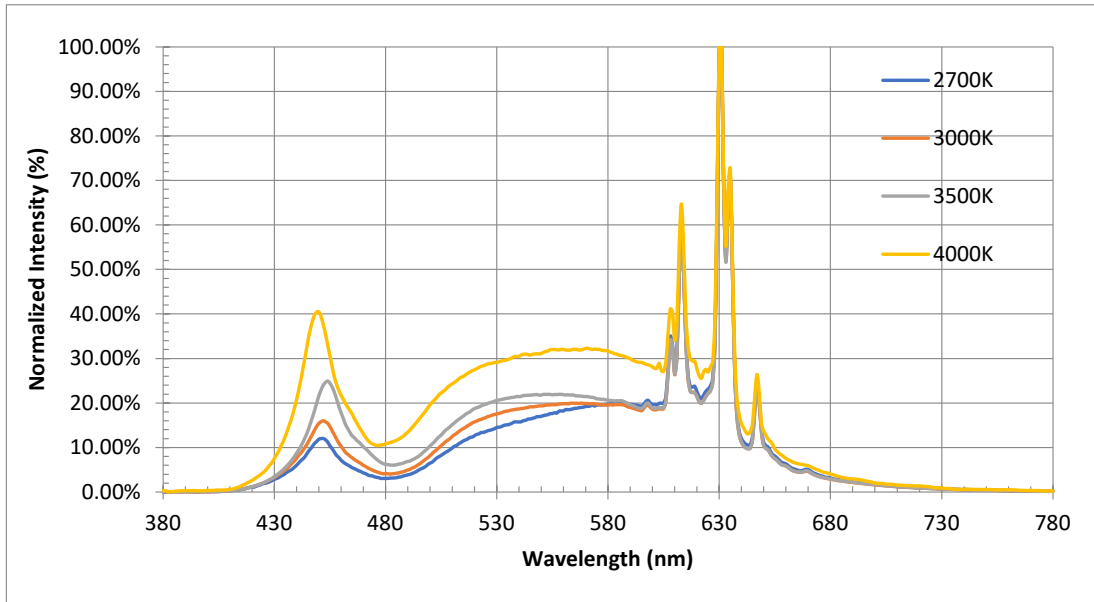

Notes for Figure 13:

1. Color spectra measured at nominal current for $T_j = T_c = 65^\circ\text{C}$.
2. Color spectra shown is 2700K and 90CRI.
3. Color spectra shown is 3000K and 90 CRI.
4. Color spectra shown is 3500K and 90 CRI.
5. Color spectra shown is 4000K and 90 CRI.

Mechanical Dimensions

Figure 14 Drawing for V10 LED Array

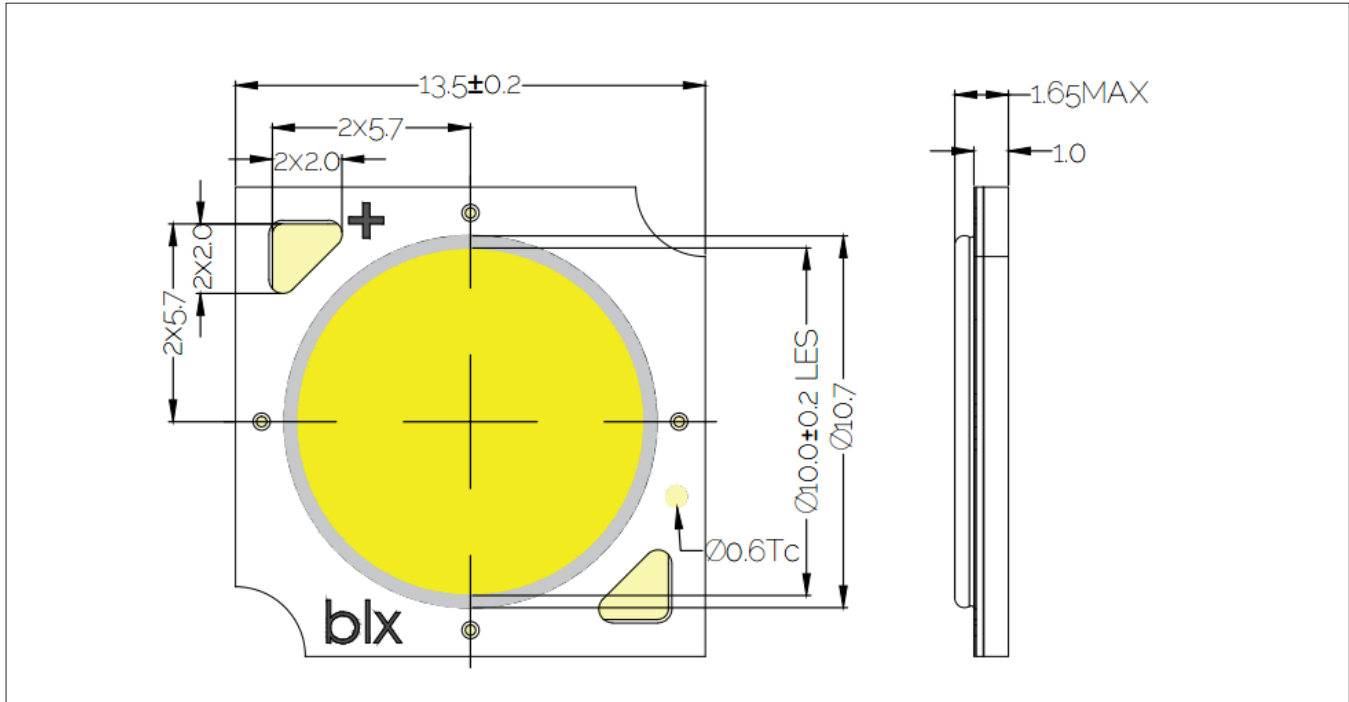

Notes for Figure 14:

1. Drawings are not to scale.
2. Drawing dimensions are in millimeters.
3. Unless otherwise specified, tolerances are ± 0.1 mm.
4. Solder pad labeled "+" denotes positive contact.
5. Refer to Application Notes AN101 for product handling, mounting and heat sink recommendations.
6. The optical center of the LED Array is nominally defined by the mechanical center of the array to a tolerance of ± 0.2 mm.
7. Bridgelux maintains a flatness of 0.10 mm across the mounting surface of the array.

Color Binning Information

Figure 15: Warm and Neutral White Test Bins in xy Color Space

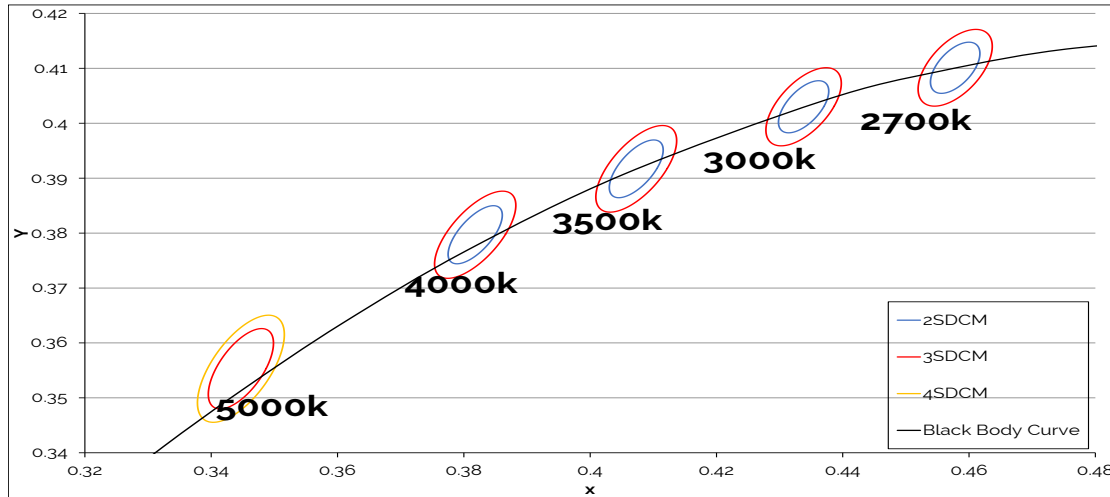

Note: Pulsed Test Conditions, $T_c = 65^\circ\text{C}$

Table 8: Warm and Neutral White xy Bin Coordinates and Associated Typical CCT (product is hot targeted to $T_c = 65^\circ\text{C}$)

Bin Code	2700K	3000K	3500K	4000K
ANSI Bin (for reference only)	(2580K - 2870K)	(2870K - 3220K)	(3220K - 3710K)	(3710K - 4260K)
83 (3 SDCM)	(2651K - 2794K)	(2968K - 3136K)	(3369K - 3586K)	(3851K - 4130K)
82 (2 SDCM)	(2674K - 2769K)	(2995K - 3107K)	(3404K - 3548K)	(3895K - 4081K)
Center Point (x,y)	(0.4578, 0.4101)	(0.4338, 0.403)	(0.4073, 0.3917)	(0.3818, 0.3797)

Note for Tables 8:

1. Bridgelux maintains a tolerance of +/- 0.007 on x and y color coordinates in the CIE 1931 color Space.

Packaging and Labeling

Figure 16: V10 Packaging Tube

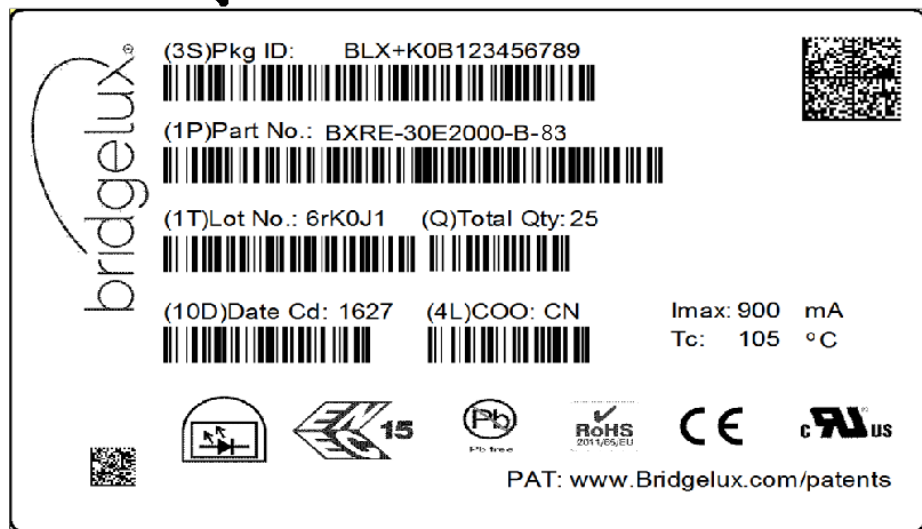

Box Label

Commercial Invoice
and Packing list



Notes for Figure 16:

1. Each tube holds 30 V10 COB arrays.
2. One tube is sealed in an anti-static bag. Four bags are placed in a shipping box. Depending on quantities ordered, a bigger shipping box, containing four boxes may be used to ship products.
3. Each bag and box is to be labeled as shown above.
4. Dimensions for each tube are 8.3 (W) x 15.4 (H) x 430 (L). Dimensions for the anti-static bag are 75 (W) x 615 (L) x 3.1 (T) mm. Dimensions for the shipping box are 58.7 x 13.3 x 7.9 cm

Packaging and Labeling

Figure 17: Gen. 8 Product Labeling

Bridgelux COB arrays have laser markings on the back side of the substrate to help with product identification. In addition to the product identification markings, Bridgelux COB arrays also contain markings for internal Bridgelux manufacturing use only. The image below shows which markings are for customer use and which ones are for Bridgelux internal use only. The Bridgelux internal manufacturing markings are subject to change without notice, however these will not impact the form, function or performance of the COB array.

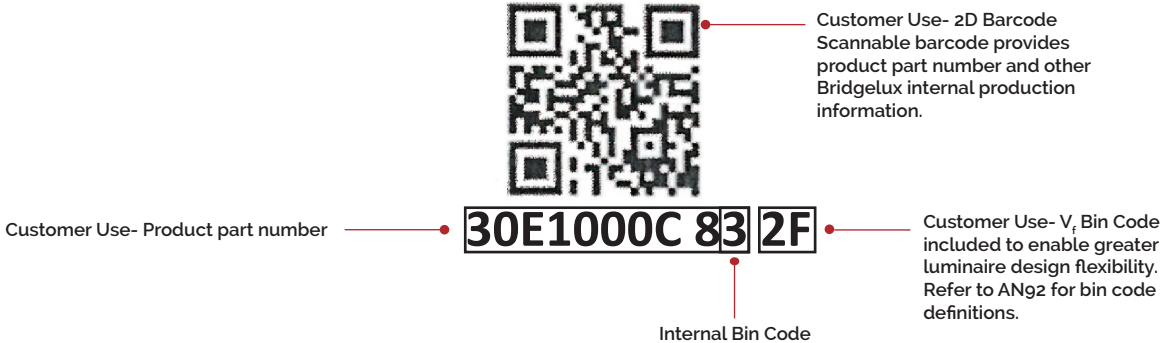

Design Resources

Application Notes

Bridgelux has developed a comprehensive set of application notes and design resources to assist customers in successfully designing with the V Series product family of LED array products. For all available application notes visit www.bridgelux.com.

Optical Source Models

Optical source models and ray set files are available for all Bridgelux products. For a list of available formats, visit www.bridgelux.com.

3D CAD Models

Three dimensional CAD models depicting the product outline of all Bridgelux V Series LED arrays are available in both IGS and STEP formats. Please contact your Bridgelux sales representative for assistance.

LM80

Please contact your Bridgelux sales representative for LM-80 report.

Precautions

CAUTION: CHEMICAL EXPOSURE HAZARD

Exposure to some chemicals commonly used in luminaire manufacturing and assembly can cause damage to the LED array. Please consult Bridgelux Application Note AN101 for additional information.

CAUTION: RISK OF BURN

Do not touch the V Series LED array during operation. Allow the array to cool for a sufficient period of time before handling. The V Series LED array may reach elevated temperatures such that could burn skin when touched.

CAUTION

CONTACT WITH LIGHT EMITTING SURFACE (LES)

Avoid any contact with the LES. Do not touch the LES of the LED array or apply stress to the LES (yellow phosphor resin area). Contact may cause damage to the LED array.

Optics and reflectors must not be mounted in contact with the LES (yellow phosphor resin area).

Disclaimers

MINOR PRODUCT CHANGE POLICY

The rigorous qualification testing on products offered by Bridgelux provides performance assurance. Slight cosmetic changes that do not affect form, fit, or function may occur as Bridgelux continues product optimization.

STANDARD TEST CONDITIONS

Unless otherwise stated, array testing is performed at the nominal drive current.

About Bridgelux: Bridging Light and Life™

At Bridgelux, we help companies, industries and people experience the power and possibility of light. Since 2002, we've designed LED solutions that are high performing, energy efficient, cost effective and easy to integrate. Our focus is on light's impact on human behavior, delivering products that create better environments, experiences and returns—both experiential and financial. And our patented technology drives new platforms for commercial and industrial luminaires.

For more information about the company, please visit
bridgelux.com
twitter.com/Bridgelux
facebook.com/Bridgelux
youtube.com/user/Bridgelux
linkedin.com/company/bridgelux-inc-_2
WeChat ID: BridgeluxInChina



46410 Fremont Boulevard
Fremont, CA 94538 U.S.A.
Tel (925) 583-8400
www.bridgelux.com

© 2022 Bridgelux, Inc. All rights reserved. Product specifications are subject to change without notice. Bridgelux, the Bridgelux stylized logo design, Vero, V Series and V Series HD are registered trademarks, and Decor Series is a trademark of Bridgelux, Inc. All other trademarks are the property of their respective owners.

Bridgelux V10 Fgo Array Series Product Data Sheet DS446-3 Rev. A (02/2023)