



# Bridgelux Vero® SE 13 F90 Array

Product Data Sheet DS358



# Introduction

Vero SE F90



The Vero® SE Series is a revolutionary light source system that integrates Bridgelux's eighth generation COB technology with poke-in connectivity, enabling solder-free installation. Vero SE LED light sources streamline assembly processes, lower manufacturing costs, simplify the luminaire design process, improve light quality, and increase design flexibility.

Vero SE is available in four different light emitting surface (LES) configurations that operate reliably over a broad current range. With Vero SE, secondary connector and holder components are not required, allowing for rapid integration of arrays into fixtures, and an efficient field replaceable solution. Vero SE arrays deliver increased lumen density for improved beam control and precision lighting, with 2 and 3 SDCM color control standards for clean and consistent uniform lighting.

The F90 Vero® SE Series COB is a high efficacy product that uses narrow band red phosphor to significantly improve the spectrum efficacy. The improved spectrum efficacy results in the 90 CRI product of the F90 Series delivering better or equivalent efficacy as that of our traditional 80 CRI Vero® SE Series product.

## Features

- Efficacy of 184 lm/W typical, 3000K 90 CRI
- Wide selection of CCT options (2700K-5000K) with minimum 90 CRI options
- Uniform high-quality illumination
- 2 and 3 SDCM binning options (2700K - 4000K)
- 3 and 4 SDCM binning options (5000K)
- Forward voltage bin codes and backside marking
- Instant light with unlimited dimming
- Thermally isolated solder pads

## Benefits

- Solder free installation and field upgradability
- Improved inventory management and quality control
- Enables high efficiency lighting systems and lower operating costs
- Supports the trend toward luminaire miniaturization and delivers enhanced optical control
- Design flexibility for a broad range of lighting applications
- Clean white light without pixelation
- Uniform consistent white light
- Design flexibility for multi-source applications
- Enhanced ease of use and installation



# Contents

Product Feature Map	2
Product Nomenclature	2
Product Selection Guide	3
European Product Registry for Energy Labeling	4
Performance at Commonly Used Drive Currents	5
Electrical Characteristics	7
Eye Safety	8
Absolute Maximum Ratings	9
Performance Curves	10
Typical Radiation Pattern	12
Typical Color Spectrum	13
Product Bin Definitions	14
Mechanical Dimensions	15
Packaging and Labeling	16
Design Resources	18
Precautions	18
Disclaimers	18
About Bridgelux	19

# Product Feature Map

Vero SE 13 is the second smallest form factor in the product family of the next generation solid state light sources. In addition to delivering the performance and light quality required for many lighting applications,

Vero SE incorporates several features to simplify the design integration and manufacturing process, accelerate time to market and reduce system costs. Please visit [www.bridgelux.com](http://www.bridgelux.com) for more information on the Vero SE family of products.

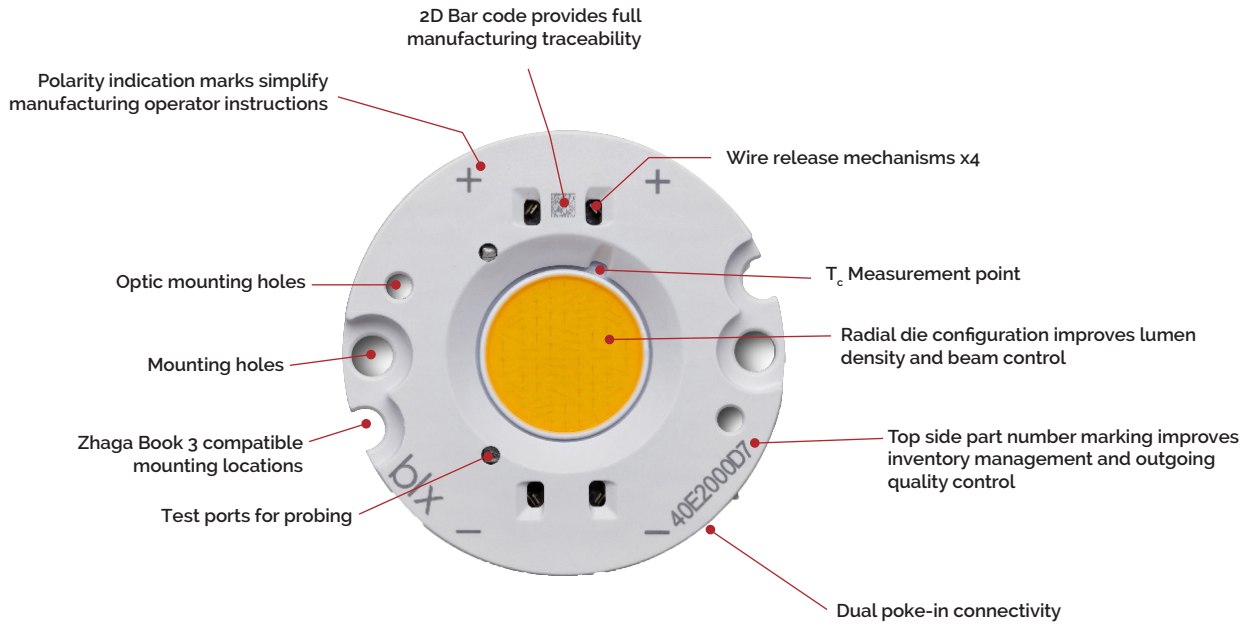

## Product Nomenclature

The part number designation for Bridgelux COB arrays is explained as follows:

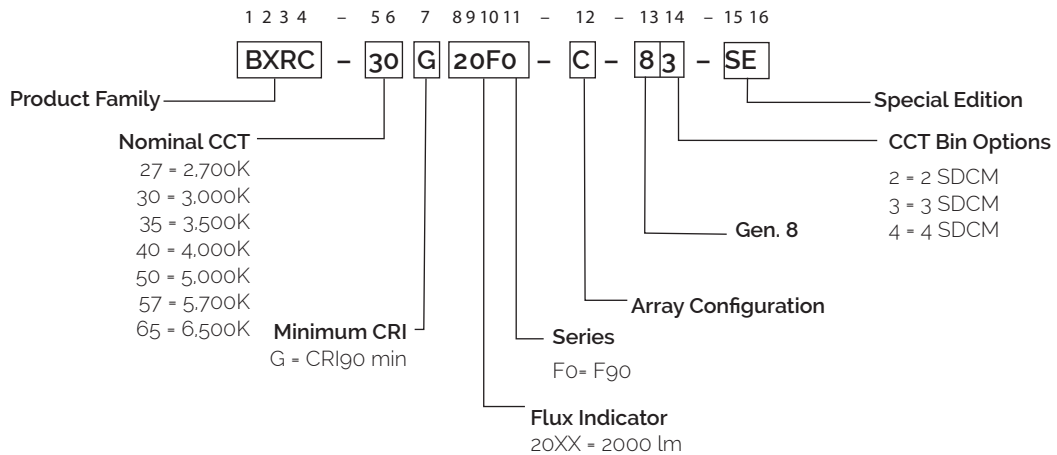

# Product Selection Guide

The following product configurations are available:

**Table 1:** Selection Guide, Pulsed Measurement Data ( $T_c = 25^\circ\text{C}$ )

Part Number	Nominal CCT <sup>1</sup> (K)	CRI <sup>2</sup>	Nominal Drive Current <sup>3</sup> (mA)	Typical Pulsed Flux <sup>4,5,6</sup> $T_c = 25^\circ\text{C}$ (lm)	Minimum Pulsed Flux <sup>6,7</sup> $T_c = 25^\circ\text{C}$ (lm)	Typical $V_f$ (V)	Typical Power (W)	Typical Efficacy (lm/W)
BXRC-27G20F0-B-8x-SE	2700	90	350	2167	1950	34.3	12	181
BXRC-27G20F0-C-8x-SE	2700	90	500	3083	2775	34.3	17.1	180
BXRC-30G20F0-B-8x-SE	3000	90	350	2211	1990	34.3	12	184
BXRC-30G20F0-C-8x-SE	3000	90	500	3146	2831	34.3	17.1	184
BXRC-35G20F0-B-8x-SE	3500	90	350	2232	2009	34.3	12	186
BXRC-35G20F0-C-8x-SE	3500	90	500	3177	2859	34.3	17.1	186
BXRC-40G20F0-B-8x-SE	4000	90	350	2255	2029	34.3	12	188
BXRC-40G20F0-C-8x-SE	4000	90	500	3210	2889	34.3	17.1	188
BXRC-50G20F0-B-8x-SE	5000	90	350	2188	1970	34.3	12	182
BXRC-50G20F0-C-8x-SE	5000	90	500	3114	2803	34.3	17.1	182

**Table 2:** Selection Guide, Stabilized DC Test Performance ( $T_c = 85^\circ\text{C}$ )<sup>4,5,6</sup>

Part Number	Nominal CCT (K)	CRI <sup>2</sup>	Nominal Drive Current <sup>3</sup> (mA)	Typical DC Flux <sup>4,5</sup> $T_c = 85^\circ\text{C}$ (lm)	Minimum DC Flux <sup>6</sup> $T_c = 85^\circ\text{C}$ (lm)	Typical $V_f$ (V)	Typical Power (W)	Typical Efficacy (lm/W)
BXRC-27G20F0-B-8x-SE	2700	90	350	1993	1794	33.4	11.7	170
BXRC-27G20F0-C-8x-SE	2700	90	500	2836	2553	33.4	16.7	170
BXRC-30G20F0-B-8x-SE	3000	90	350	2034	1831	33.4	11.7	174
BXRC-30G20F0-C-8x-SE	3000	90	500	2894	2605	33.4	16.7	173
BXRC-35G20F0-B-8x-SE	3500	90	350	2054	1848	33.4	11.7	176
BXRC-35G20F0-C-8x-SE	3500	90	500	2923	2631	33.4	16.7	175
BXRC-40G20F0-B-8x-SE	4000	90	350	2075	1867	33.4	11.7	177
BXRC-40G20F0-C-8x-SE	4000	90	500	2953	2657	33.4	16.7	177
BXRC-50G20F0-B-8x-SE	5000	90	350	2013	1812	33.4	11.7	172
BXRC-50G20F0-C-8x-SE	5000	90	500	2865	2579	33.4	16.7	172

Notes for Table 1 & 2:

1. Nominal CCT as defined by ANSI C78.377-2011.
2. CRI values are minimums and tested at  $T_j = T_c = 85^\circ\text{C}$ . Minimum Rg value for 90 CRI products is 50. Bridgelux maintains a  $\pm 3$  tolerance on CRI and Rg values.
3. Drive current is referred to as nominal drive current.
4. Products tested under pulsed condition (10ms pulse width) at nominal test current where  $T_j$  (junction temperature) =  $T_c$  (case temperature) =  $25^\circ\text{C}$ .
5. Typical performance values are provided as a reference only and are not a guarantee of performance.
6. Bridgelux maintains a  $\pm 7\%$  tolerance on flux measurements.
7. Minimum flux values at the nominal test current are guaranteed by 100% test.

# European Product Registry for Energy Labeling

The European Product Registry for Energy Labeling (EPREL) is defined in the EU Regulation 2017/1369 to provide important energy efficiency information to consumers. Together with Energy Labeling Regulation ELR (EU) 2019/2015 which was amended by regulation (EU) 2021/340 for energy labelling of light sources, manufacturers are required to declare an energy class based on key technical specifications from each of their product and register it in an open data base managed by EPREL. It is now a legal requirement for a vendor of light sources to upload information about their products into the EPREL database before placing these products on the market in the EU.

Table 3 below provides a list of part numbers that are in compliance with ELR and are currently listed in the EPREL database.

At Bridgelux, we are fully committed to supplying products that are compliant with pertinent laws, rules, and obligation imposed by relevant government bodies including the European Energy Labeling regulation. Customers can use these products with full confidence for any projects that fall under the ELR.

**Table 3:** Part numbers registered in European Product Registry for Energy Labeling

PART NUMBER <sup>1</sup>	CCT (K)	CRI	Current <sup>2</sup> (mA)	Vf (V)	Useful flux <sup>3</sup> ( $\Phi_{use}$ ) at 85C (lm)	Power (W)	Efficacy (lm/W)	Energy efficiency class <sup>4</sup> 	Registration No	URL to Product Information Sheet in EPREL Database
BXRC-27G20Fo-B-83-SE	2700	90	900	38.6	3908	35	112	F	1332513	<a href="https://eprelec.europa.eu/qr/1332513">https://eprelec.europa.eu/qr/1332513</a>
BXRC-27G20Fo-C-83-SE	2700	90	1260	38.0	5459	48	114	F	1332514	<a href="https://eprelec.europa.eu/qr/1332514">https://eprelec.europa.eu/qr/1332514</a>
BXRC-30G20Fo-B-83-SE	3000	90	900	38.6	3988	35	115	F	1232123	<a href="https://eprelec.europa.eu/qr/1232123">https://eprelec.europa.eu/qr/1232123</a>
BXRC-30G20Fo-C-83-SE	3000	90	1260	38.0	5570	48	116	F	1332517	<a href="https://eprelec.europa.eu/qr/1332517">https://eprelec.europa.eu/qr/1332517</a>
BXRC-35G20Fo-B-83-SE	3500	90	900	38.6	4027	35	116	F	1332519	<a href="https://eprelec.europa.eu/qr/1332519">https://eprelec.europa.eu/qr/1332519</a>
BXRC-35G20Fo-C-83-SE	3500	90	1260	38.0	5626	48	118	F	1332520	<a href="https://eprelec.europa.eu/qr/1332520">https://eprelec.europa.eu/qr/1332520</a>
BXRC-40G20Fo-B-83-SE	4000	90	900	38.6	4067	35	117	F	1232127	<a href="https://eprelec.europa.eu/qr/1232127">https://eprelec.europa.eu/qr/1232127</a>
BXRC-40G20Fo-C-83-SE	4000	90	1260	38.0	5682	48	119	F	1332523	<a href="https://eprelec.europa.eu/qr/1332523">https://eprelec.europa.eu/qr/1332523</a>
BXRC-50G20Fo-C-84-SE	5000	90	1260	38.0	5515	48	115	F	1332525	<a href="https://eprelec.europa.eu/qr/1332525">https://eprelec.europa.eu/qr/1332525</a>

Notes for Table 3:

1. All device listed here must be disposed as e-waste upon its end of life according to local country guideline in each country.
2. For information on performance values at alternative drive conditions, please refer to the Product Selection Guide, Absolute Maximum Rating Table and Performance Curves in this data sheet.
3. For a definition of useful luminous flux ( $\Phi_{use}$ ), please see the ELR regulations at <https://tinyurl.com/4b6zvt4m>.
4. EPREL requires an arrow symbol containing the letter of the energy efficiency class to be displayed, on technical promotional material. Refer to this energy efficiency class column for specific energy efficiency class on each part number.

# Performance at Commonly Used Drive Currents

Vero SE LED arrays are tested to the specifications shown using the nominal drive currents in Table 1. Vero SE may also be driven at other drive currents dependent on specific application design requirements. The performance at any drive current can be derived from the current vs. voltage characteristics shown in Figures 1& 2 and the flux vs. current characteristics shown in Figures 3 & 4. The performance at commonly used drive currents is summarized in Table 4.

**Table 4:** Product Performance at Commonly Used Drive Currents

Part Number	CRI	Drive Current <sup>1</sup> (mA)	Typical $V_f$ $T_c = 25^\circ\text{C}$ (V)	Typical Power $T_c = 25^\circ\text{C}$ (W)	Typical Flux <sup>2</sup> $T_c = 25^\circ\text{C}$ (lm)	Typical DC Flux <sup>3</sup> $T_c = 85^\circ\text{C}$ (lm)	Typical Efficacy $T_c = 25^\circ\text{C}$ (lm/W)
BXRC-27G20F0-B-8x-SE	90	175	33.0	5.8	1089	1002	188
		260	33.6	8.7	1619	1489	186
		<b>350</b>	<b>34.3</b>	<b>12.0</b>	<b>2167</b>	<b>1993</b>	<b>181</b>
		450	35.0	15.7	2756	2535	176
		700	36.6	25.6	4148	3816	162
		900	37.7	34.0	5177	4763	152
BXRC-27G20F0-C-8x-SE	90	250	33.0	8.2	1568	1443	191
		375	33.6	12.6	2353	2165	187
		<b>500</b>	<b>34.3</b>	<b>17.1</b>	<b>3083</b>	<b>2836</b>	<b>180</b>
		630	34.9	22.0	3889	3578	177
		1000	36.6	36.6	5959	5483	163
		1260	37.7	47.5	7305	6721	154
BXRC-30G20F0-B-8x-SE	90	175	33.0	5.8	1111	1022	192
		260	33.6	8.7	1652	1520	190
		<b>350</b>	<b>34.3</b>	<b>12.0</b>	<b>2211</b>	<b>2034</b>	<b>184</b>
		450	35.0	15.7	2813	2588	179
		700	36.6	25.6	4234	3895	165
		900	37.7	34.0	5283	4861	155
BXRC-30G20F0-C-8x-SE	90	250	33.0	8.2	1600	1472	195
		375	33.6	12.6	2401	2209	191
		<b>500</b>	<b>34.3</b>	<b>17.1</b>	<b>3146</b>	<b>2894</b>	<b>184</b>
		630	34.9	22.0	3968	3651	180
		1000	36.6	36.6	6082	5595	166
		1260	37.7	47.5	7454	6858	157
BXRC-35G20F0-B-8x	90	175	33.0	5.8	1122	1032	193
		260	33.6	8.7	1669	1535	192
		<b>350</b>	<b>34.3</b>	<b>12.0</b>	<b>2232</b>	<b>2054</b>	<b>186</b>
		450	35.0	15.7	2840	2613	181
		700	36.6	25.6	4276	3934	167
		900	37.7	34.0	5336	4909	157
BXRC-35G20F0-C-8x-SE	90	250	33.0	8.2	1616	1487	197
		375	33.6	12.6	2425	2231	192
		<b>500</b>	<b>34.3</b>	<b>17.1</b>	<b>3177</b>	<b>2923</b>	<b>186</b>
		630	34.9	22.0	4007	3687	182
		1000	36.6	36.6	6143	5651	168
		1260	37.7	47.5	7528	6926	158

Notes for Table 4:

1. Alternate drive currents in Table 4 are provided for reference only and are not a guarantee of performance.
2. Bridgelux maintains a  $\pm 7\%$  tolerance on flux measurements.
3. Typical stabilized DC performance values are provided as reference only and are not a guarantee of performance.

# Performance at Commonly Used Drive Currents

**Table 4:** Product Performance at Commonly Used Drive Currents (Continued)

Part Number	CRI	Drive Current <sup>1</sup> (mA)	Typical $V_f$ $T_c = 25^\circ\text{C}$ (V)	Typical Power $T_c = 25^\circ\text{C}$ (W)	Typical Flux <sup>2</sup> $T_c = 25^\circ\text{C}$ (lm)	Typical DC Flux <sup>3</sup> $T_c = 85^\circ\text{C}$ (lm)	Typical Efficacy $T_c = 25^\circ\text{C}$ (lm/W)
BXRC-40G20F0-B-8x-SE	90	175	33.0	5.8	1133	1042	195
		260	33.6	8.7	1686	1551	194
		<b>350</b>	<b>34.3</b>	<b>12.0</b>	<b>2255</b>	<b>2075</b>	<b>188</b>
		450	35.0	15.7	2868	2639	183
		700	36.6	25.6	4318	3972	169
		900	37.7	34.0	5389	4958	159
BXRC-40G20F0-C-8x-SE	90	250	33.0	8.2	1632	1501	199
		375	33.6	12.6	2449	2253	194
		<b>500</b>	<b>34.3</b>	<b>17.1</b>	<b>3210</b>	<b>2953</b>	<b>188</b>
		630	34.9	22.0	4047	3724	184
		1000	36.6	36.6	6203	5707	169
		1260	37.7	47.5	7603	6995	160
BXRC-50G20F0-B-8x-SE	90	175	33.0	5.8	1100	1012	190
		260	33.6	8.7	1636	1505	188
		<b>350</b>	<b>34.3</b>	<b>12.0</b>	<b>2188</b>	<b>2013</b>	<b>182</b>
		450	35.0	15.7	2784	2561	177
		700	36.6	25.6	4190	3855	164
		900	37.7	34.0	5230	4812	154
BXRC-50G20F0-C-8x-SE	90	250	33.0	8.2	1584	1457	193
		375	33.6	12.6	2377	2186	189
		<b>500</b>	<b>34.3</b>	<b>17.1</b>	<b>3114</b>	<b>2865</b>	<b>182</b>
		630	34.9	22.0	3928	3614	179
		1000	36.6	36.6	6021	5539	165
		1260	37.7	47.5	7379	6789	155

Notes for Table 4:

1. Alternate drive currents in Table 4 are provided for reference only and are not a guarantee of performance.
2. Bridgelux maintains a  $\pm 7\%$  tolerance on flux measurements.
3. Typical stabilized DC performance values are provided as reference only and are not a guarantee of performance.



# Electrical Characteristics

**Table 5:** Electrical Characteristics

Part Number	Drive Current (mA)	Forward Voltage Pulsed, $T_c = 25^\circ\text{C}$ (V) <sup>1, 2, 3, 8</sup>			Typical Coefficient of Forward Voltage <sup>4</sup> $\Delta V_f / \Delta T_c$ (mV/ $^\circ\text{C}$ )	Typical Thermal Resistance Junction to Case <sup>5,6</sup> $R_{j-c}$ ( $^\circ\text{C}/\text{W}$ )	Driver Selection Voltages <sup>7</sup> (V)	
		Minimum	Typical	Maximum			$V_f$ Min. Hot $T_c = 105^\circ\text{C}$ (V)	$V_f$ Max. Cold $T_c = -40^\circ\text{C}$ (V)
BXRC-xxx20Fo-B-8x-SE	350	32.2	34.3	36.3	-11	0.22	31.4	37.1
	900	35.5	37.7	40.0	-12	0.34	34.6	40.8
BXRC-xxx20Fo-C-8x-SE	500	32.2	34.3	36.3	-11	0.19	31.4	37.1
	1260	35.4	37.7	39.9	-12	0.29	34.6	40.7

Notes for Table 5:

- Parts are tested in pulsed conditions,  $T_c = 25^\circ\text{C}$ . Pulse width is 10ms.
- Voltage minimum and maximum are provided for reference only and are not a guarantee of performance.
- Bridgelux maintains a tester tolerance of  $\pm 0.10\text{V}$  on forward voltage measurements.
- Typical coefficient of forward voltage tolerance is  $\pm 0.1\text{mV}$  for nominal current.
- Thermal resistance values are based from test data of a 3000K 80 CRI product.
- Thermal resistance value was calculated using total electrical input power; optical power was not subtracted from input power. The thermal interface material used during testing is not included in the thermal resistance value.
- $V_f$  min hot and max cold values are provided as reference only and are not guaranteed by test. These values are provided to aid in driver design and selection over the operating range of the product.
- This product has been designed and manufactured per IEC 62031:2018. This product has passed dielectric withstand voltage testing at 1160 V. The working voltage designated for the insulation is 80V d.c. The maximum allowable voltage across the array must be determined in the end product application.

# Eye Safety

**Table 6:** Eye Safety Risk Group (RG) Classifications

Part Number	Drive Current (mA)	CCT <sup>3</sup>		
		2700K/3000K	4000K	5000K <sup>2</sup>
BXRC-xxx20F0-B-8x-SE	900	RG1	RG1	RG1
BXRC-xxx20F0-C-8x-SE	1110	RG1	RG1	RG1
	1260	RG1	RG1	RG2

Notes for Table 6:

1. Eye safety classification for the use of Bridgelux Vero SE LED arrays is in accordance with specification IEC/TR 62778: Application of IEC 62471 for the assessment of blue light hazard to light sources and luminaires.
2. For products classified as RG2 at 5000K Ethr= 1530 lx.
3. Please contact your Bridgelux sales representative for Ethr values at specific drive currents and CCTs not listed.

# Absolute Maximum Ratings

**Table 7:** Maximum Ratings

Parameter	Maximum Rating	
LED Junction Temperature (T <sub>J</sub> )	150°C	
Storage Temperature <sup>1</sup>	-40°C to +95°C	
Operating Case Temperature <sup>2</sup> (T <sub>C</sub> )	95°C	
Soldering Temperature <sup>3</sup>	300°C or lower for a maximum of 6 seconds	
	BXRC-xxx20Fo-B-8x-SE	BXRC-xxx20Fo-C-8x-SE
Maximum Drive Current <sup>4</sup>	900 mA at ≤85°C 675 mA at 95°C	1260 mA at ≤85°C 945 mA at 95°C
Maximum Peak Pulsed Drive Current <sup>5</sup>	1290 mA	1800 mA
Maximum Reverse Voltage <sup>6</sup>	-60V	-60V

Notes for Table 7:

1. The F90 product is robust enough to pass our internal humidity test but it is still more sensitive compared to regular LED array product. The product needs to be stored in a dry environment. It is not recommended to use the product in a damp environment that directly exposes it to moisture.
2. For IEC 62717 requirement, please consult your Bridgelux sales representative.
3. Refer to Bridgelux Application Note AN31: Bridgelux Vero SE Array Design Guide.
4. Arrays may be driven at higher currents however lumen maintenance may be reduced and warranty will not apply.
5. Bridgelux recommends a maximum duty cycle of 10% and pulse width of 20 ms when operating LED Arrays at maximum peak pulsed current specified. Maximum peak pulsed currents indicate values where LED Arrays can be driven without catastrophic failures.
6. Light emitting diodes are not designed to be driven in reverse voltage and will not produce light under this condition. Maximum rating provided for reference only.

# Performance Curves

**Figure 1: Vero SE 13B Drive Current vs. Voltage**

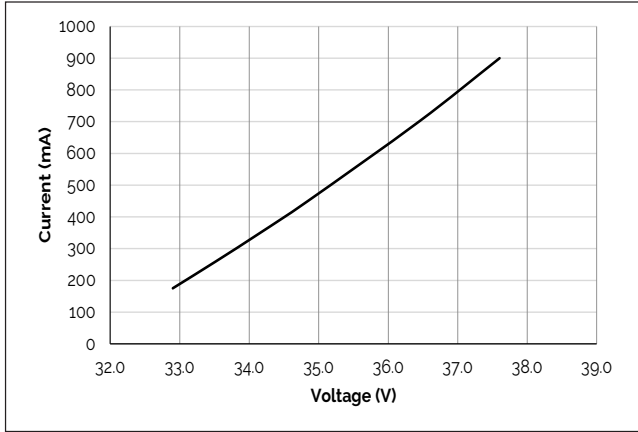

**Figure 2: Vero SE 13C Drive Current vs. Voltage**

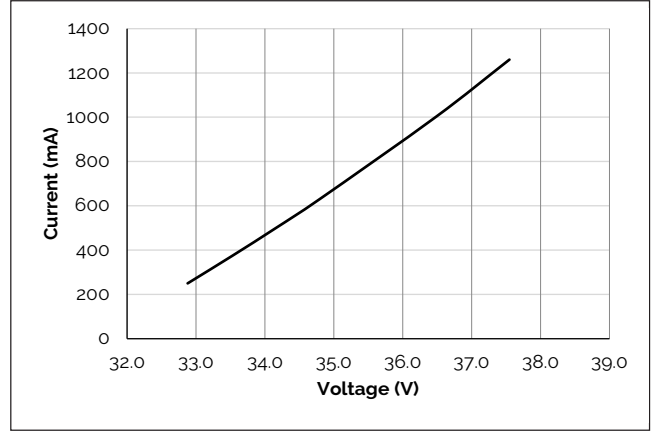

**Figure 3: Vero SE 13B Typical Relative Flux vs. Current**

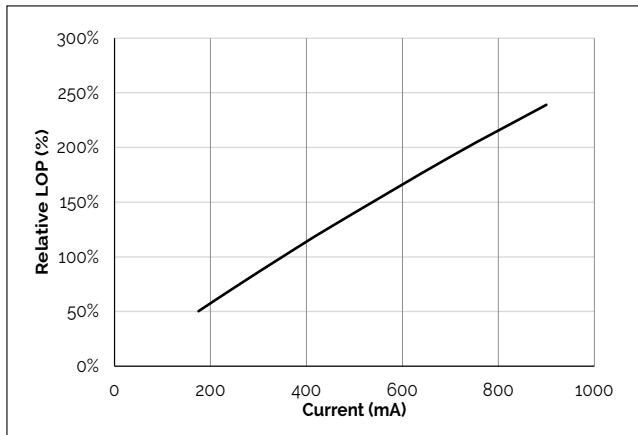

**Figure 4: Vero SE 13C Typical Relative Flux vs. Current**

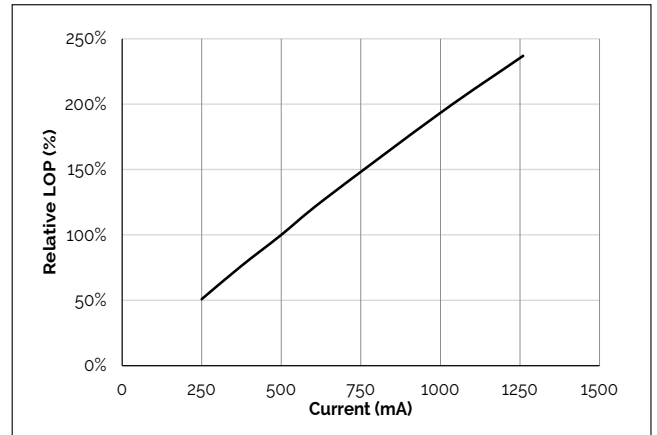

**Figure 5: Typical DC Flux vs. Case Temperature**

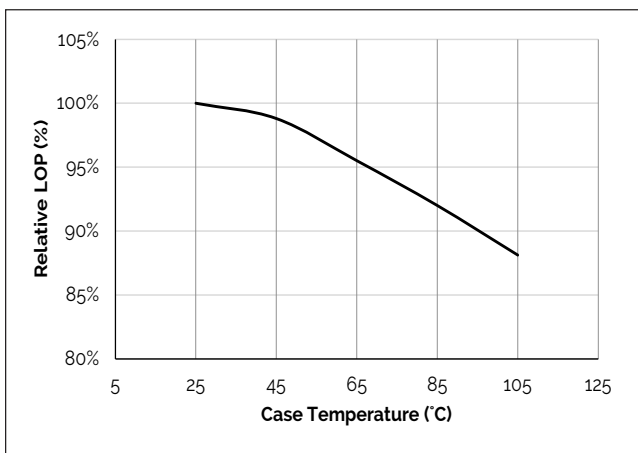

**Figure 6: Typical DC ccx Shift vs. Case Temperature**

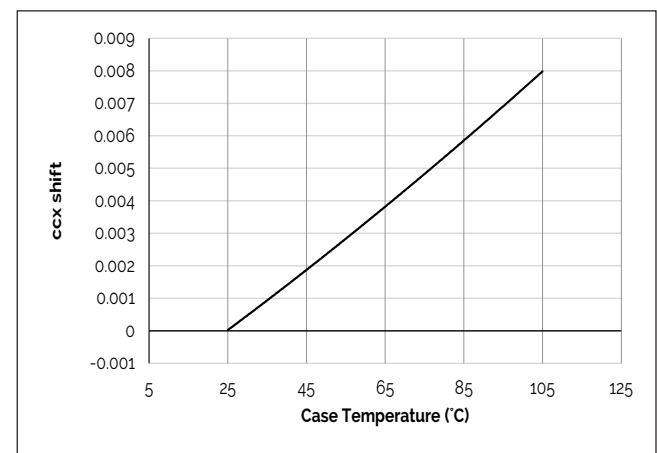

Notes for Figures 1-4:

1. Bridgelux does not recommend driving high power LEDs at low currents. Doing so may produce unpredictable results. Pulse width modulation (PWM) is recommended for dimming effects.
2. Products tested under pulsed condition (10ms pulse width) at nominal test current where  $T_j$  (junction temperature) =  $T_c$  (case temperature) = 25°C.

Note for Figures 5-6:

1. Characteristics shown for Warm White.

# Performance Curves

**Figure 7: Typical DC ccy Shift vs. Case Temperature**

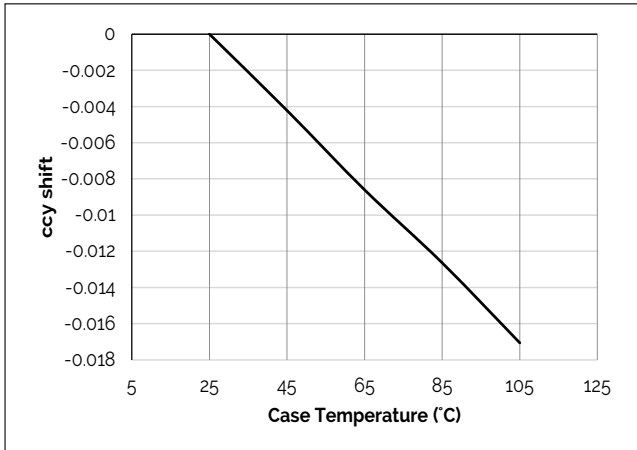

**Figure 8: Vero SE 13B Drive Current vs. ccx Shift**

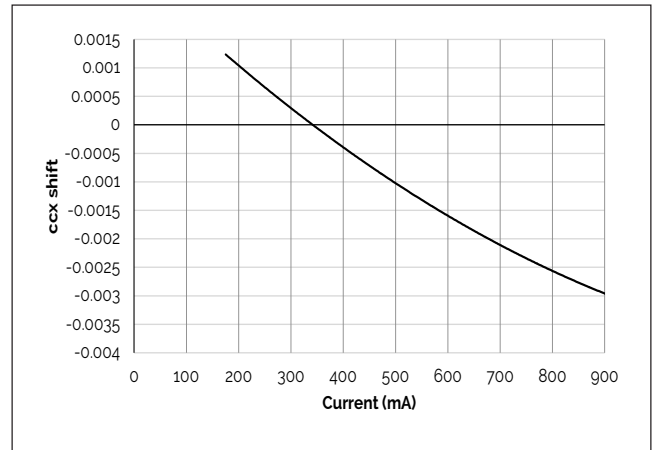

**Figure 9: Vero SE 13B Drive Current vs. ccy Shift**

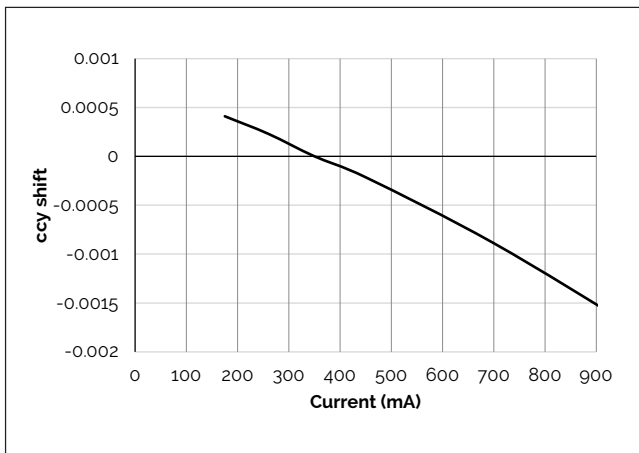

**Figure 10: Vero SE 13C Drive Current vs. ccx Shift**

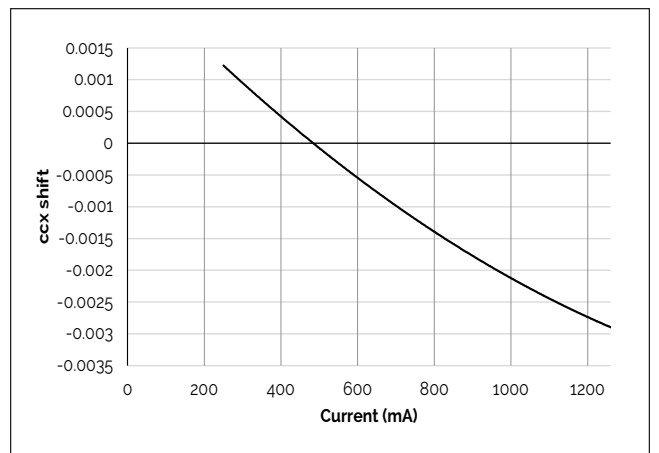

**Figure 11: VeroSE 13C Drive Current vs. ccy Shift**

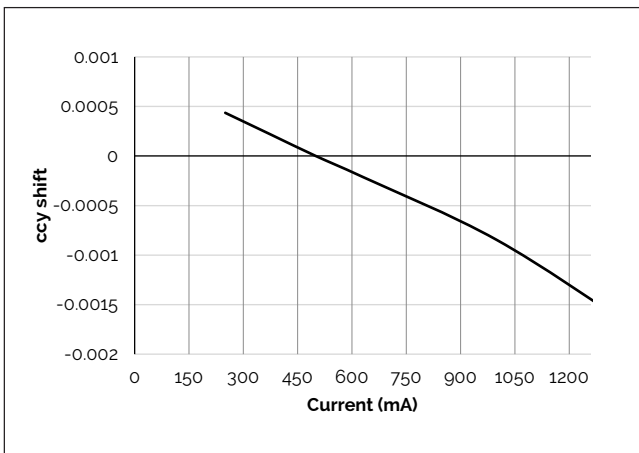

**Figure 12: Derating Curve**

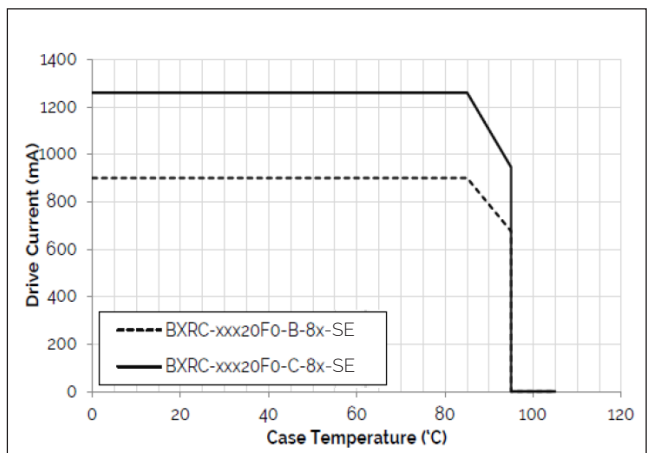

Note for Figures 7-11:

1. Characteristics shown for Warm White.

# Typical Radiation Pattern

**Figure 13: Typical Spatial Radiation Pattern**

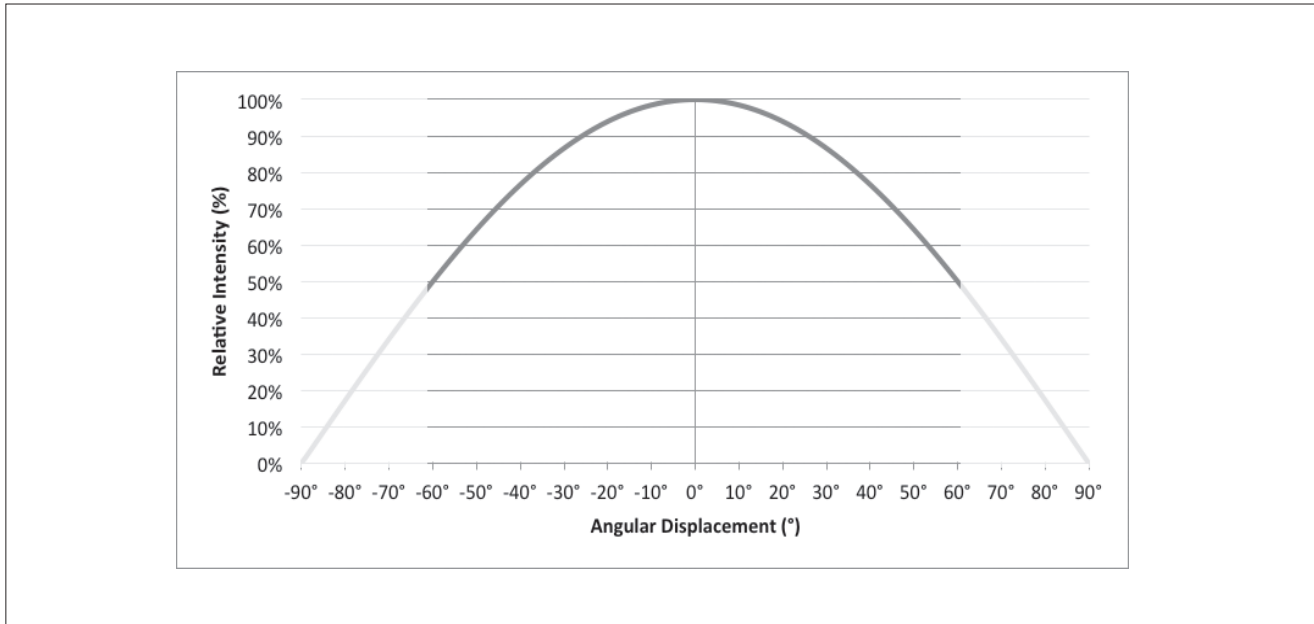

Notes for Figure 13:

1. Typical viewing angle is 120°.
2. The viewing angle is defined as the off axis angle from the centerline where intensity is ½ of the peak value.

**Figure 14: Typical Polar Radiation Pattern**

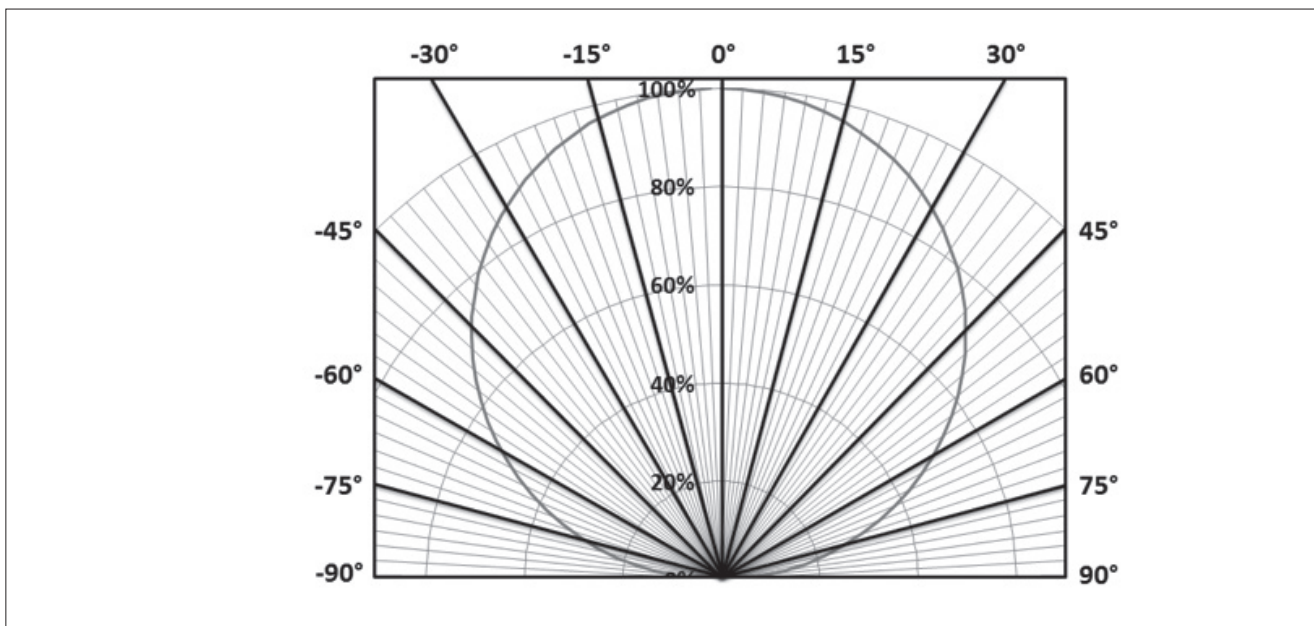

# Typical Color Spectrum

Figure 15: Typical Color Spectrum

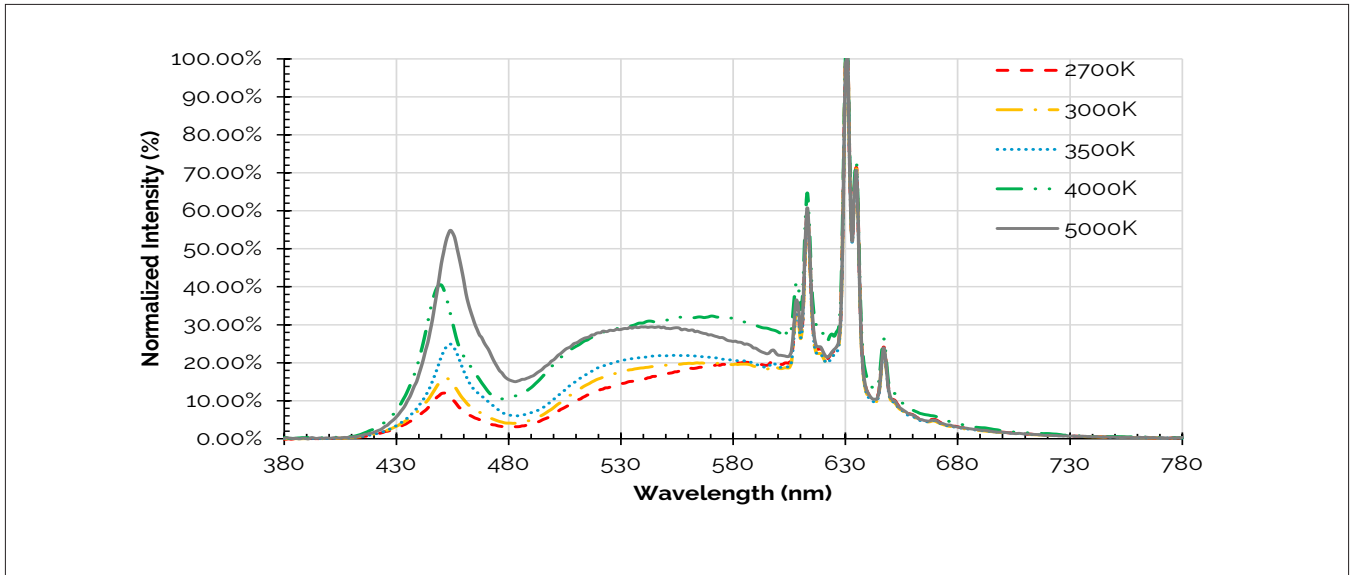

Notes for Figure 15:

1. Color spectra measured at nominal current for  $T_j = T_c = 85^\circ\text{C}$ .
2. Color spectra shown is 2700K and 90CRI.
3. Color spectra shown is 3000K and 90 CRI.
4. Color spectra shown is 3500K and 90 CRI.
5. Color spectra shown is 4000K and 90 CRI.
6. Color spectra shown is 5000K and 90 CRI.

# Color Binning Information

**Figure 16: Warm, Neutral and Cool White Test Bins in xy Color Space**

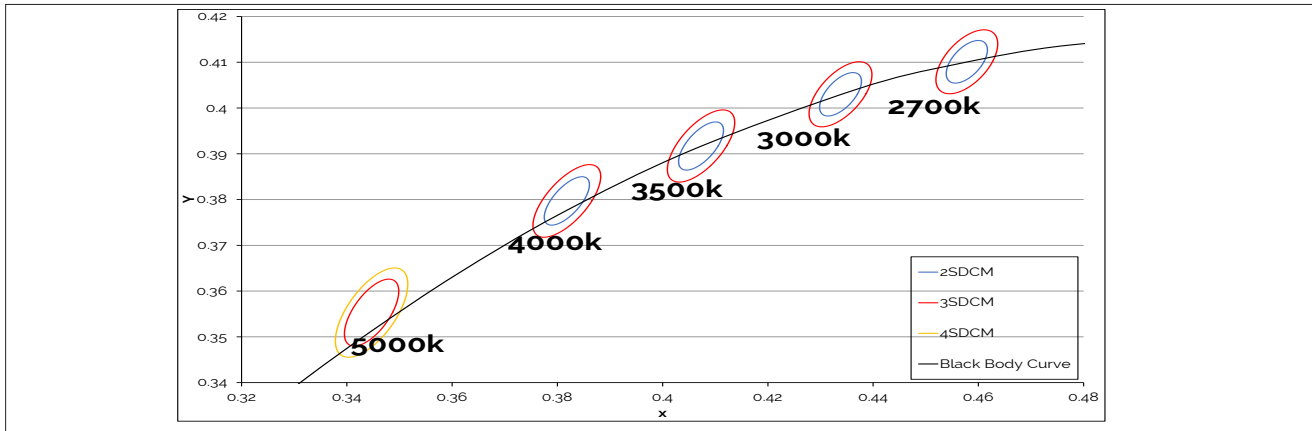

Note: Pulsed Test Conditions,  $T_c = 85^\circ\text{C}$

**Table 8: Warm and Neutral White xy Bin Coordinates and Associated Typical CCT (product is hot targeted to  $T_c = 85^\circ\text{C}$ )**

Bin Code	2700K	3000K	3500K	4000K
ANSI Bin (for reference only)	(2580K - 2870K)	(2870K - 3220K)	(3220K - 3710K)	(3710K - 4260K)
83 (3 SDCM)	(2651K - 2794K)	(2968K - 3136K)	(3369K - 3586K)	(3851K - 4130K)
82 (2 SDCM)	(2674K - 2769K)	(2995K - 3107K)	(3404K - 3548K)	(3895K - 4081K)
Center Point (x,y)	(0.4578, 0.4101)	(0.4338, 0.403)	(0.4073, 0.3917)	(0.3818, 0.3797)

**Table 9: Cool White xy Bin Coordinates and Associated Typical CCT (product is hot targeted to  $T_c = 85^\circ\text{C}$ )**

Bin Code	5000K
ANSI Bin (for reference only)	(4745K - 5311K)
84 (4 SDCM)	(4801K - 5282K)
83 (3 SDCM)	(4835K - 5215K)
Center Point (x,y)	(0.3447, 0.3553)

Note for Tables 8-g:

1. Bridgelux maintains a tolerance of +/- 0.007 on x and y color coordinates in the CIE 1931 color Space.



# Mechanical Dimensions

**Figure 17: Drawing for Vero SE 13 LED Array**

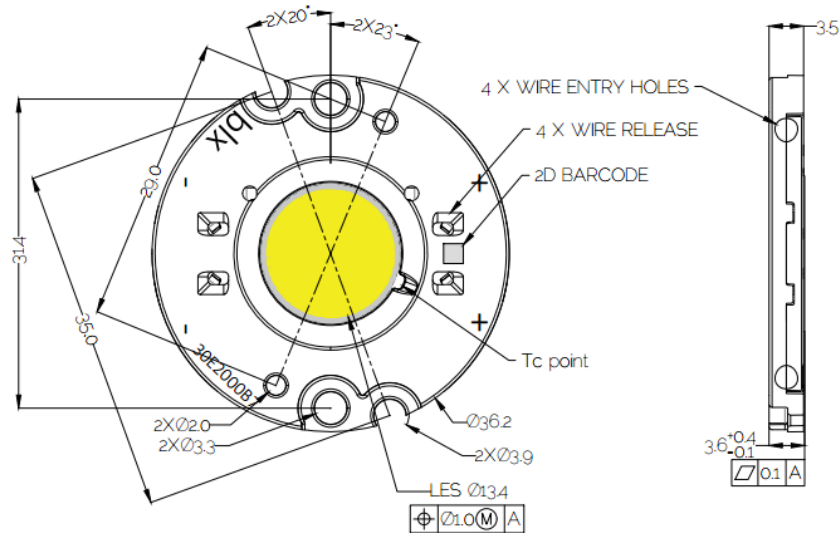

Notes for Figure 17:

1. Drawings are not to scale.
2. Dimensions are in mm.
3. Unless otherwise specified, tolerances are  $\pm 0.10\text{mm}$ .
4. Mounting holes (2X) are for M3 screws.
5. Bridgelux recommends two tapped holes for mounting screws with  $19.0 \pm 0.10\text{mm}$  center-to-center spacing.
6. Screws with flat shoulders (pan, dome, button, round, truss, mushroom) provide optimal torque control. Do NOT use flat, countersink, or raised head screws.
7. The optical center of the LED Array is nominally defined by the mechanical center of the array to a tolerance of  $\pm 0.2\text{mm}$ .
8. Bridgelux maintains a flatness of 0.10mm across the mounting surface of the array.

# Packaging and Labeling

Figure 18: Drawing for Vero SE 13 Packaging Tray

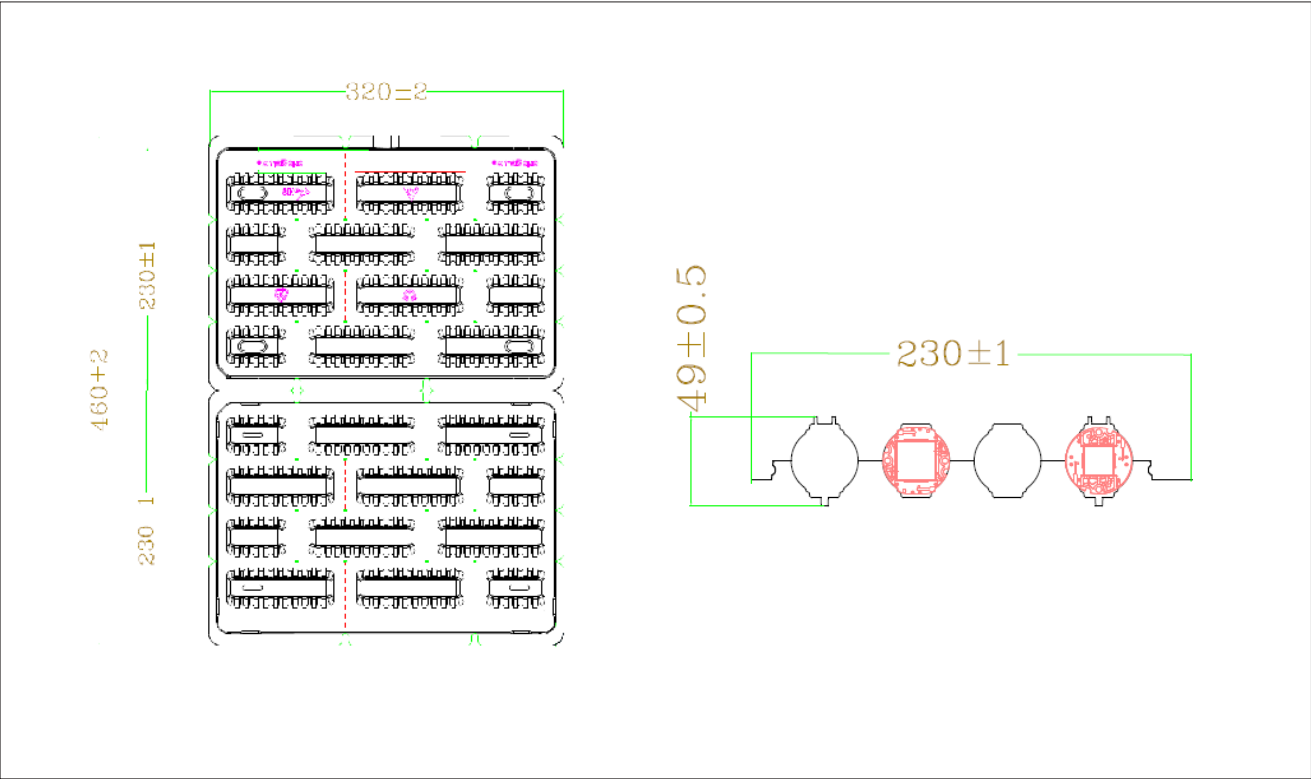

- Notes for Figure 18:
1. Dimensions are in millimeters.
  2. Drawings are not to scale.

# Packaging and Labeling

Figure 19: Vero SE Series Packaging and Labeling

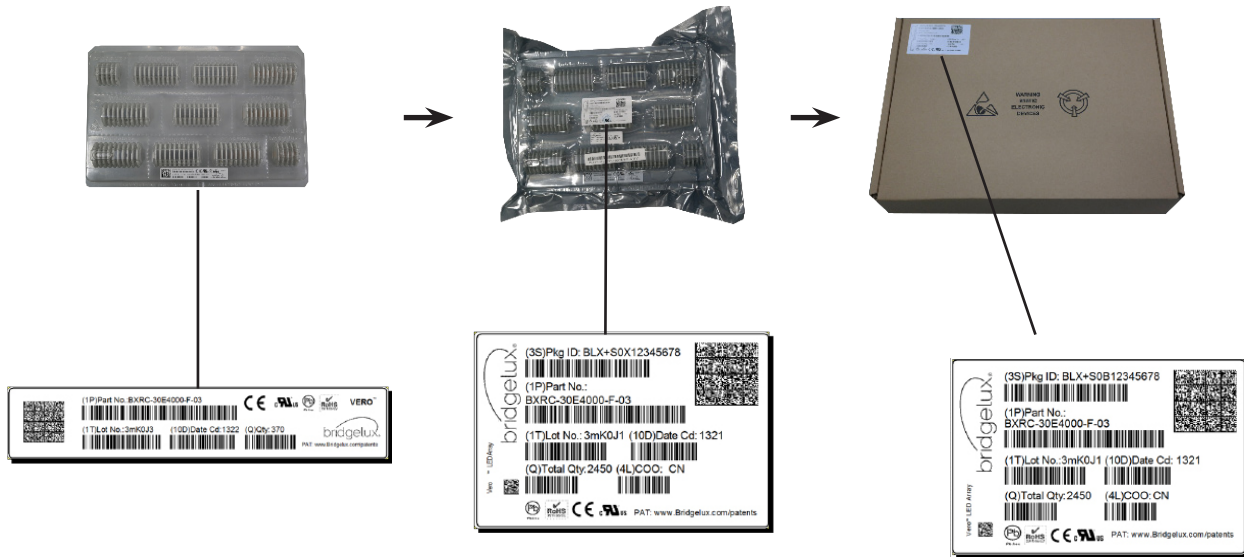

Notes for Figure 19:

1. Each tray holds 100 COBs.
2. Each tray is vacuum sealed in an anti-static bag and placed in its own box.
3. Each tray, bag and box is to be labeled as shown above.

Figure 20: Product Labeling

Bridgelux COB arrays have laser markings on the back side of the substrate to help with product identification. In addition to the product identification markings, Bridgelux COB arrays also contain markings for internal Bridgelux manufacturing use only. The image below shows which markings are for customer use and which ones are for Bridgelux internal use only. The Bridgelux internal manufacturing markings are subject to change without notice, however these will not impact the form, function or performance of the COB array.



# Design Resources

## Application Notes

Bridgelux has developed a comprehensive set of application notes and design resources to assist customers in successfully designing with the Vero SE product family of LED array products. For all available application notes visit [www.bridgelux.com](http://www.bridgelux.com).

## Optical Source Models

Optical source models and ray set files are available for all Bridgelux products. For a list of available formats, visit [www.bridgelux.com](http://www.bridgelux.com).

## 3D CAD Models

Three dimensional CAD models depicting the product outline of all Bridgelux Vero SE LED arrays are available in both IGS and STEP formats. Please contact your Bridgelux sales representative for assistance.

## LM80

LM80 testing has been completed and the LM80 report is now available. Please contact your Bridgelux sales representative for LM-80 report.

# Precautions

## CAUTION: CHEMICAL EXPOSURE HAZARD

Exposure to some chemicals commonly used in luminaire manufacturing and assembly can cause damage to the LED array. Please consult Bridgelux Application Note AN120 for additional information.

## CAUTION: RISK OF BURN

Do not touch the Vero SE LED array during operation. Allow the array to cool for a sufficient period of time before handling. The Vero SE LED array may reach elevated temperatures such that could burn skin when touched.

## CAUTION

### CONTACT WITH LIGHT EMITTING SURFACE (LES)

Avoid any contact with the LES. Do not touch the LES of the LED array or apply stress to the LES (yellow phosphor resin area). Contact may cause damage to the LED array.

Optics and reflectors must not be mounted in contact with the LES (yellow phosphor resin area). Optical devices may be mounted on the top surface of the plastic housing of the Vero SE LED array. Use the mechanical features of the LED array housing, edges and/or mounting holes to locate and secure optical devices as needed.

# Disclaimers

## MINOR PRODUCT CHANGE POLICY

The rigorous qualification testing on products offered by Bridgelux provides performance assurance. Slight cosmetic changes that do not affect form, fit, or function may occur as Bridgelux continues product optimization.

## STANDARD TEST CONDITIONS

Unless otherwise stated, array testing is performed at the nominal drive current.

# About Bridgelux: Bridging Light and Life™

At Bridgelux, we help companies, industries and people experience the power and possibility of light. Since 2002, we've designed LED solutions that are high performing, energy efficient, cost effective and easy to integrate. Our focus is on light's impact on human behavior, delivering products that create better environments, experiences and returns—both experiential and financial. And our patented technology drives new platforms for commercial and industrial luminaires.

**For more information about the company, please visit**

**[bridgelux.com](http://bridgelux.com)**

**[twitter.com/Bridgelux](https://twitter.com/Bridgelux)**

**[facebook.com/Bridgelux](https://facebook.com/Bridgelux)**

**[linkedin.com/company/bridgelux-inc-\\_2](https://linkedin.com/company/bridgelux-inc-_2)**

**[youtube.com/user/Bridgelux](https://youtube.com/user/Bridgelux)**

**WeChat ID: BridgeluxInChina**



46410 Fremont Boulevard

Fremont, CA 94538 USA

Tel (925) 583-8400

**[www.bridgelux.com](http://www.bridgelux.com)**