

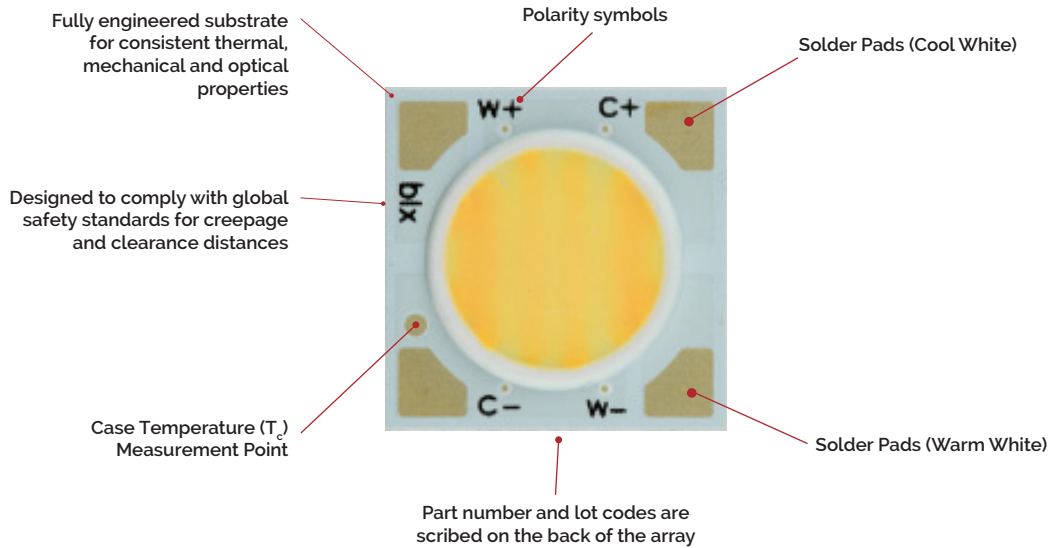
# Bridgelux® Vesta® Series Tunable White Gen 2 9mm Array, 90 CRI and Thrive™

Product Data Sheet DS350



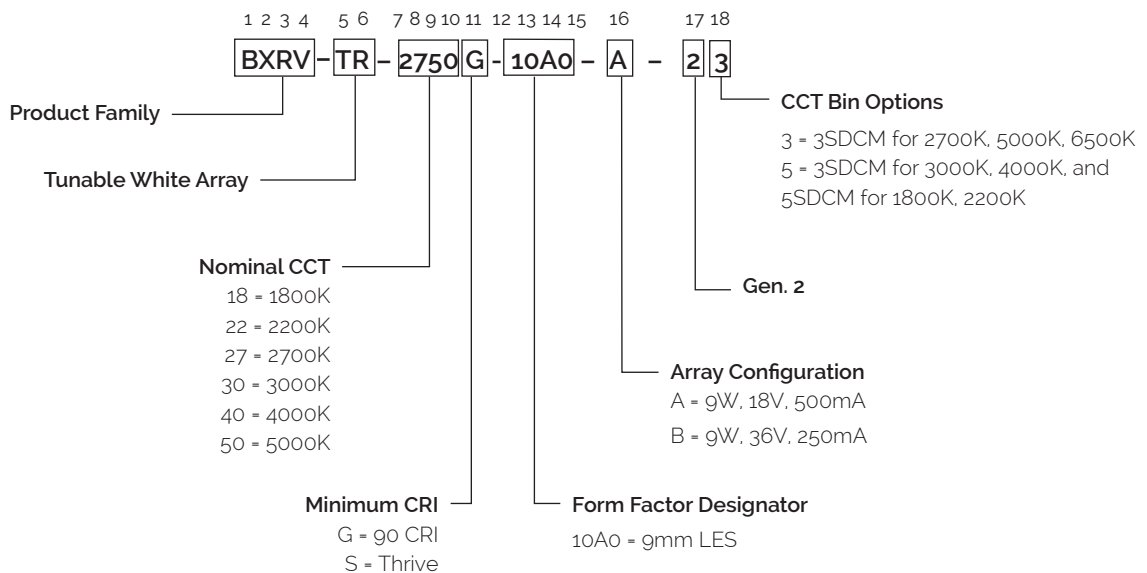
# Product Feature Map

Bridgelux arrays are fully engineered devices that provide consistent thermal and optical performance on an engineered mechanical platform. The arrays incorporate several features to simplify design integration and assembly. Please visit [www.bridgelux.com](http://www.bridgelux.com) for more information on the Vesta Series family of products.



## Product Nomenclature

The part number designation for Bridgelux Vesta Series arrays is explained as follows:



# Product Selection Guide

The following product configurations are available:

**Table 1:** Selection Guide, Measurement Data

Part Number	Nominal CCT <sup>1</sup> T <sub>c</sub> =85°C (K)	Typical CRI <sup>2</sup> T <sub>c</sub> =85°C	Nominal Drive Current per channel (mA)	Typical V <sub>f</sub> <sup>3</sup> T <sub>c</sub> =25°C (V)	Typical Power T <sub>c</sub> =25°C (W)	Typical Pulsed Flux <sup>3,4,5</sup> T <sub>c</sub> =25°C (lm)	Typical Efficacy T <sub>c</sub> =25°C <sup>5</sup> (lm/W)	Minimum Pulsed Flux T <sub>c</sub> =25°C <sup>8</sup> (lm)	Typical DC Flux T <sub>c</sub> =85°C <sup>6,7</sup> (lm)
BXRV-TR-2750G-10A0-A-23	2700	93	500	17.6	8.8	950	108	855	846
	5000	92	500	18.2	9.1	1100	121	990	968
BXRV-TR-2765G-10A0-A-23	2700	93	500	17.6	8.8	950	108	855	846
	6500	92	500	18.2	9.1	1110	122	999	977
BXRV-TR-2765S-10A0-A-23	2700	98, Thrive	500	17.6	8.8	842	96	758	749
	6500	98, Thrive	500	18.2	9.1	995	109	895	875
BXRV-TR-2750G-10A0-B-23	2700	93	250	35.1	8.8	950	108	855	846
	5000	92	250	35.1	8.8	1120	128	1008	986
BXRV-TR-2765G-10A0-B-23	2700	93	250	35.1	8.8	950	108	855	846
	6500	92	250	35.1	8.8	1130	129	1017	994
BXRV-TR-2750S-10A0-B-23	2700	98, Thrive	250	35.1	8.8	842	96	758	749
	5000	98, Thrive	250	35.1	8.8	1003	114	903	903
BXRV-TR-2765S-10A0-B-23	2700	98, Thrive	250	35.1	8.8	842	96	758	749
	6500	98, Thrive	250	35.1	8.8	1012	115	911	910
BXRV-TR-1830G-10A0-B-25	1800	92	250	35.1	8.8	650	74	585	579
	3000	92	250	35.1	8.8	1000	114	900	880
BXRV-TR-1840G-10A0-A-25	1800	93	500	17.6	8.8	660	75	594	587
	4000	92	500	18.2	9.1	1060	116	954	933
BXRV-TR-1840S-10A0-A-25	1800	92	500	17.6	8.8	660	75	594	587
	4000	98, Thrive	500	18.2	9.1	954	105	859	840
BXRV-TR-1840G-10A0-B-25	1800	92	250	36.0	9.0	700	78	630	623
	4000	92	250	36.0	9.0	1100	122	990	979
BXRV-TR-2250G-10A0-A-25	2200	92	500	17.6	8.8	820	93	738	722
	5000	92	500	18.2	9.1	1100	121	990	968
BXRV-TR-2250G-10A0-B-25	2200	92	250	35.1	8.8	820	93	738	722
	5000	92	250	35.1	8.8	1120	128	1008	986

**Notes for Table 1:**

- Nominal CCT as defined by ANSI C78.377-2011.
- For CRI 92-93 products, the minimum CRI value is 90 and the minimum Rg value is 50. For CRI 98 Thrive products, the minimum CRI value is 95, Bridgelux maintains a ±3 tolerance on all Rg values.
- Products tested under pulsed condition (10ms pulse width) at nominal test current where T<sub>j</sub> (junction temperature) - T<sub>c</sub> (case temperature) = 25°C.
- Typical performance values are provided as a reference only and are not a guarantee of performance.
- Bridgelux maintains a ±7% tolerance on flux measurements.
- Typical stabilized DC performance values are provided as reference only and are not a guarantee of performance.
- Typical performance is estimated based on operation under DC (direct current) with LED array mounted onto a heat sink with thermal interface material and the case temperature maintained at 85°C. Based on Bridgelux test setup, values may vary depending on the thermal design of the luminaire and/or the exposed environment to which the product is subjected.
- Minimum flux values at pulsed nominal test current are guaranteed by 100% test.

# European Product Registry for Energy Labeling

The European Product Registry for Energy Labeling (EPREL) is defined in the EU Regulation 2017/1369 to provide information about a product's energy efficiency to consumers. Together with Energy Labeling Regulation ELR (EU) 2019/2015, which was amended by regulation (EU) 2021/340 for energy labelling of light sources, manufacturers are required to declare an energy class based on key technical specifications from each of their product and register it in an open data base managed by EPREL. It is now a legal requirement for a vendor of light sources to upload information about their products into the EPREL database before placing these products on the market in the EU.

Table 2 provides a list of part numbers that are in compliance with EPREL regulations and are currently listed in the EPREL database.

At Bridgelux, we are fully committed to supplying products that are compliant with pertinent laws, rules, and obligation imposed by relevant government bodies including the ELR regulation. Customers can use these products with full confidence for any projects that fall under the EPREL requirement.

**Table 2:** Table of products registered in the European Product Registry for Energy Labeling (EPREL)

Part Number	CCT (K)	CRI	Current <sup>3</sup> (mA)	Voltage <sup>3</sup> (V)	Useful Flux <sup>2</sup> $\Phi_{\text{useful}}$ Tc=85C (lm)	Power (W)	Efficacy (lm/W)	Energy Efficiency Class <sup>4</sup>	Registration No	URL <sup>1</sup>
BXRV-TR-2750G-10A0-A-23	5000	90	700	17.8	1287	12	103	F	876356	<a href="https://eprelec.europa.eu/qr/876356">https://eprelec.europa.eu/qr/876356</a>
BXRV-TR-2765G-10A0-A-23	6500	90	700	17.8	1299	12	104	F	879091	<a href="https://eprelec.europa.eu/qr/879091">https://eprelec.europa.eu/qr/879091</a>
BXRV-TR-2765S-10A0-A-23	6500	97	620	17.5	1021	11	94	F	1214081	<a href="https://eprelec.europa.eu/qr/1214081">https://eprelec.europa.eu/qr/1214081</a>
BXRV-TR-2750G-10A0-B-23	5000	90	480	34.3	1735	16	105	F	876359	<a href="https://eprelec.europa.eu/qr/876359">https://eprelec.europa.eu/qr/876359</a>
BXRV-TR-2765G-10A0-B-23	6500	90	480	34.3	1750	16	106	F	879094	<a href="https://eprelec.europa.eu/qr/879094">https://eprelec.europa.eu/qr/879094</a>
BXRV-TR-2750S-10A0-B-23	5000	97	400	33.5	1302	13	97	F	876385	<a href="https://eprelec.europa.eu/qr/876385">https://eprelec.europa.eu/qr/876385</a>
BXRV-TR-2765S-10A0-B-23	6500	97	420	33.7	1386	14	98	F	876388	<a href="https://eprelec.europa.eu/qr/876388">https://eprelec.europa.eu/qr/876388</a>
BXRV-TR-1830G-10A0-B-25	3000	90	290	32.3	888	9	95	F	876324	<a href="https://eprelec.europa.eu/qr/876324">https://eprelec.europa.eu/qr/876324</a>
BXRV-TR-1840G-10A0-A-25	4000	90	700	17.8	1241	12	99	F	876335	<a href="https://eprelec.europa.eu/qr/876335">https://eprelec.europa.eu/qr/876335</a>
BXRV-TR-1840S-10A0-A-25	4000	97	510	17.1	788	9	90	G	876346	<a href="https://eprelec.europa.eu/qr/876346">https://eprelec.europa.eu/qr/876346</a>
BXRV-TR-1840G-10A0-B-25	4000	90	480	34.3	1723	16	105	F	876338	<a href="https://eprelec.europa.eu/qr/876338">https://eprelec.europa.eu/qr/876338</a>
BXRV-TR-2250G-10A0-A-25	5000	90	700	17.8	1287	12	103	F	1442022	<a href="https://eprelec.europa.eu/qr/1442022">https://eprelec.europa.eu/qr/1442022</a>

Notes for Table 2:

1. The performance data in this table is a subset of the data that was submitted to EPREL for obtaining the energy class listed here. For accessing a complete set of technical documentation of Bridgelux registered products in the EPREL database, please visit one of the hyperlinks listed above.
2. For a definition of useful luminous flux ( $\Phi_{\text{useful}}$ ), please see the ELR regulations at <https://tinyurl.com/4b6zvt4m>.
3. For information on performance values at alternative drive conditions, please refer to the Product Selection Guide, Absolute Maximum Rating Table and Performance Curves in this data sheet.
4. EPREL requires a symbol for displaying the energy classification of a product in marketing literature. This symbol consists of a letter stating a product's energy efficiency class inside a specific arrow logo as defined by EPREL.

# CRI and TM30 Characteristics for Vesta Arrays with Thrive

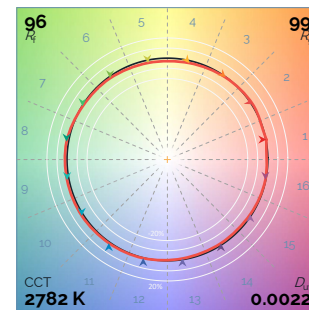
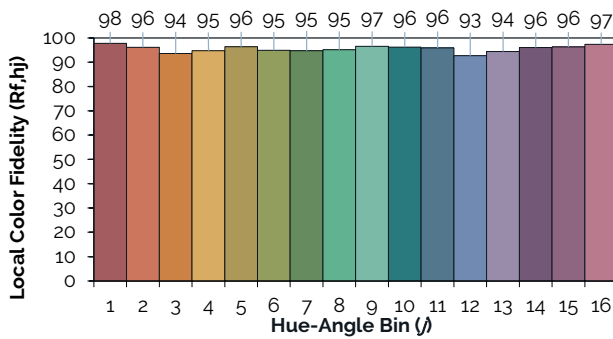
**Table 3:** Typical Color Rendering Index and TM-30 Values at  $T_c=85^\circ\text{C}$

Nominal CCT <sup>1</sup>	R <sub>f</sub>	R <sub>g</sub>	R <sub>a</sub>	R <sub>1</sub>	R <sub>2</sub>	R <sub>3</sub>	R <sub>4</sub>	R <sub>5</sub>	R <sub>6</sub>	R <sub>7</sub>	R <sub>8</sub>	R <sub>9</sub>	R <sub>10</sub>	R <sub>11</sub>	R <sub>12</sub>	R <sub>13</sub>	R <sub>14</sub>	R <sub>15</sub>
2700K	96	99	98	96	98	97	94	96	95	98	98	97	95	91	92	96	97	97
4000K	97	101	97	96	98	98	97	97	97	99	97	92	97	95	96	97	98	96
5000K	96	99	98	98	98	98	95	98	96	97	97	95	96	97	91	97	98	96
6500K	96	99	98	98	98	99	97	98	98	99	98	95	96	98	93	98	99	96

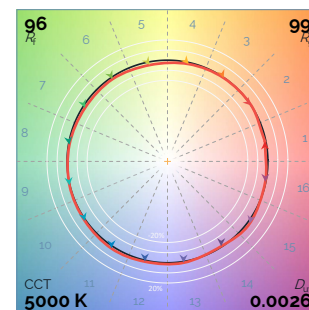
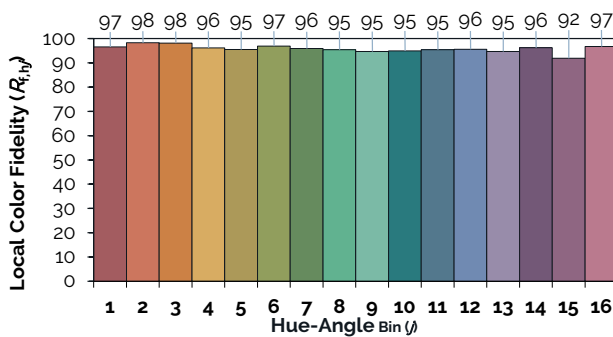
Note for Table 3:

1. Applicable for part numbers BXRV-TR-xxxxS-10A0-x-2x with the Thrive spectrum
2. Bridgelux maintains a tolerance of  $\pm 3$  on Color Rendering Index R1-R15 measurements and TM-30 measurements.

**Figure 1: 2700K Thrive TM-30 Graphs**



**Figure 2: 5000K Thrive TM-30 Graphs**



# TM30 Characteristics for Vesta Arrays with Thrive

Figure 3: 6500K Thrive TM-30 Graphs

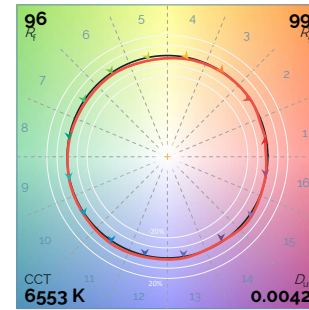
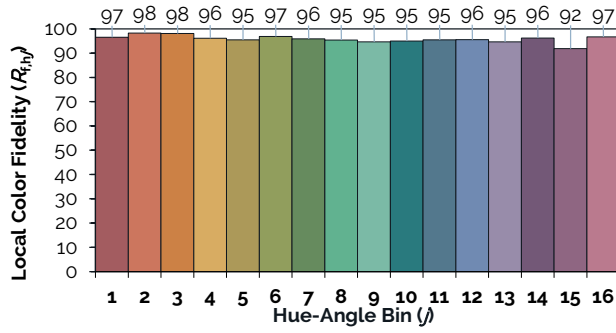
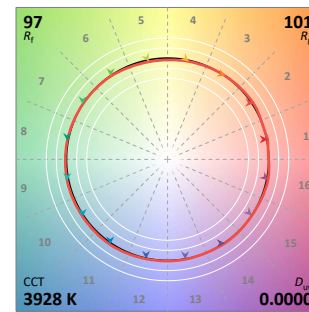
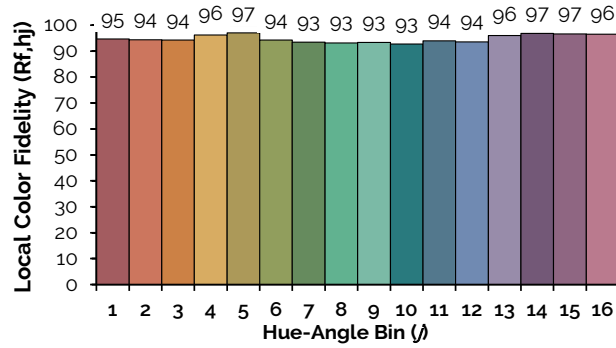


Figure 4: 4000K Thrive TM-30 Graphs



# Average Spectral Difference

## Spectral Matching to Natural Light

The lighting market is in the early stages of adoption of human-centric lighting (HCL). HCL encompasses the effects of lighting on the physical and emotional health and well-being of people. Throughout evolution, the human visual system has evolved under the natural light of sun and fire. These light sources have standardized industry spectral power definitions that describe the state of natural light. However, conventional metrics such as CCT, CRI, and TM-30 fail to adequately quantify the naturalness, or closeness of these light sources to the standardized natural spectra. Due to a lack of an industry standard metric to quantitatively measure the naturalness of a light source, Bridgelux has pioneered a new metric that takes the guesswork out of comparing LED light sources to natural light.

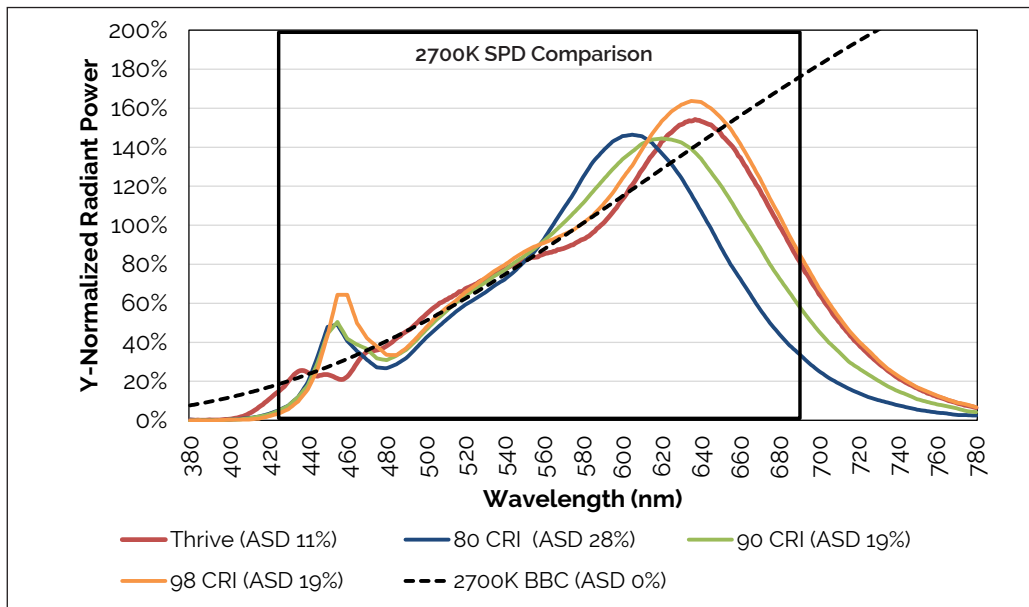
Average Spectral Difference, or ASD, is calculated by measuring the absolute difference between two spectra at discrete wavelengths. These values are averaged across a wavelength range derived from the photopic response curve, or  $V(\lambda)$ ; a luminous efficiency function describing the average spectral sensitivity of human perception of brightness. The range of 425nm to 690nm was selected to remove the tails of the  $V(\lambda)$  gaussian distribution below 1% of the peak value at 555nm, covering 99.9% of the area under the photopic response curve. Natural light is defined following the approach of IES TM-30; black body curves for light sources of  $\leq 4000K$  and the CIE standard illuminant D for light sources of  $\geq 5000K$ .

Natural light has an ASD of 0%; lower ASD values indicate a closer match to natural light. Thrive is engineered to provide the closest match to natural light available using proprietary chip, phosphor and packaging technology, resulting in an ASD between 8% to 11% for all CCTs used in Vesta products. By comparison, standard 80, 90, and 98 CRI light sources have ASD values that are 100% to 300% larger than Thrive. To learn more about the ASD metric, please review the Bridgelux whitepaper: Average Spectral Difference, a new method to make objective comparisons of naturalness between light sources; or contact your Bridgelux sales representative.

**Table4:** Typical ASD Values at  $T_c = 85^\circ C$

Nominal CCT	ASD
2700K	11%
4000K	6%
5000K	9%
6500K	8%

**Figure 5: SPD Comparison**



# Electrical Characteristics

**Table 5:** Electrical Characteristics

Part Number	CCT $T_c = 85^\circ\text{C}$ (K)	Nominal Drive Current (mA)	Forward Voltage Pulsed, $T_c = 25^\circ\text{C}$ (V) <sup>1,2,3,7</sup>			Typical Tem- perature Coefficient of Forward Voltage <sup>4</sup> $\Delta V_f / \Delta T_c$ (mV/ $^\circ\text{C}$ )	Typical Thermal Resistance Junction to Case <sup>5</sup> $R_{j-c}$ ( $^\circ\text{C}/\text{W}$ )	Driver Selection Voltages <sup>6</sup> (V)	
			Minimum	Typical	Maximum			$V_f$ Min. Hot $T_c = 105^\circ\text{C}$ (V)	$V_f$ Max. Cold $T_c = -40^\circ\text{C}$ (V)
BXRV-TR-xxxxX-10A0-A-2x	1800, 2200/2700	500	16.5	17.6	18.7	-5.9	0.91	16.1	19.0
	4000, 5000/6500	500	17.1	18.2	19.3	-5.9		16.6	19.7
BXRV-TR-xxxxX-10A0-B-2x	1800, 2700	250	33.0	35.1	37.2	-12.8	0.86	32.0	38.0
	3000, 5000/6500	250	33.0	35.1	37.2	-12.8		32.0	38.0
BXRV-TR-1840G-10A0-B-25	1800	250	33.8	36.0	38.2	-11.1	1.00	32.9	38.9
	4000	250	33.8	36.0	38.2	-10.9		32.8	39.0

Notes for Table 5:

1. Parts are tested in pulsed conditions,  $T_c = 25^\circ\text{C}$ . Pulse width is 10ms.
2. Voltage minimum and maximum are provided for reference only and are not a guarantee of performance.
3. Bridgelux maintains a tester tolerance of  $\pm 0.10\text{V}$  on forward voltage measurements.
4. Typical temperature coefficient of forward voltage tolerance is  $\pm 0.1\text{mV}$  for nominal current.
5. Thermal resistance value was calculated using total electrical input power; optical power was not subtracted from input power. The thermal interface material used during testing is not included in the thermal resistance value.
6.  $V_f$  min hot and max cold driver selection voltages are provided as reference only and are not guaranteed by test. These values are provided to aid in driver design and selection over the operating range of the product.
7. This product has been designed and manufactured per IEC 62031:2018. This product has passed dielectric withstand voltage testing at 500 V. The working voltage designated for the insulation of the dielectric layer is 60V DC. The maximum allowable voltage across the array must be determined in the end product application.



# Absolute Maximum Ratings

**Table 6:** Maximum Ratings

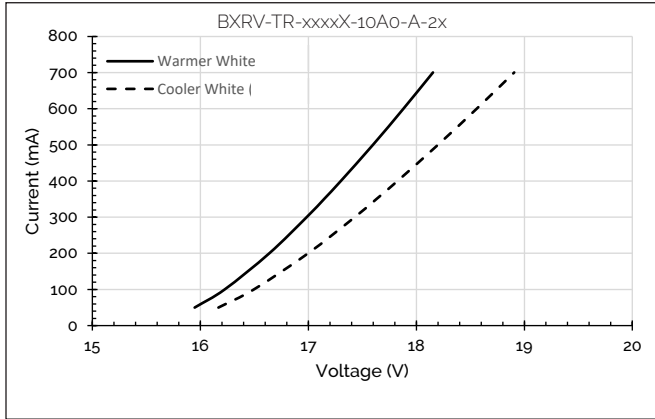
Parameter	Maximum Rating			
LED Junction Temperature ( $T_j$ )	125°C			
Storage Temperature	-40°C to +105°C			
Operating Case Temperature <sup>1</sup> ( $T_c$ )	105°C			
Soldering Temperature <sup>2</sup>	300°C or lower for a maximum of 6 seconds			
	BXRV-TR-xxxxX-10A0-A-2x		BXRV-TR-xxxxX-10A0-B-2x	
	Channel 1	Channel 2	Channel 1	Channel 2
	2700K, 2200K, 1800K	5000K, 6500K, 4000K	2700K, 2200K, 1800K	5000K, 6500K, 3000K, 4000K
Maximum Combined Drive Current <sup>4</sup>	700mA	700mA	480mA	480mA
Maximum Peak Pulsed Drive Current <sup>5</sup>	960mA	720mA	500mA	500mA
Maximum Total Power	13.0W		18.0W	

Notes for Table 6:

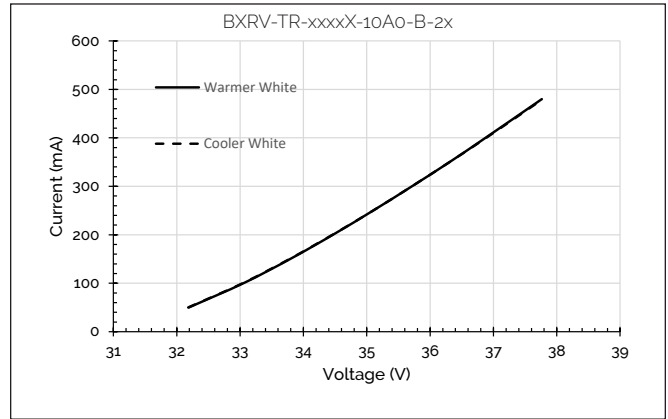
- For IEC 62717 requirement, please contact Bridgelux Sales Support.
- See Bridgelux Application Note AN 92 for more information.
- Lumen maintenance and lifetime predictions are valid for drive current and case temperature conditions used for LM-80 testing as included in the applicable LM-80 test report. Contact your Bridgelux sales representatives for the LM-80 report.
- The Maximum Combined Drive Current is defined as the sum of the drive currents in both channels.  
Example for BXRV-TR-18xxG-10A0-B-23: If 480mA is applied to one channel, no current may be applied to the other channel. If 350mA is applied to one channel, then a maximum of 130mA can be applied to the other channel.  
Example for BXRV-TR-27xxG-10A0-A-2x: If 700mA is applied to one channel, no current may be applied to the other channel. If 350mA is applied to one channel, then a maximum of 350mA can be applied to the other channel.
- Bridgelux recommends a maximum duty cycle of 10% and pulse width of 20ms when operating LED arrays at the maximum peak pulsed current specified.

# Performance Curves

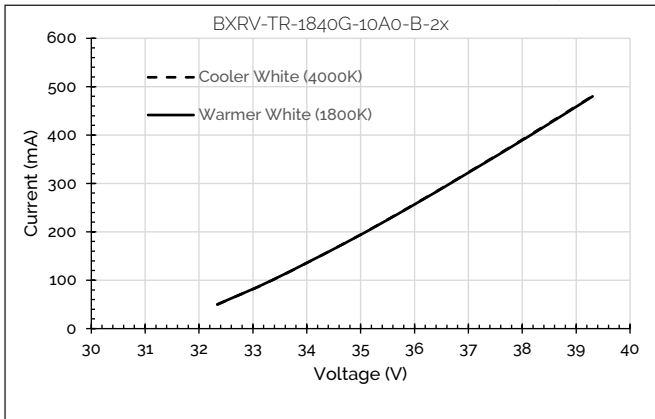
**Figure 6: Forward Voltage vs. Forward Current,  $T_c=25^\circ\text{C}$**



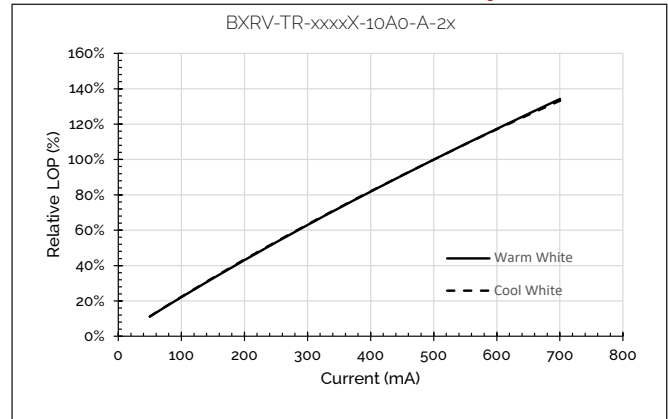
**Figure 7: Forward Voltage vs. Forward Current,  $T_c=25^\circ\text{C}$**



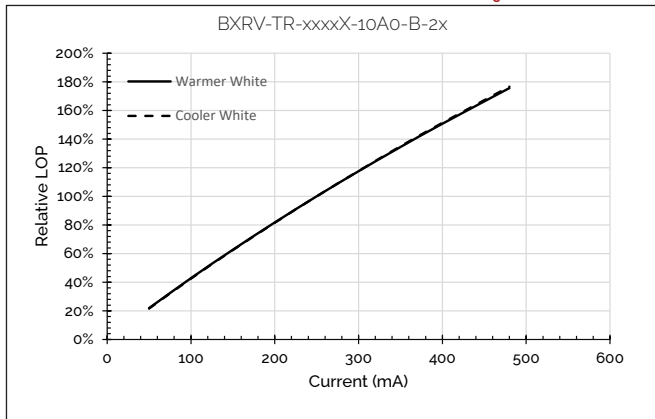
**Figure 8: Forward Voltage vs. Forward Current,  $T_c=25^\circ\text{C}$**



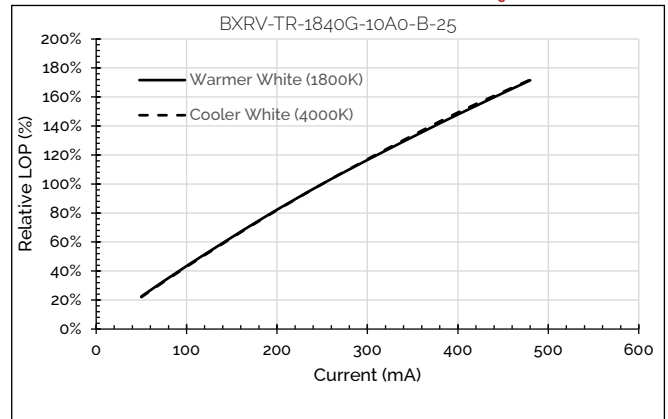
**Figure 9: Relative Flux vs. Drive Current,  $T_c=25^\circ\text{C}$**



**Figure 10: Relative Flux vs. Drive Current,  $T_c=25^\circ\text{C}$**

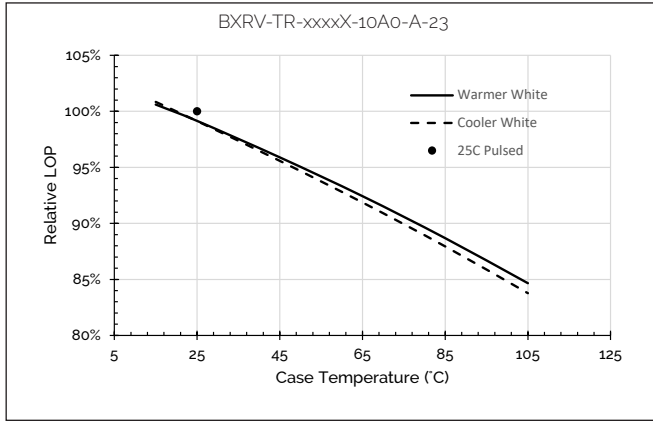


**Figure 11: Relative Flux vs. Drive Current,  $T_c=25^\circ\text{C}$**

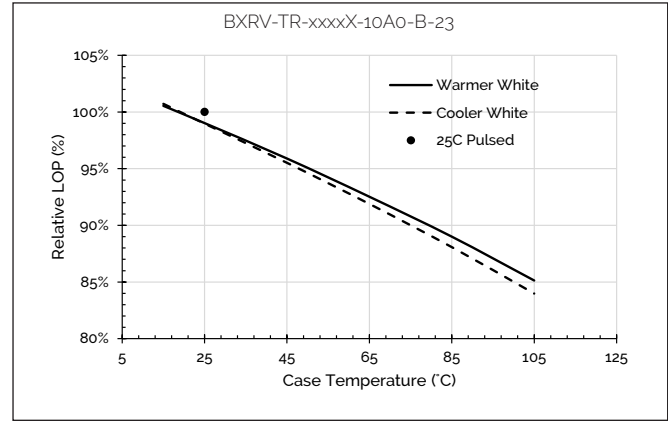


# Performance Curves

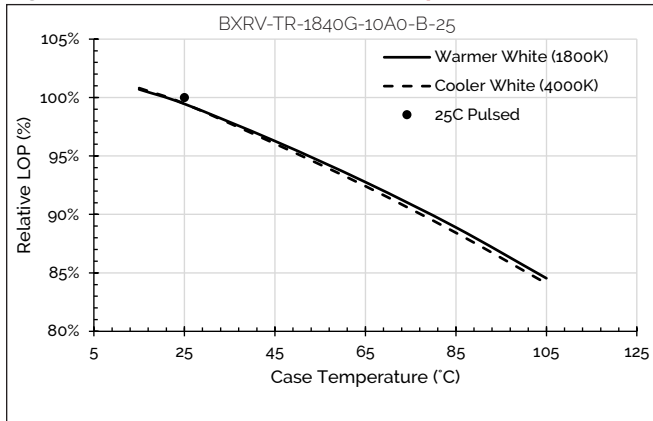
**Figure 12: Relative Flux vs. Case Temperature**



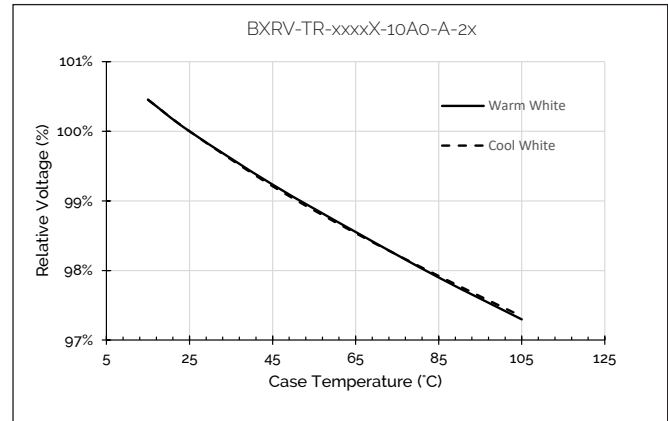
**Figure 13: Relative Flux vs. Case Temperature**



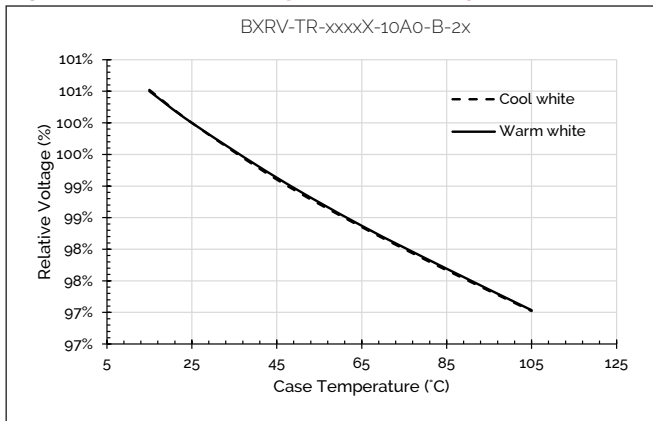
**Figure 14: Relative Flux vs. Case Temperature**



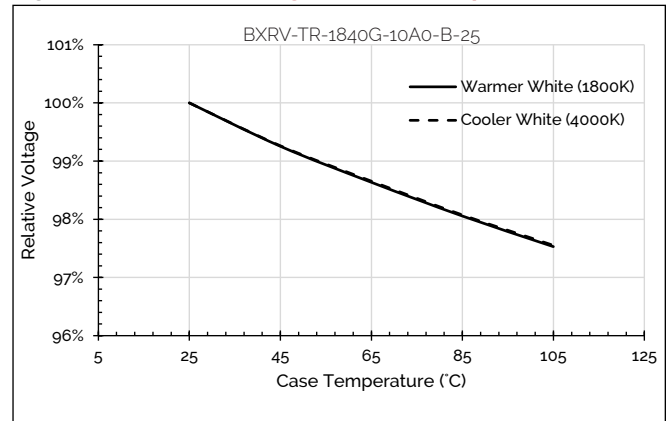
**Figure 15: Relative Voltage vs. Case Temperature**



**Figure 16: Relative Voltage vs. Case Temperature**

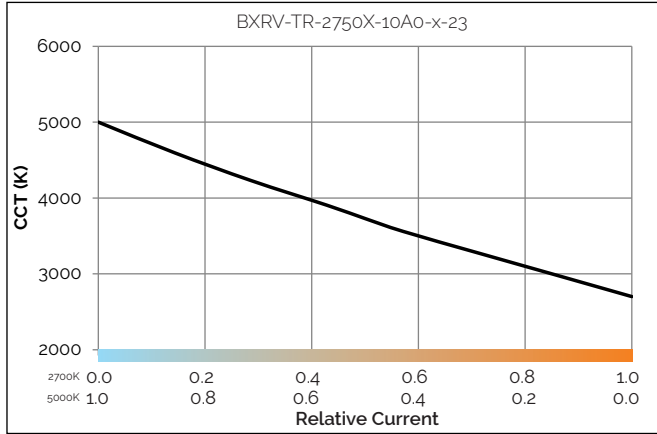


**Figure 17: Relative Voltage vs. Case Temperature**

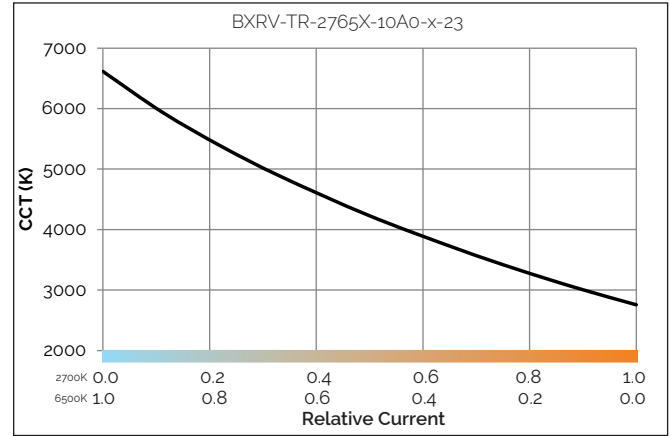


# Performance Curves

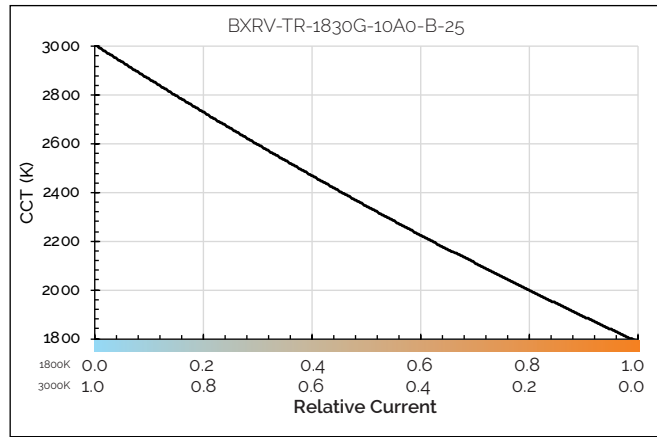
**Figure 18: CCT vs. Relative Current, Tc=85C**



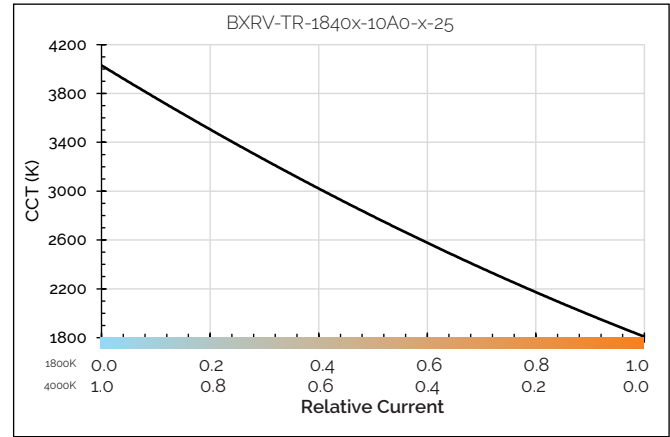
**Figure 19: CCT vs. Relative Current, Tc=85C**



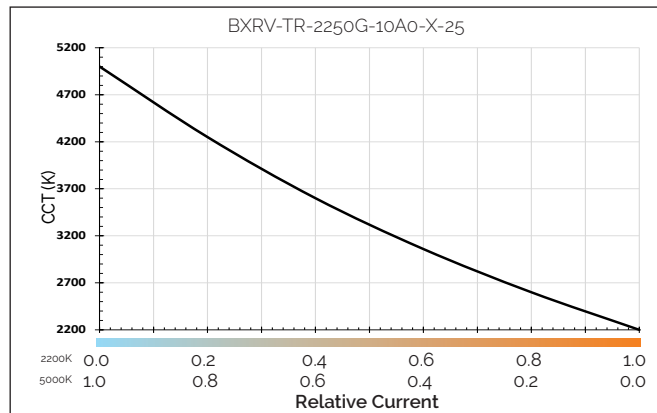
**Figure 20: CCT vs. Relative Current, Tc=85C**



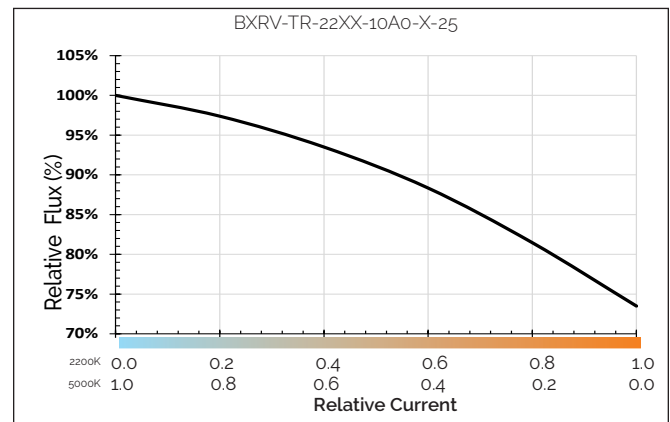
**Figure 21: CCT vs. Relative Current, Tc=85C**



**Figure 22: CCT vs. Relative Current, Tc=85C**

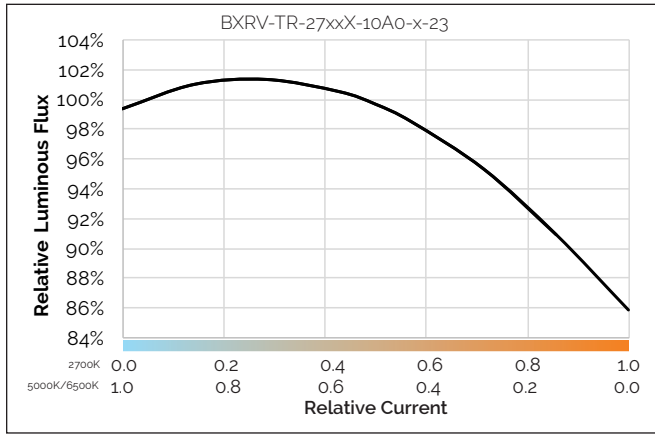


**Figure 23: Relative Flux vs. Relative Current**

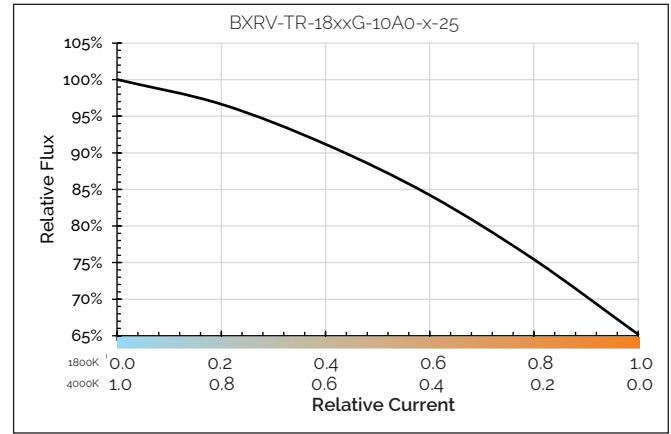


# Performance Curves

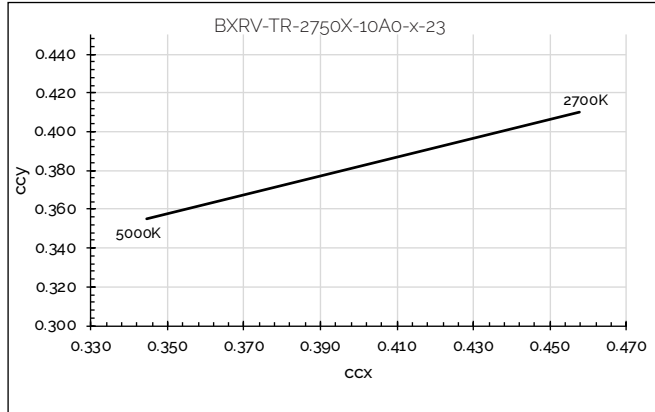
**Figure 24: Relative Flux vs. Relative Current**



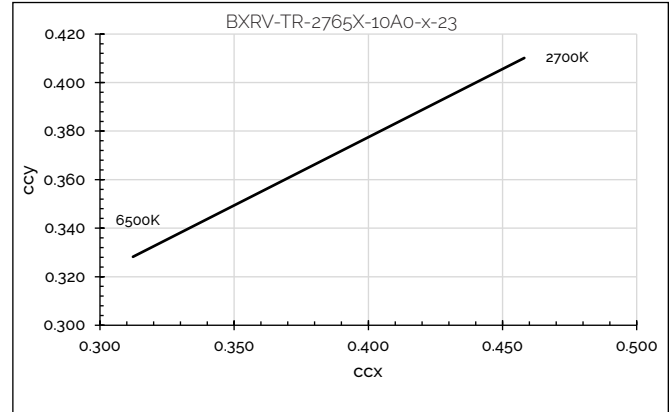
**Figure 25: Relative Flux vs. Relative Current**



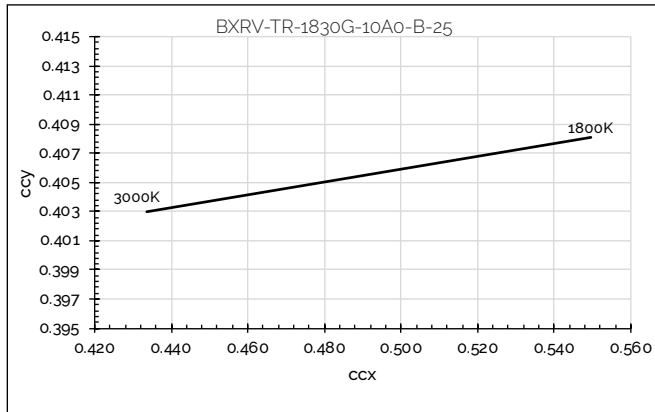
**Figure 26: CCT Tuning Range, Tc=85C**



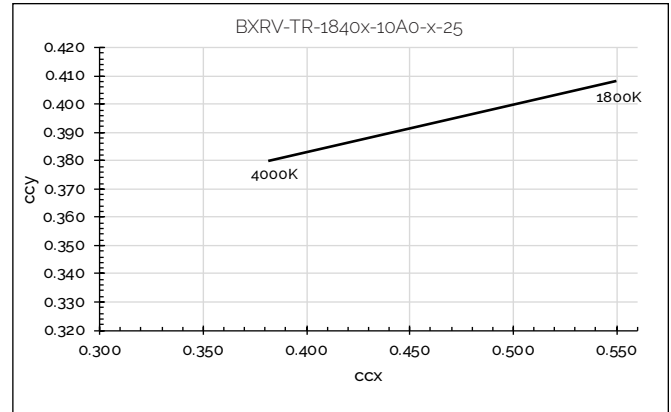
**Figure 27: CCT Tuning Range, Tc=85C**



**Figure 28: CCT Tuning Range, Tc=85C**

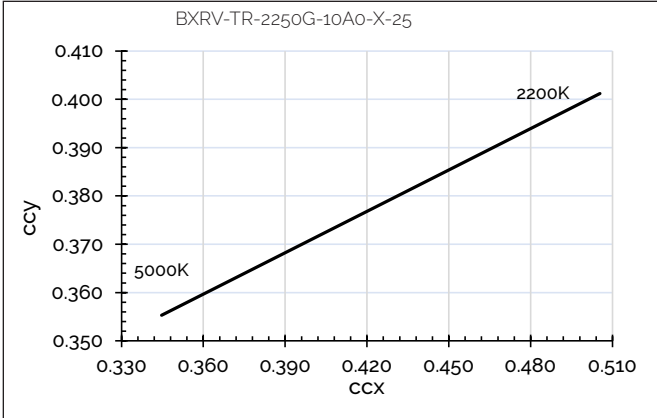


**Figure 29: CCT Tuning Range, Tc=85C**



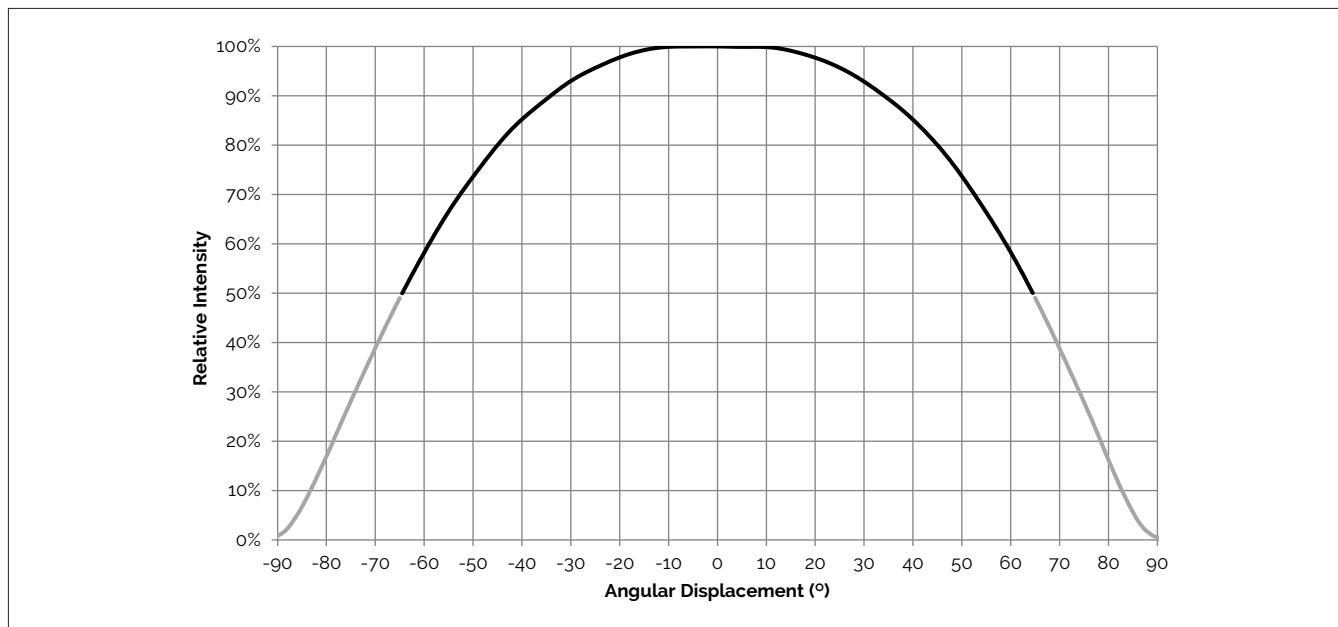
# Performance Curves

Figure 30: CCT Tuning Range, Tc=85C



# Typical Radiation Pattern

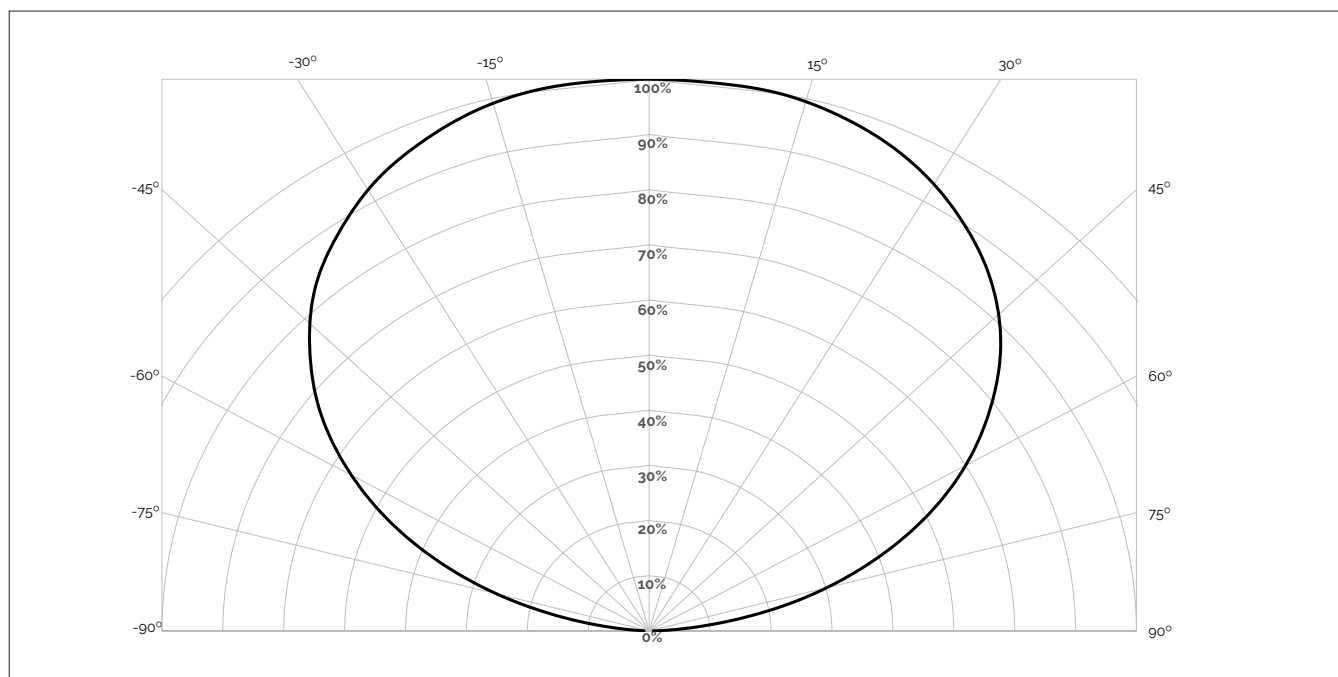
**Figure 31: Typical Spatial Radiation Pattern**



Notes for Figure 28:

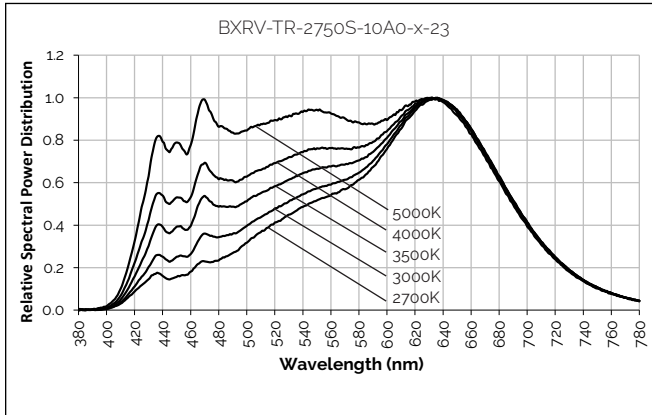
1. Typical viewing angle is 130°.
2. The viewing angle is defined as the off axis angle from the centerline where  $I_v$  is  $\frac{1}{2}$  of the peak value.

**Figure 32: Typical Polar Radiation Pattern**



# Typical Color Spectrum

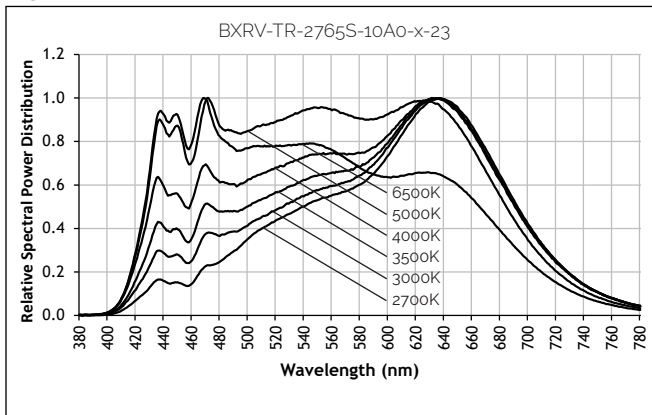
**Figure 33: 2700K - 5000K with Thrive**



Note for Figure 33:

1. Color spectra measured at nominal current and  $T_c = 85^\circ\text{C}$ .

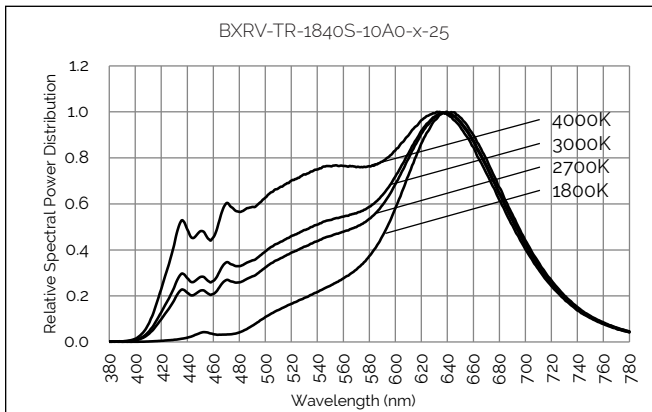
**Figure 34: 2700K - 6500K with Thrive**



Note for Figure 34

1. Color spectra measured at nominal current and  $T_c = 85^\circ\text{C}$ .

**Figure 35: 1800K - 4000K with Thrive**



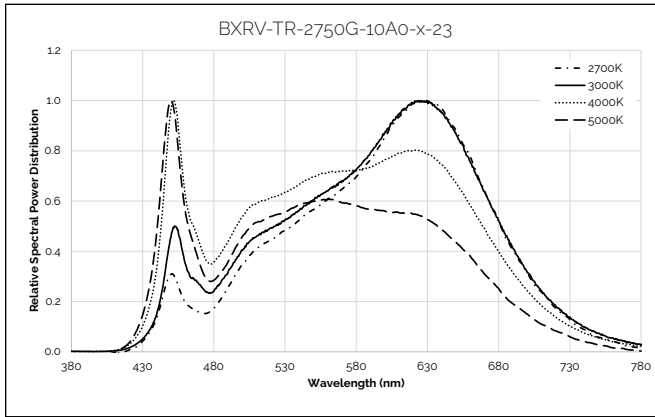
Note for Figure 35:

1. Color spectra measured at nominal current and  $T_c = 25^\circ\text{C}$ .



# Typical Color Spectrum

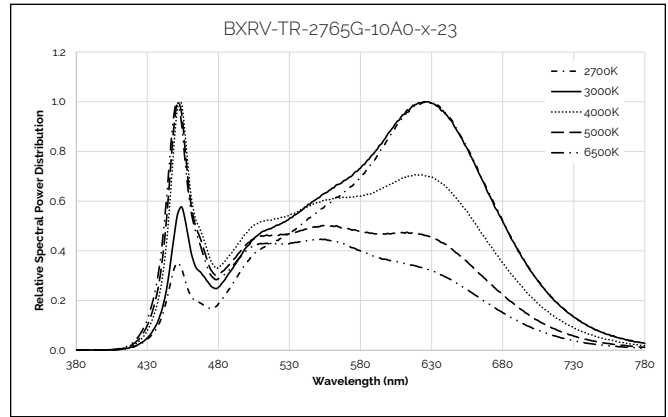
**Figure 36: 2700K - 5000K with 90 CRI**



Note for Figure 36:

1. Color spectra measured at nominal current and  $T_c = 25^\circ\text{C}$ .

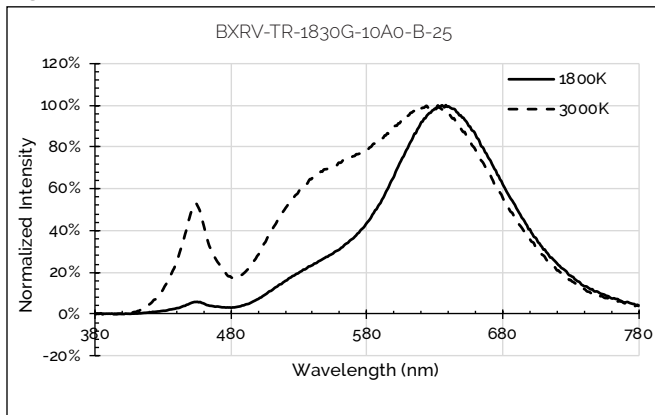
**Figure 37: 2700K - 6500K with 90 CRI**



Note for Figure 37:

1. Color spectra measured at nominal current and  $T_c = 25^\circ\text{C}$ .

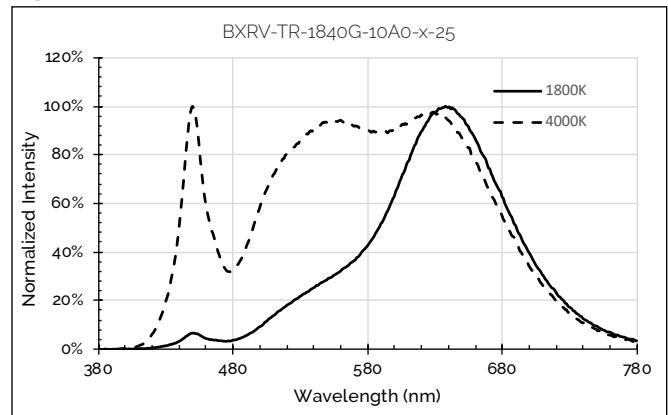
**Figure 38: 1800K - 3000K with 90 CRI**



Note for Figure 38:

1. Color spectra measured at nominal current and  $T_c = 25^\circ\text{C}$ .

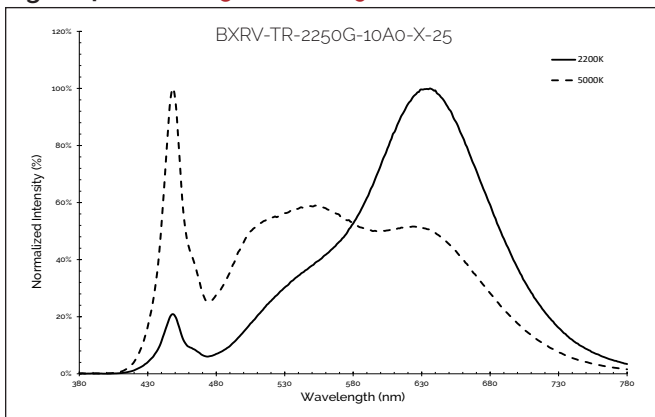
**Figure 39: 1800K - 4000K with 90 CRI**



Note for Figure 39:

1. Color spectra measured at nominal current and  $T_c = 25^\circ\text{C}$ .

**Figure 40: 2200K - 5000K with 90 CRI**



Note for Figure 40:

1. Color spectra measured at nominal current and  $T_c = 25^\circ\text{C}$ .

# Mechanical Dimensions

Figure 41: Drawing for Vesta Series Tunable White Gen2 9mm, 36V Array

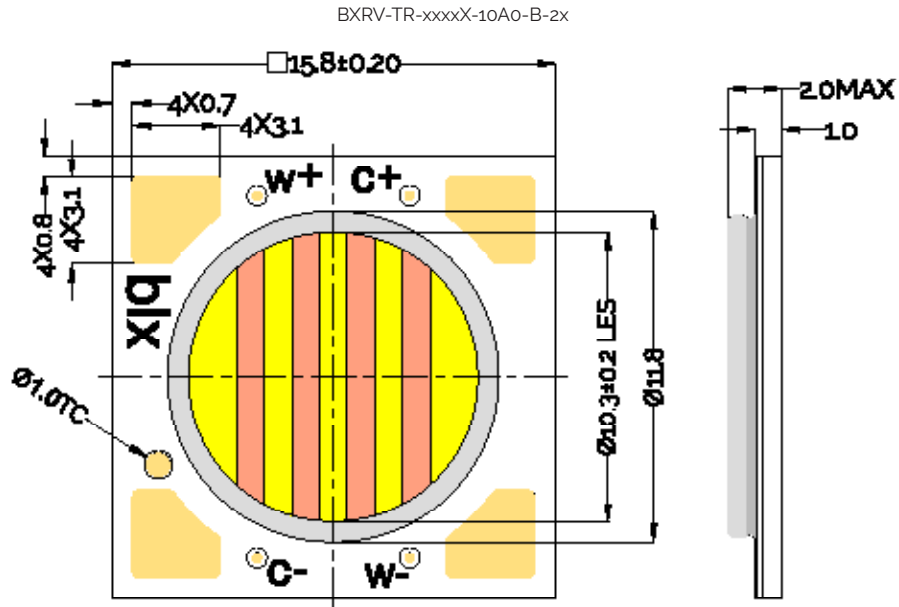
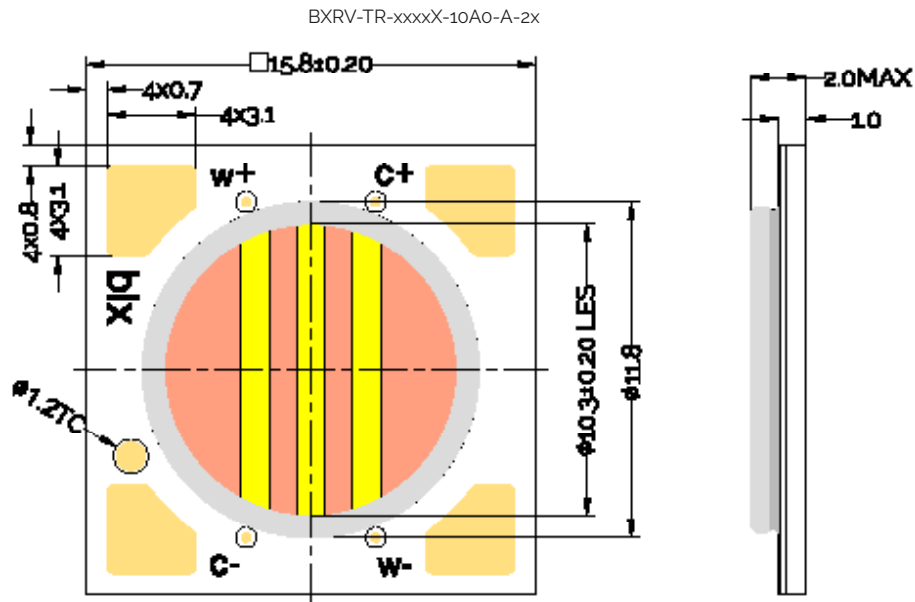


Figure 42: Drawing for Vesta Series Tunable White Gen2 9mm, 18V Array

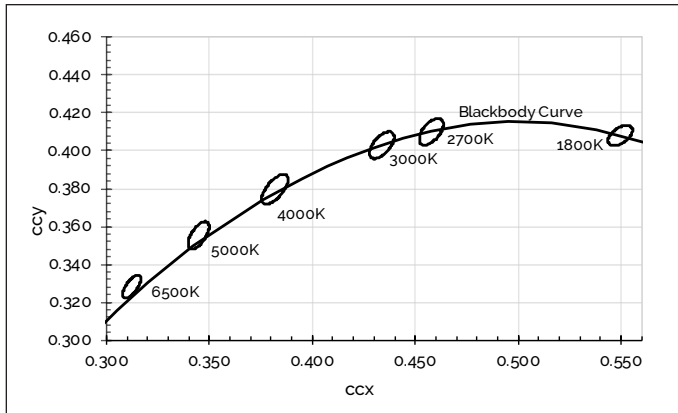


Notes for Figure 41 and 42:

1. The Vesta Series Tunable White Gen 2 9mm 18V (BXRV-TR-xxxxX-10A0-A-2x) and 36V (BXRV-TR-xxxxX-10A0-B-2x) versions have the same mechanical dimensions. The Warm White and Cool White color patterns and the solder pad label positions are different between the two versions.
2. Solder pads are labeled "+" to denote positive polarity and "-" to denote negative polarity. Solder pads have a gold surface finish.
3. Drawings are not to scale.
4. Drawing dimensions are in millimeters.
5. Unless otherwise specified, tolerances are  $\pm 0.10\text{mm}$ .
6. The optical center of the LED array is nominally defined by the mechanical center of the array.
7. Bridgelux maintains a flatness of 0.1 mm across the mounting surface of the array. Refer to Application Notes for product handling, mounting and heat sink recommendations.

# Color Binning Information

**Figure 43: Graph of Bins in xy Color Space, Tc=85C**



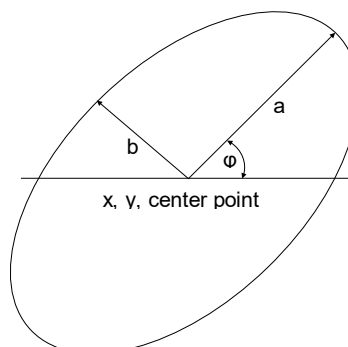
**Table 7: McAdam ellipse CCT color bin definitions for product operating at T<sub>c</sub> = 85°C**

CCT	Center Point	Bin Size	Axis a	Axis b	Rotation Angle
2700K	x=0.4578 y= 0.4101	3 SDCM	0.00810	0.00420	53.70°
5000K	x=0.3447 y=0.3553	3 SDCM	0.00822	0.00354	59.62°
6500K	x=0.3123 y=0.3282	3 SDCM	0.00690	0.00285	58.57°
1800K	x=0.5496 y=0.4081	5SDCM	0.01164	0.00655	40.00°
2200K	x=0.5054 y=0.4012	5SDCM	0.0125	0.007	49.64°
3000K	x=0.4338 y=0.4030	3SDCM	0.00834	0.00408	53.22°
4000K	x=0.3818 y=0.3797	3SDCM	0.00939	0.00402	53.72°

Notes for Table 7:

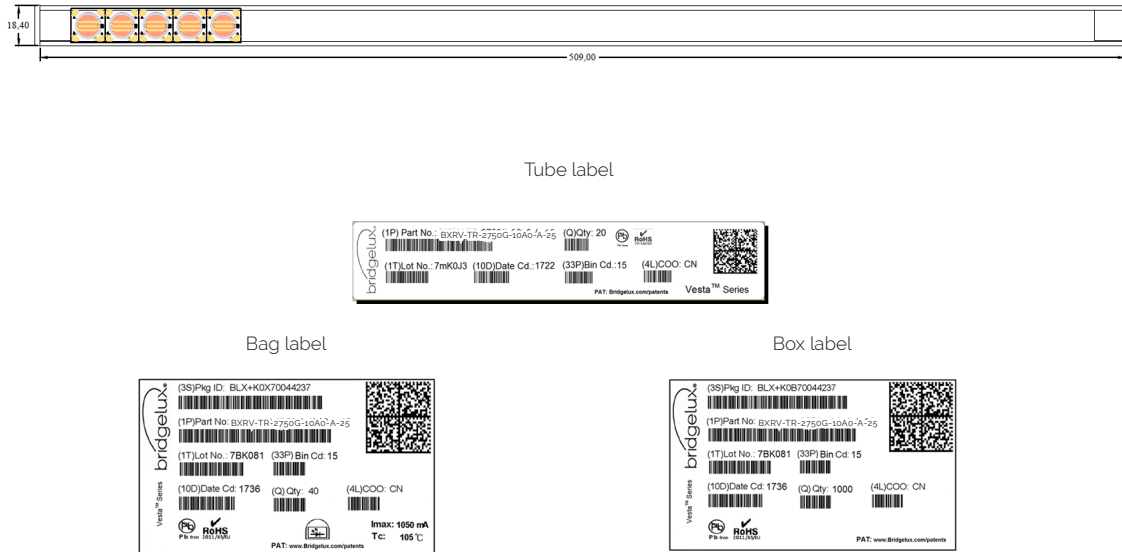
1. The x,y center points are the center points of the respective ANSI bins in the CIE 1931 xy Color Space
2. Products are binned at T<sub>c</sub>=85°C
3. Bridgelux maintains a tolerance of +/-0.007 on x and y color coordinates in the CIE 1931 Color Space

**Figure 44: Definition of the McAdam ellipse**



# Packaging and Labeling

**Figure 45: Vesta Series Tunable White 9mm Packaging and Labeling**



**Notes for Figure 45**

1. Each tube holds 30 Vesta Series Tunable White 9mm arrays.
2. Four tubes are sealed in an anti-static bag. Up to five such bags are placed in a box and shipped. Depending on quantities ordered, a bigger shipping box, containing four boxes will be used to ship products.
3. Each bag and box is to be labeled as shown above.
4. Dimensions for each tube are 509.0 mm (L) x 18.4 mm (W) x 9.5 mm (H). Dimensions for the anti-static bag are 100.0 mm (W) x 625.0 mm (L) x 0.1 mm (T) and that of the inner box are 58.7 mm (L) x 13.3 mm (W) x 7.9 mm (H).

**Figure 46: Product Labeling**

Bridgelux arrays have laser markings on the back side of the substrate to help with product identification. In addition to the product identification markings, Bridgelux arrays also contain markings for internal Bridgelux manufacturing use only. The image below shows which markings are for customer use and which ones are for Bridgelux internal use only. The Bridgelux internal manufacturing markings are subject to change without notice, however these will not impact the form, function or performance of the array.



# Design Resources

## Application Notes

Vesta Series Tunable White arrays are intended for use in dry, indoor applications. Bridgelux has developed a comprehensive set of application notes and design resources to assist customers in successfully designing with the Vesta Series product family of LED array products. For a list of resources under development, visit [www.bridgelux.com](http://www.bridgelux.com).

## Optical Source Models

Optical source models and ray set files are available for all Bridgelux products. For a list of available formats, visit [www.bridgelux.com](http://www.bridgelux.com).

## 3D CAD Models

Three dimensional CAD models depicting the product outline of all Bridgelux Vesta Series LED arrays are available in both IGS and STEP formats. Please contact your Bridgelux sales representative for assistance.

## LM80

Please contact your Bridgelux sales representative for more information.

# Precautions

## CAUTION: CHEMICAL EXPOSURE HAZARD

Exposure to some chemicals commonly used in luminaire manufacturing and assembly can cause damage to the LED array. Please consult Bridgelux Application Notes, ANg2, ANg3 and AN101 for additional information.

## CAUTION: EYE SAFETY

Eye safety classification for the use of Bridgelux Vesta Series is in accordance with IEC/TR62778 specification, 'application of IEC 62471 for the assessment of blue light hazard to light source and luminaires'. Vesta Series Tunable White gmm Gen2 arrays may be classified as Risk Group 2 when operated at or below the maximum drive current. Please use appropriate precautions. It is important that employees working with LEDs are trained to use them safely.

## CAUTION: RISK OF BURN

Do not touch the Vesta Series LED array during operation. Allow the array to cool for a sufficient period of time before handling. The Vesta Series LED array may reach elevated temperatures such that could burn skin when touched.

# CAUTION

## CONTACT WITH LIGHT EMITTING SURFACE (LES)

Avoid any contact with the LES. Do not touch the LES of the LED array or apply stress to the LES (yellow phosphor resin area). Contact may cause damage to the LED array.

Optics and reflectors must not be mounted in contact with the LES (yellow phosphor resin area). Optical devices may be mounted on the top surface of the Vesta Series LED array. Use the mechanical features of the LED array housing, edges and/or mounting holes to locate and secure optical devices as needed.

# Disclaimers

## STANDARD TEST CONDITIONS

Unless otherwise stated, array testing is performed at the nominal drive current.

## MINOR PRODUCT CHANGE POLICY

The rigorous qualification testing on products offered by Bridgelux provides performance assurance. Slight cosmetic changes that do not affect form, fit, or function may occur as Bridgelux continues product optimization.

# About Bridgelux: Bridging Light and Life™

At Bridgelux, we help companies, industries and people experience the power and possibility of light. Since 2002, we've designed LED solutions that are high performing, energy efficient, cost effective and easy to integrate. Our focus is on light's impact on human behavior, delivering products that create better environments, experiences and returns—both experiential and financial. And our patented technology drives new platforms for commercial and industrial luminaires.

For more information about the company, please visit

[bridgelux.com](http://bridgelux.com)

[twitter.com/Bridgelux](https://twitter.com/Bridgelux)

[facebook.com/Bridgelux](https://facebook.com/Bridgelux)

[youtube.com/user/Bridgelux](https://youtube.com/user/Bridgelux)

[linkedin.com/company/bridgelux](https://linkedin.com/company/bridgelux)

WeChat ID: BridgeluxInChina



46410 Fremont Blvd  
Fremont, CA 94538 USA  
Tel (925) 583-8400  
[www.bridgelux.com](http://www.bridgelux.com)

© 2023 Bridgelux, Inc. All rights reserved 2022. Product specifications are subject to change without notice. Bridgelux, the Bridgelux stylized logo design and Vesta are registered trademarks of Bridgelux, Inc. All other trademarks are the property of their respective owners.

**Bridgelux Vesta Series Tunable White Gen 2 9mm Array Product Data Sheet DS350 Rev. L (09/2023)**