



Bridgelux® Gen. 7 V4 HD LED Array

Product Data Sheet DS400



Introduction

V Series HD



V Series™ HD LED array product, an ultra-high lumen density COB product line, is designed for high intensity spotlights used in commercial and retail settings. V Series HD arrays offer industry leading color over angle uniformity, and replace ceramic metal halide lamps by providing equal or greater center beam candle power at lower power and at greater lifetimes. Their tight beam control and exceptional quality of light is well suited for demanding directional spot applications.

The V4 HD LED array is available in a variety of CCT and CRI combinations providing substantial design flexibility and energy efficiencies.

Lighting system designs incorporating these LED arrays deliver increased system level efficacy and longer service life. Typical applications include, but are not limited to, commercial and residential down lights, accent, spot and track lights.

Bridgelux Décor Series™ is our state of the art color line designed specifically for premium applications, producing unmatched LED light quality with brilliant color-rendering options and offer pleasing and inspiring lighting palettes. Bridgelux Décor Series color points are available on Vero® SE Series, Vero® Series, V Series™ and V Series™ HD.

Décor Series Class A is based on human response testing, providing color points with a combined GAI and CRI metric.

Décor Series™ Ultra products provide a high CRI of 97 and a minimum R9 value of 91, which emphasizes the reds and color tones to which the human eye is most receptive - perfect for the most luxurious retail shops and world renowned museums. Décor Series Ultra is designed as a replacement for halogen.

Décor Series™ Showcase is the optimal solution for replacing ceramic metal halide lamps, incorporating the same pure white light with enhanced spectrum coverage and higher efficacy.

Features

- Efficacy of 120 lm/W typical
- Compact high flux density light source
- Uniform high quality illumination
- Minimum 80, 90 and 95 CRI options
- Streamlined thermal path
- ENERGY STAR® / ANSI compliant color binning structure with 3 SDCM options
- More energy efficient than incandescent, halogen and fluorescent lamps
- Low voltage DC operation
- Instant light with unlimited dimming
- V_f bin code backside marking

Benefits

- Enhanced optical control
- Clean white light without pixelation
- High quality true color reproduction
- Significantly reduced thermal resistance and increased operating temperatures
- Uniform consistent white light
- Lower operating costs
- Easy to use with daylight and motion detectors to enable increased energy savings
- Reduced maintenance costs
- Environmentally friendly, no disposal issue



Contents

Product Feature Map	2
Product Nomenclature	2
Product Selection Guide	3
European Product Registry for Energy Labeling	5
Performance at Commonly Used Drive Currents	6
Electrical Characteristics	8
Eye Safety	9
Absolute Maximum Ratings	10
Performance Curves	11
Typical Radiation Pattern	13
Typical Color Spectrum	14
Mechanical Dimensions	15
Color Binning Information	16
Packaging and Labeling	17
Design Resources	19
Precautions	19
Disclaimers	19
About Bridgelux	20

Product Feature Map

Bridgelux arrays are fully engineered devices that provide consistent thermal and optical performance on an engineered mechanical platform. The V Series HD arrays are the most compact chip-on-board devices across all of

Bridgelux's LED Array products. The arrays incorporate several features to simplify design integration and assembly. Please visit www.bridgelux.com for more information on the V Series HD family of products.

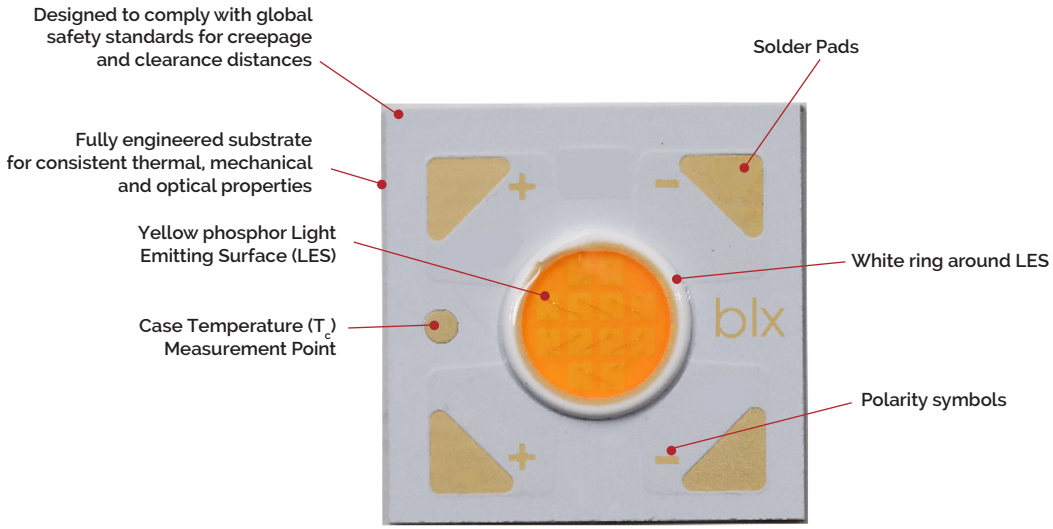

Note: Part number and lot codes are scribed on back of array

Product Nomenclature

The part number designation for Bridgelux V Series HD LED arrays is explained as follows:

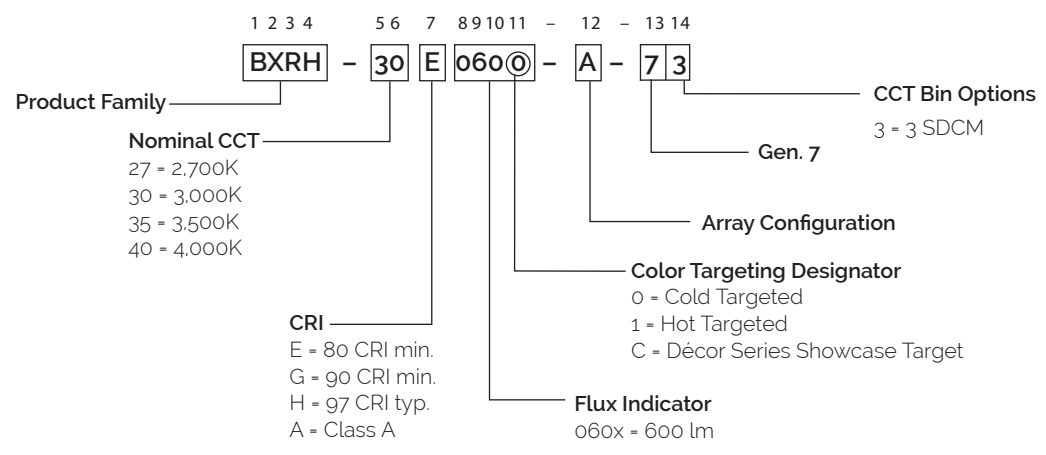

Product Selection Guide

The following product configurations are available:

Table 1: Selection Guide, Pulsed Measurement Data ($T_j = T_c = 25^\circ\text{C}$)

Part Number	Nominal CCT ¹ (K)	CRI ²	Nominal Drive Current ³ (mA)	Typical Pulsed Flux ^{4,5,6} $T_c = 25^\circ\text{C}$ (lm)	Minimum Pulsed Flux ^{6,7} $T_c = 25^\circ\text{C}$ (lm)	Typical V_f (V)	Typical Power (W)	Typical Efficacy (lm/W)
BXRH-27E0600-A-73	2700	80	175	727	625	36.4	6.4	114
BXRH-27G0600-A-73	2700	90	175	604	520	36.4	6.4	95
BXRH-27H0600-A-73	2700	97	175	536	461	36.4	6.4	84
BXRH-30E0600-A-73	3000	80	175	765	658	36.4	6.4	120
BXRH-30G0600-A-73	3000	90	175	643	553	36.4	6.4	101
BXRH-30G060C-A-73	3000	90	175	589	507	36.4	6.4	92
BXRH-30H0600-A-73	3000	97	175	566	487	36.4	6.4	89
BXRH-35A0601-A-73 ^{8,9}	3500	93	175	643	553	36.4	6.4	101
BXRH-35G0600-A-73	3500	90	175	658	566	36.4	6.4	103
BXRH-40E0600-A-73	4000	80	175	796	684	36.4	6.4	125
BXRH-40G0600-A-73	4000	90	175	673	579	36.4	6.4	106
BXRH-50E0600-A-73	5000	80	175	796	685	36.4	6.4	125
BXRH-50G0600-A-73	5000	90	175	688	592	36.4	6.4	108

Notes for Table 1:

- Nominal CCT as defined by ANSI C78.377-2011.
- CRI values are typical for Decor Series Ultra and Decor Series Class A products. CRI values are minimums for all other products. Minimum Rg value for 80 CRI products is 0, the minimum Rg values for 90 CRI products is 50, the minimum Rg values for 97 CRI products is 91. Bridgelux maintains a ± 3 tolerance on CRI and Rg values.
- Drive current is referred to as nominal drive current.
- Products tested under pulsed condition (10ms pulse width) at nominal test current where T_j (junction temperature) - T_c (case temperature) = 25°C .
- Typical performance values are provided as a reference only and are not a guarantee of performance.
- Bridgelux maintains a $\pm 7\%$ tolerance on flux measurements.
- Minimum flux values at the nominal test current are guaranteed by 100% test.
- Nominal CCT is defined by the Lighting Research Center's Class A definition. The center of the Class A color bin is on the corresponding isothermal line.

Product Selection Guide

Table 2: Selection Guide, Stabilized DC Performance ($T_c = 85^\circ\text{C}$)^{4,5}

Part Number	Nominal CCT ¹ (K)	CRI ²	Nominal Drive Current ³ (mA)	Typical DC Flux ^{4,5} $T_c = 85^\circ\text{C}$ (lm)	Minimum DC Flux ⁶ $T_c = 85^\circ\text{C}$ (lm)	Typical V_f (V)	Typical Power (W)	Typical Efficacy (lm/W)
BXRH-27E0600-A-73	2700	80	175	640	550	35.4	6.2	103
BXRH-27G0600-A-73	2700	90	175	532	457	35.4	6.2	86
BXRH-27H0600-A-73	2700	97	175	471	405	35.4	6.2	76
BXRH-30E0600-A-73	3000	80	175	673	579	35.4	6.2	109
BXRH-30G0600-A-73	3000	90	175	565	486	35.4	6.2	91
BXRH-30G060C-A-73	3000	90	175	518	446	35.4	6.2	84
BXRH-30H0600-A-73	3000	97	175	498	428	35.4	6.2	80
BXRH-35A0601-A-73 ^{7,8}	3500	93	175	565	486	35.4	6.2	91
BXRH-35G0600-A-73	3500	90	175	579	498	35.4	6.2	93
BXRH-40E0600-A-73	4000	80	175	700	602	35.4	6.2	113
BXRH-40G0600-A-73	4000	90	175	592	509	35.4	6.2	96
BXRH-50E0600-A-73	5000	80	175	701	603	35.4	6.2	113
BXRH-50G0600-A-73	5000	90	175	606	521	35.4	6.2	98

Notes for Table 2:

- Nominal CCT as defined by ANSI C78.377-2011.
- All CRI values are measured at $T_j = T_c = 25^\circ\text{C}$. CRI values are typical for Decor Series Ultra and Decor Series Class A products. CRI values are minimums for all other products. Minimum Rg value for 80 CRI products is 0, the minimum Rg values for 90 CRI products is 50, the minimum Rg values for 97 CRI products is 91. Bridgelux maintains a ± 3 tolerance on CRI and Rg values.
- Drive current is referred to as nominal drive current.
- Typical stabilized DC performance values are provided as reference only and are not a guarantee of performance.
- Typical performance is estimated based on operation under DC (direct current) with LED array mounted onto a heat sink with thermal interface material and the case temperature maintained at 85°C . Based on Bridgelux test setup, values may vary depending on the thermal design of the luminaire and/or the exposed environment to which the product is subjected.
- Minimum flux values at elevated temperatures are provided for reference only and are not guaranteed by 100% production testing. Based on Bridgelux test setup, values may vary depending on the thermal design of the luminaire and/or the exposed environment to which the product is subjected.
- Nominal CCT is defined by the Lighting Research Center's Class A definition. The center of the Class A color bin is on the corresponding isothermal line.
- GAI value is 80. To help ensure optimal fixture level performance, GAI is measured at the fixture level, on axis, at a case temperature of 70°C . GAI may vary depending on fixture design and performance.

European Product Registry for Energy Labeling

The European Product Registry for Energy Labeling (EPREL) is defined in the EU Regulation 2017/1369 to provide important energy efficiency information to consumers. Together with Energy Labeling Regulation ELR (EU) 2019/2015 which was amended by regulation (EU) 2021/340 for energy labelling of light sources, manufacturers are required to declare an energy class based on key technical specifications from each of their product and register it in an open data base managed by EPREL. It is now a legal requirement for a vendor of light sources to upload information about their products into the EPREL database before placing these products on the market in the EU.

Table 3 below provides a list of part numbers that are in compliance with ELR and are currently listed in the EPREL database.

At Bridgelux, we are fully committed to supplying products that are compliant with pertinent laws, rules, and obligation imposed by relevant government bodies including the European Energy Labeling regulation. Customers can use these products with full confidence for any projects that fall under the ELR.

Table 3: Part numbers registered in European Product Registry for Energy Labeling

PART NUMBER ¹	CCT (K)	CRI	Current ² (mA)	Vf (V)	Useful flux ³ (Φ_{use}) at 85C (lm)	Power (W)	Efficacy (lm/W)	Energy efficiency class ⁴	Registration No	URL to Product Information Sheet in EPREL Database
BXRH-27E0600-A-73	2700	80	210	37.9	779	8.0	98	F	875775	https://eprelec.europa.eu/qr/875775
BXRH-27G0600-A-73	2700	90	170	36.4	539	6.2	87	G	875797	https://eprelec.europa.eu/qr/875797
BXRH-27H0600-A-73	2700	95	150	35.4	424	5.3	80	G	875831	https://eprelec.europa.eu/qr/875831
BXRH-30E0600-A-73	3000	80	220	38.2	852	8.4	101	F	875861	https://eprelec.europa.eu/qr/875861
BXRH-30G0600-A-73	3000	90	190	37.3	633	7.1	89	G	875887	https://eprelec.europa.eu/qr/875887
BXRH-30G060C-A-73	3000	90	160	38.7	525	6.2	85	G	875893	https://eprelec.europa.eu/qr/875893
BXRH-30H0600-A-73	3000	95	160	38.7	505	6.2	82	G	875940	https://eprelec.europa.eu/qr/875940
BXRH-35A0601-A-73	3500	90	190	37.3	633	7.1	89	G	875967	https://eprelec.europa.eu/qr/875967
BXRH-35G0600-A-73	3500	90	200	37.6	677	7.5	90	G	875998	https://eprelec.europa.eu/qr/875998
BXRH-40E0600-A-73	4000	80	240	36.9	917	8.8	104	F	876040	https://eprelec.europa.eu/qr/876040
BXRH-40G0600-A-73	4000	90	200	39.8	722	8.0	91	G	876062	https://eprelec.europa.eu/qr/876062

Notes for Table 3:

1. All device listed here must be disposed as e-waste upon its end of life according to local country guideline in each country.
2. For information on performance values at alternative drive conditions, please refer to the Product Selection Guide, Absolute Maximum Rating Table and Performance Curves in this data sheet.
3. For a definition of useful luminous flux (Φ_{use}), please see the ELR regulations at <https://tinyurl.com/4b6zvt4m>.
4. EPREL requires an arrow symbol containing the letter of the energy efficiency class to be displayed, on technical promotional material. Refer to this energy efficiency class column for specific energy efficiency class on each part number.

Performance at Commonly Used Drive Currents

V Series HD LED arrays are tested to the specifications shown using the nominal drive currents in Table 1. V Series HD LED arrays may also be driven at other drive currents dependent on specific application design requirements. The performance at any drive current can be derived from the current vs. voltage characteristics shown in Figure 1 and the flux vs. current characteristics shown in Figure 2. The performance at commonly used drive currents is summarized in Table 4.

Table 4: Product Performance at Commonly Used Drive Currents

Part Number	CRI	Drive Current ¹ (mA)	Typical V _f T _c = 25°C (V)	Typical Power T _c = 25°C (W)	Typical Flux ² T _c = 25°C (lm)	Typical DC Flux ³ T _c = 85°C (lm)	Typical Efficacy T _c = 25°C (lm/W)
BXRH-27E0600-A-73	80	85	34.1	2.9	380	334	131
		130	35.3	4.6	559	492	122
		175	36.4	6.4	727	640	114
		220	37.3	8.2	883	777	107
		240	37.8	9.1	949	835	105
BXRH-27G0600-A-73	90	85	34.1	2.9	316	278	109
		130	35.3	4.6	465	409	101
		175	36.4	6.4	604	532	95
		220	37.3	8.2	734	646	89
		240	37.8	9.1	789	694	87
BXRH-27H0600-A-73	97 (typical)	85	34.1	2.9	280	246	97
		130	35.3	4.6	412	363	90
		175	36.4	6.4	536	471	84
		220	37.3	8.2	650	572	79
		240	37.8	9.1	699	615	77
BXRH-30E0600-A-73	80	85	34.1	2.9	400	352	138
		130	35.3	4.6	589	518	128
		175	36.4	6.4	765	673	120
		220	37.3	8.2	929	818	113
		240	37.8	9.1	999	879	110
BXRH-30G0600-A-73	90	85	34.1	2.9	336	296	116
		130	35.3	4.6	495	435	108
		175	36.4	6.4	643	565	101
		220	37.3	8.2	781	687	95
		240	37.8	9.1	839	738	93
BXRH-30G060C-A-73	90	85	34.1	2.9	308	271	106
		130	35.3	4.6	453	399	99
		175	36.4	6.4	589	518	93
		220	37.3	8.2	716	630	87
		240	37.8	9.1	769	677	85
BXRH-30H0600-A-73	97 (typical)	85	34.1	2.9	296	260	102
		130	35.3	4.6	436	384	95
		175	36.4	6.4	566	498	89
		220	37.3	8.2	688	605	84
		240	37.8	9.1	739	650	82
BXRH-35A0601-A-73	93 (typical)	85	34.1	2.9	336	296	116
		130	35.3	4.6	495	435	108
		175	36.4	6.4	643	565	101
		220	37.3	8.2	781	687	95
		240	37.8	9.1	839	738	93

Notes for Table 4:

1. Alternate drive currents are provided for reference only and are not a guarantee of performance.
2. Bridgelux maintains a ± 7% tolerance on flux measurements.
3. Typical stabilized DC performance values are provided as reference only and are not a guarantee of performance.

Performance at Commonly Used Drive Currents

Table 4: Product Performance at Commonly Used Drive Currents (Continued)

Part Number	CRI	Drive Current ¹ (mA)	Typical V_f $T_c = 25^\circ\text{C}$ (V)	Typical Power $T_c = 25^\circ\text{C}$ (W)	Typical Flux ² $T_c = 25^\circ\text{C}$ (lm)	Typical DC Flux ³ $T_c = 85^\circ\text{C}$ (lm)	Typical Efficacy $T_c = 25^\circ\text{C}$ (lm/W)
BXRH-35G0600-A-73	90	85	34.1	2.9	344	303	119
		130	35.3	4.6	506	446	110
		175	36.4	6.4	658	579	103
		220	37.3	8.2	799	703	97
		240	37.8	9.1	859	756	95
BXRH-40E0600-A-73	80	85	34.1	2.9	416	366	144
		130	35.3	4.6	612	539	134
		175	36.4	6.4	796	700	125
		220	37.3	8.2	966	850	118
		240	37.8	9.1	1039	914	115
BXRH-40G0600-A-73	90	85	34.1	2.9	352	310	121
		130	35.3	4.6	518	456	113
		175	36.4	6.4	673	592	106
		220	37.3	8.2	818	720	100
		240	37.8	9.1	879	774	97
BXRH-50E0600-A-73	80	85	34.1	2.9	416	366	144
		130	35.3	4.6	613	539	134
		175	36.4	6.4	796	701	125
		220	37.3	8.2	967	852	118
		240	37.8	9.1	1040	915	115
BXRH-50G0600-A-73	90	85	34.1	2.9	360	317	124
		130	35.3	4.6	530	466	115
		175	36.4	6.4	688	606	108
		220	37.3	8.2	836	736	102
		240	37.8	9.1	899	791	99

Notes for Table 4:

1. Alternate drive currents are provided for reference only and are not a guarantee of performance.
2. Bridgelux maintains a $\pm 7\%$ tolerance on flux measurements.
3. Typical stabilized DC performance values are provided as reference only and are not a guarantee of performance.

Electrical Characteristics

Table 5: Electrical Characteristics

Part Number	Drive Current (mA)	Forward Voltage Pulsed, $T_c = 25^\circ\text{C}$ (V) ^{1, 2, 3, 8}			Typical Coefficient of Forward Voltage ⁴ $\Delta V_f / \Delta T_c$ (mV/ $^\circ\text{C}$)	Typical Thermal Resistance Junction to Case ^{5,6} R_{j-c} ($^\circ\text{C}/\text{W}$)	Driver Selection Voltages ⁷ (V)	
		Minimum	Typical	Maximum			V_f Min. Hot $T_c = 105^\circ\text{C}$ (V)	V_f Max. Cold $T_c = -40^\circ\text{C}$ (V)
BXRH-xxx060x-A-73	175	34.1	36.4	39.1	-15.5	0.72	32.9	40.1
	240	35.2	37.8	40.4	-15.5	0.77	34.0	41.4

Notes for Table 5:

- Parts are tested in pulsed conditions. $T_c = 25^\circ\text{C}$. Pulse width is 10ms.
- Voltage minimum and maximum are provided for reference only and are not a guarantee of performance.
- Bridgelux maintains a tester tolerance of $\pm 0.10\text{V}$ on forward voltage measurements.
- Typical coefficient of forward voltage tolerance is $\pm 0.1\text{mV}$ for nominal current.
- Thermal resistance values are based from test data of a 3000K 80 CRI product.
- Thermal resistance value was calculated using total electrical input power; optical power was not subtracted from input power. The thermal interface material used during testing is not included in the thermal resistance value.
- V_f min hot and max cold values are provided as reference only and are not guaranteed by test. These values are provided to aid in driver design and selection over the operating range of the product.
- This product has been designed and manufactured per IEC 62031:2018. This product has passed dielectric withstand voltage testing at 500 V. The working voltage designated for the insulation is 50V d.c. The maximum allowable voltage across the array must be determined in the end product application.

Eye Safety

Table 6: Eye Safety Risk Group (RG) Classifications

Part Number	Drive Current ³ (mA)	CCT ^{1,3}	
		2700K/3000K	4000K ²
BXRH-xxx060x-A-73	175	RG1	RG2
	240	RG1	RG2

Notes for Table 6:

1. Eye safety classification for the use of Bridgelux V Series HD LED arrays is in accordance with specification IEC/TR 62778: Application of IEC 62471 for the assessment of blue light hazard to light sources and luminaires.
2. For products classified as RG2 at 4000K, $E_{thr} = 1760$ lx.
3. Please contact your Bridgelux sales representative for E_{thr} values at specific drive currents and CCTs not listed.

Absolute Maximum Ratings

Table 7: Maximum Ratings

Parameter	Maximum Rating
LED Junction Temperature (T_j)	125°C
Storage Temperature	-40°C to +105°C
Operating Case Temperature ¹ (T_c)	105°C
Soldering Temperature ²	300°C or lower for a maximum of 6 seconds
Maximum Drive Current ³	240mA
Maximum Peak Pulsed Drive Current ⁴	340mA
Maximum Reverse Voltage ⁵	-60V

Notes for Table 7:

1. For IEC 62717 requirement, please consult your Bridgelux sales representative.
2. Refer to Bridgelux Application Note AN101: Handling and Assembly of Bridgelux V Series LED Arrays.
3. Arrays may be driven at higher currents however lumen maintenance may be reduced, and product warranty will be void.
4. Bridgelux recommends a maximum duty cycle of 10% and pulse width of 20 ms when operating LED Arrays at maximum peak pulsed current specified. Maximum peak pulsed currents indicate values where LED Arrays can be driven without catastrophic failures.
5. Light emitting diodes are not designed to be driven in reverse voltage and will not produce light under this condition. Maximum rating provided for reference only.

Performance Curves

Figure 1: Drive Current vs. Voltage²

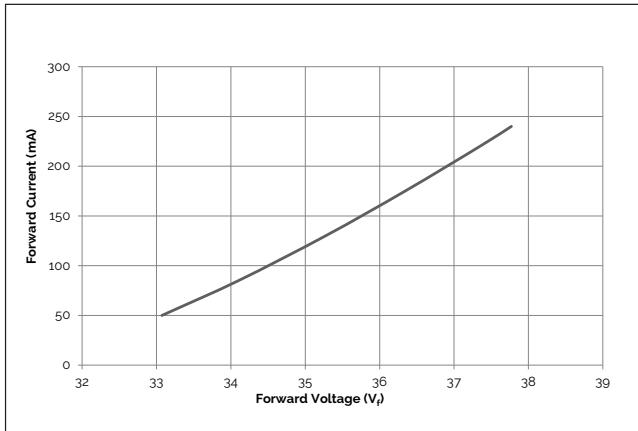

Figure 2: Typical Relative Flux vs. Current^{1,2}

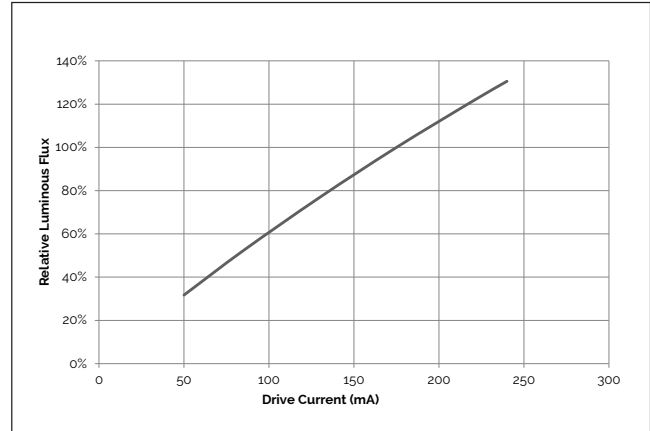

Figure 3: Typical DC Flux vs. Case Temperature³

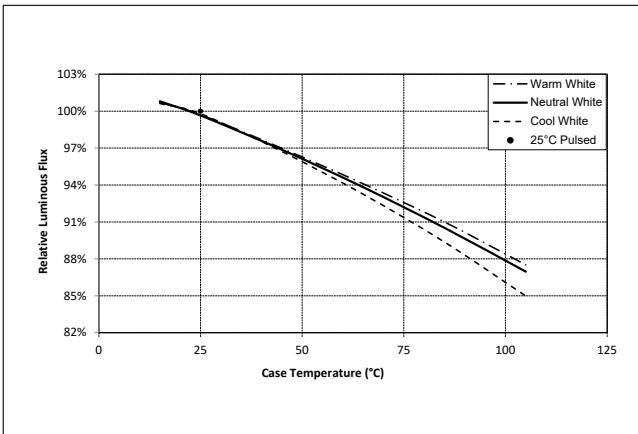

Figure 4: Typical DC ccx Shift vs. Case Temperature⁴

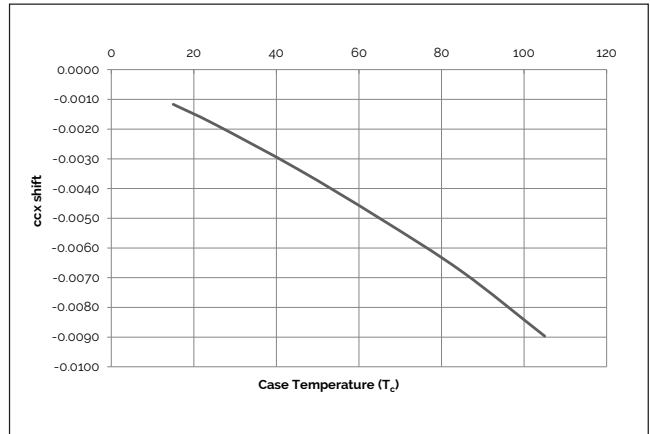
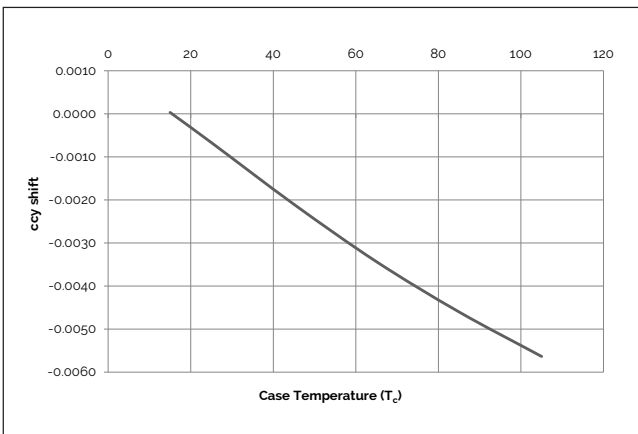

Figure 5: Typical DC ccy Shift vs. Case Temperature⁴



Notes for Figures 1-5:

1. Bridgelux does not recommend driving high power LEDs at low currents. Doing so may produce unpredictable results. Pulse width modulation (PWM) is recommended for dimming effects.
2. Products tested under pulsed condition (10ms pulse width) at nominal test current where T_j (junction temperature) - T_c (case temperature) = 25°C.
3. Characteristics shown for warm white based on 3000K and 80 CRI. Characteristics shown for neutral white based on 4000K and 80 CRI. Characteristics shown for warm white includes Decor Series Class A
4. For other color SKUs, the shift in color will vary. Please contact your Bridgelux Sales Representative for more information.

Performance Curves

Figure 6: 2700K, 97 CRI Color Shift vs. Case Temperature¹

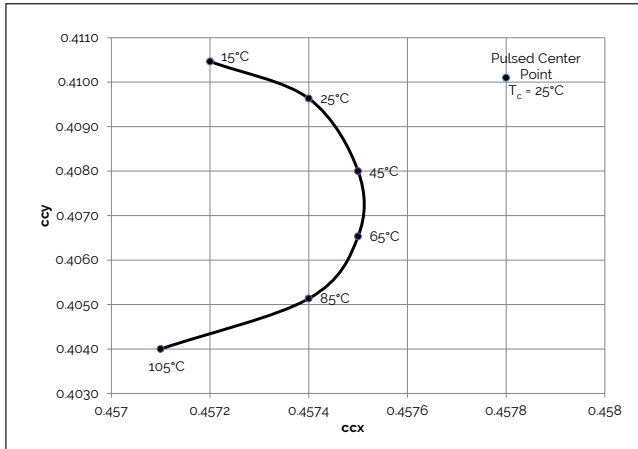

Figure 7: 3000K, 97 CRI Color Shift vs. Case Temperature¹

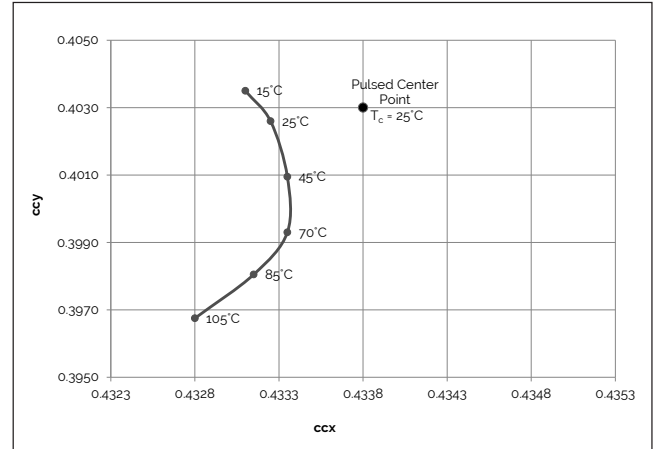

Figure 8: 3500K Class A Color Shift vs. Case Temperature¹

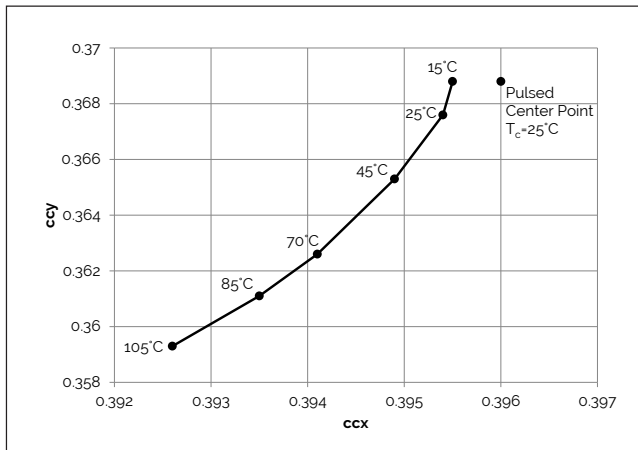
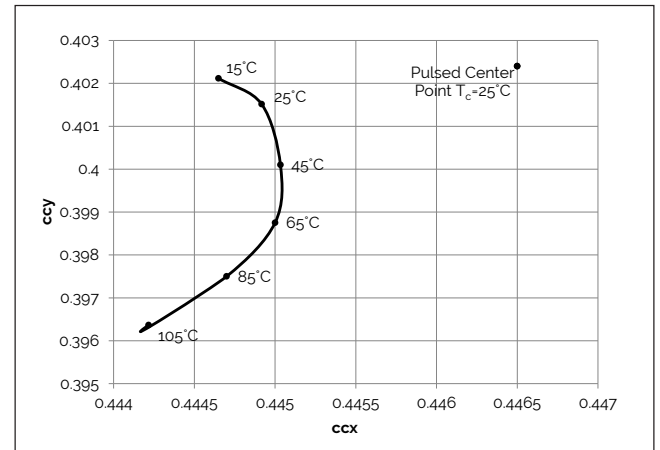

Figure 9: 3000K, 90 CRI Color Shift vs. Case Temperature³



Notes for Figures 6-9:

1. Measurements made under DC test conditions at the nominal drive current.
2. Typical color shift is shown with a tolerance of ±0.002.
3. Characteristics shown for Decor Series Showcase products, BXRH-30G060C-x-73

Typical Radiation Pattern

Figure 10: Typical Spatial Radiation Pattern

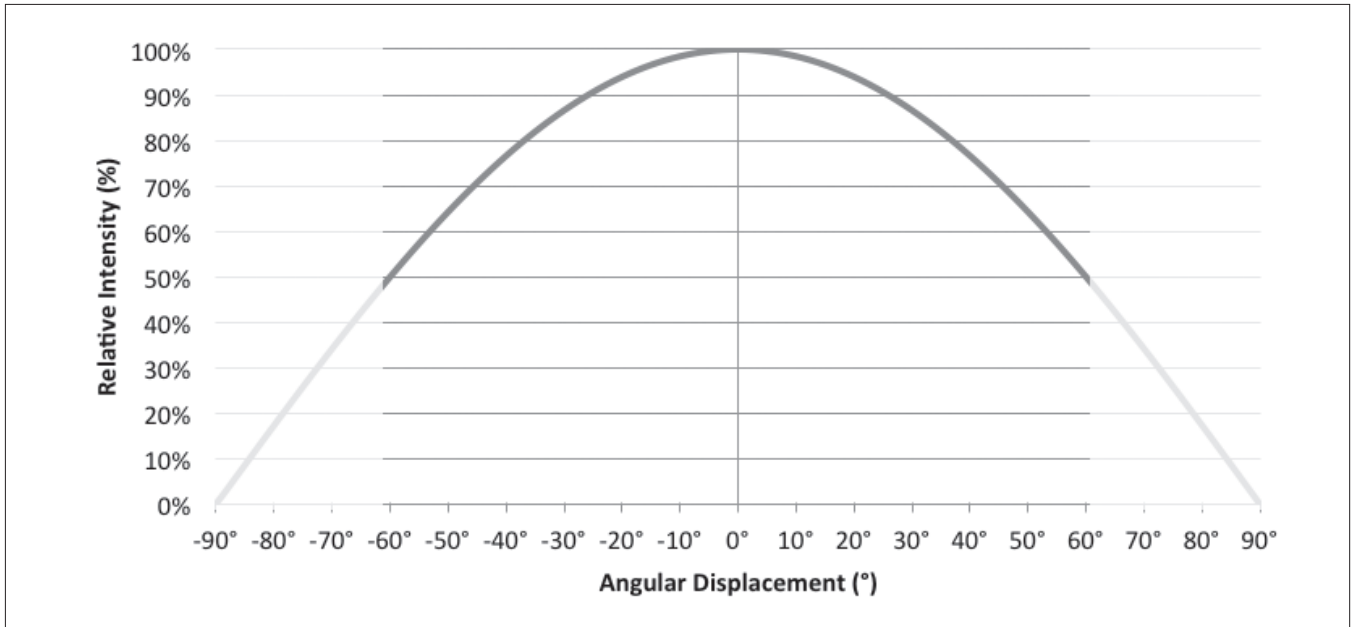

Notes for Figure 10:

1. Typical viewing angle is 120°.
2. The viewing angle is defined as the off axis angle from the centerline where intensity is ½ of the peak value.

Figure 11: Typical Polar Radiation Pattern

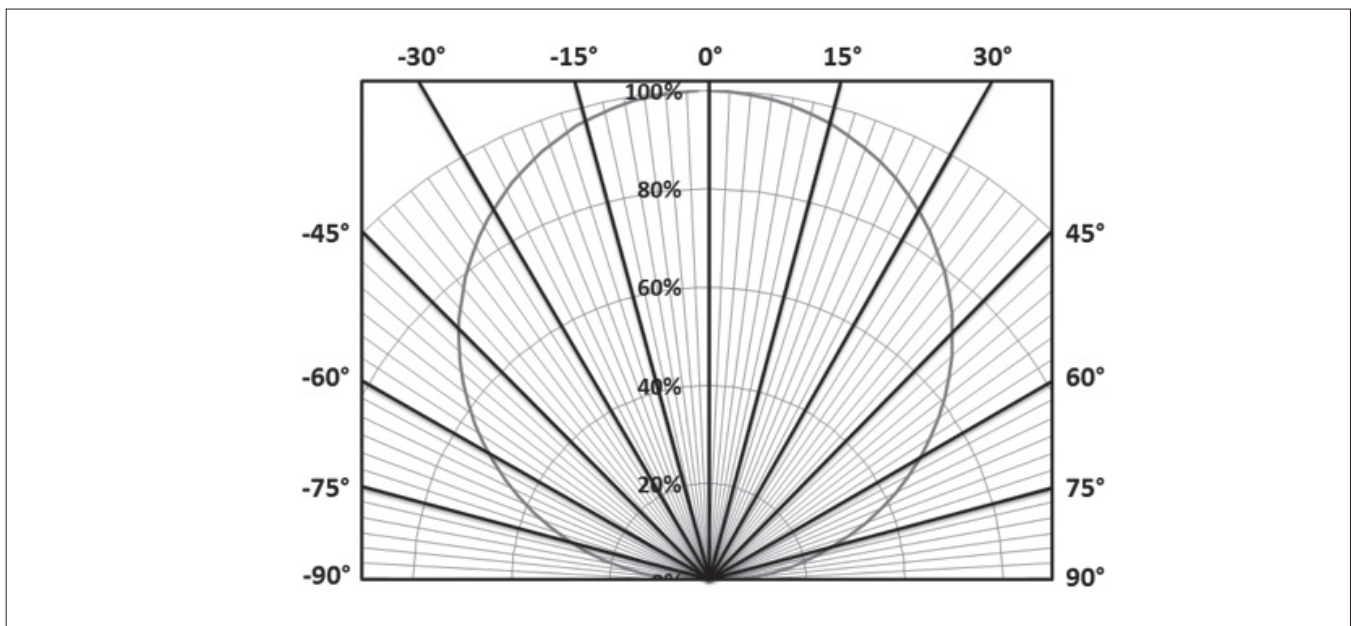

Typical Color Spectrum

Figure 12: Typical Color Spectrum

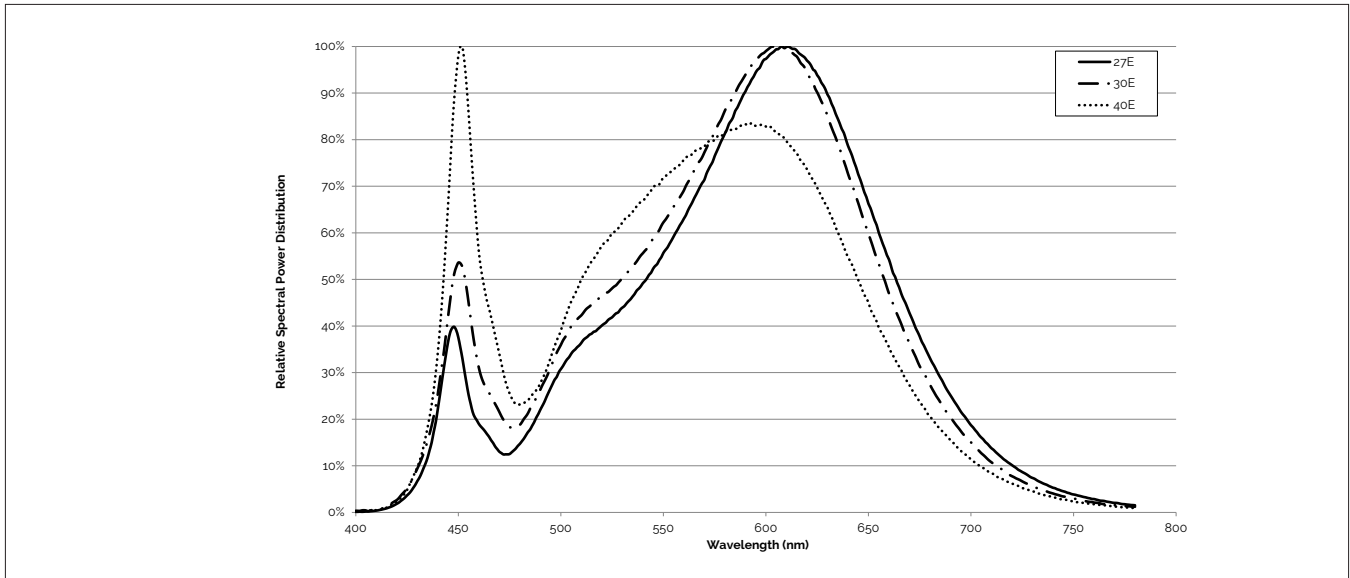

Notes for Figure 12:

1. Color spectra measured at nominal current for $T_j = T_c = 25^\circ\text{C}$.
2. Color spectra shown is 2700K and 80 CRI.
3. Color spectra shown is 3000K and 80 CRI.
4. Color spectra shown is 4000K and 80 CRI.

Figure 13: Typical Color Spectrum for Décor Series

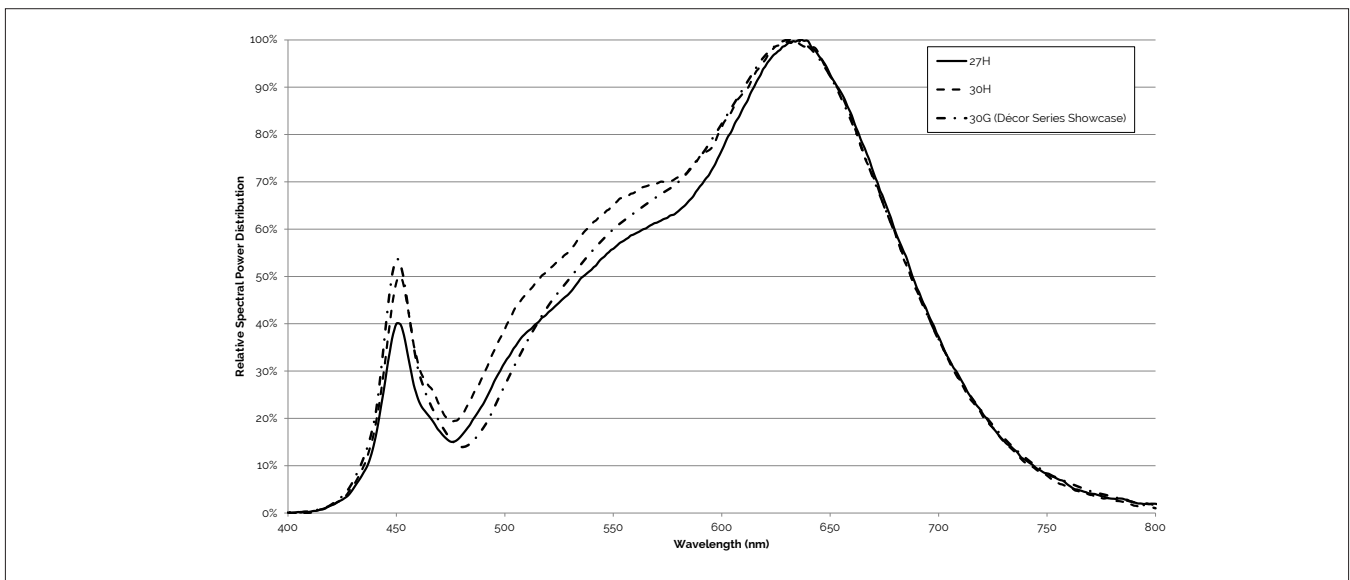

Note for Figure 13:

1. Color spectra measured at nominal current for $T_j = T_c = 25^\circ\text{C}$.

Mechanical Dimensions

Figure 14: Drawing for V4 HD LED Array

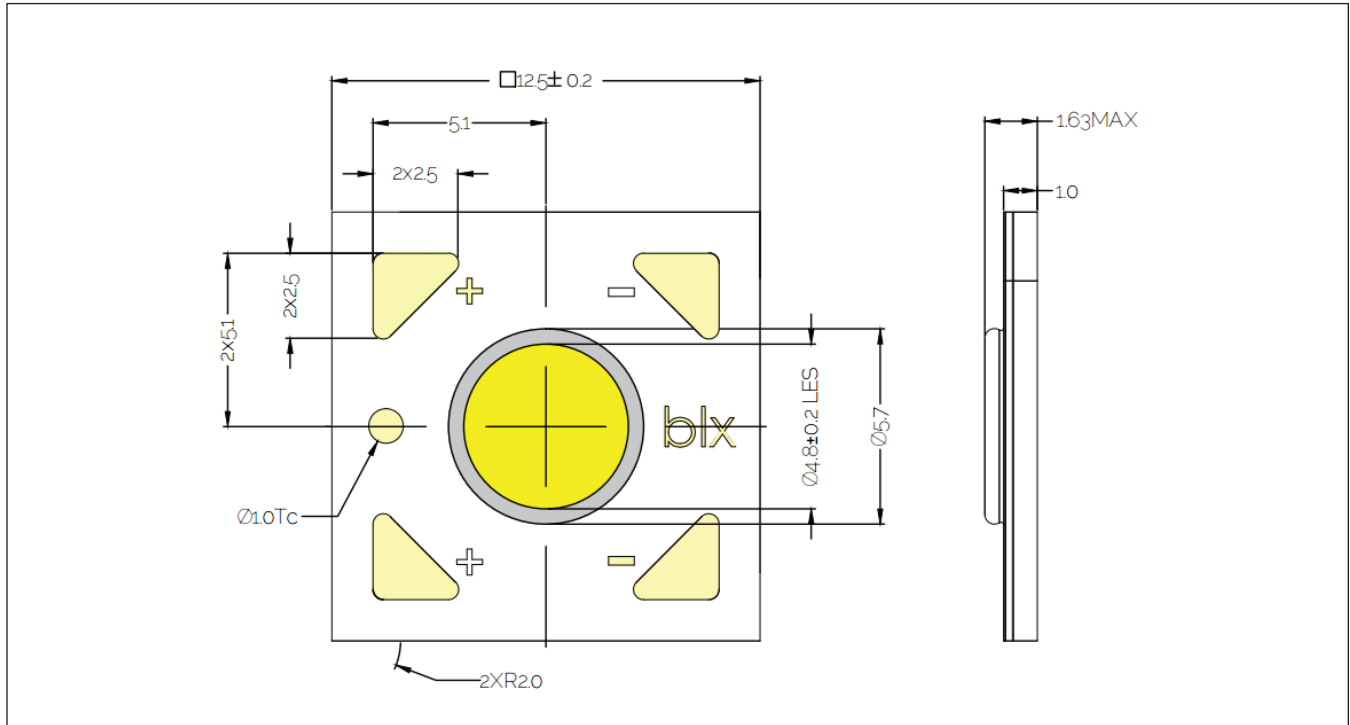

Notes for Figure 14:

1. Drawings are not to scale.
2. Drawing dimensions are in millimeters.
3. Unless otherwise specified, tolerances are ± 0.1 mm.
4. Solder pad labeled "+" denotes positive contact.
5. Refer to Application Notes AN101 for product handling, mounting and heat sink recommendations.
6. The optical center of the LED Array is nominally defined by the mechanical center of the array to a tolerance of ± 0.2 mm.
7. Bridgelux maintains a flatness of 0.10mm across the mounting surface of the array.

Color Binning Information

Figure 15: Warm and Neutral White Test Bins in xy Color Space

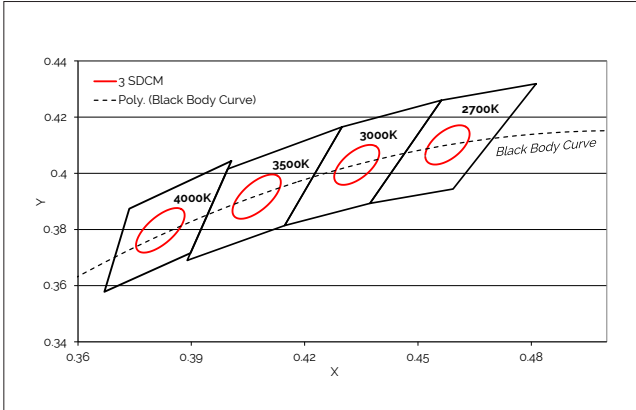

Note: Pulsed Test Conditions, $T_c = 25^\circ\text{C}$

Figure 16: Cool White Test Bins in xy Color Space

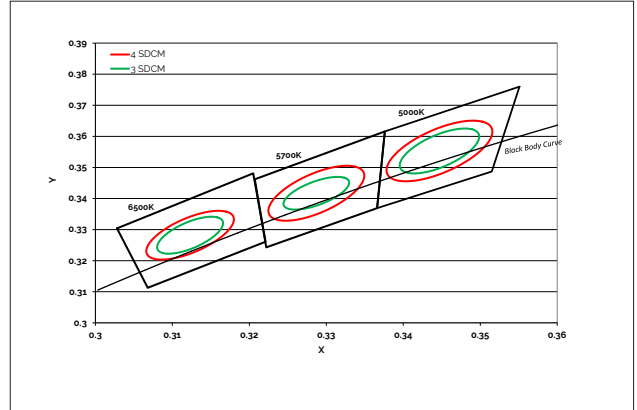

Note: Pulsed Test Conditions, $T_c = 85^\circ\text{C}$

Table 8: Warm and Neutral White xy Bin Coordinates and Associated Typical CCT

Bin Code	2700K	3000K	3500K ¹	4000K
ANSI Bin (for reference only)	(2580K - 2870K)	(2870K - 3220K)	(3220K - 3710K)	(3710K - 4260K)
73 (3 SDCM)	(2651K - 2794K)	(2968K - 3136K)	(3369K - 3586K)	(3851K - 4130K)
Center Point (x,y)	(0.4578, 0.4101)	(0.4338, 0.403) (0.4465, 0.4024) ²	(0.4073, 0.3917)	(0.3818, 0.3797)

Table 9: Cool White xy Bin Coordinates and Associated Typical CCT (product is hot targeted to $T_c = 85^\circ\text{C}$)

Bin Code	5000K	5700K	6500K
ANSI Bin (for reference only)	(4745K - 5311K)	(5312K - 6022K)	(6022K - 7042K)
84 (4 SDCM)	(4801K - 5282K)	(5395K - 5970K)	(6200K - 6910K)
83 (3 SDCM)	(4835K - 5215K)	(5460K - 5891K)	(6279K - 6811K)
Center Point (x,y)	(0.3447, 0.3553)	(0.3287, 0.3417)	(0.3123, 0.3282)

Notes for Table 8-9:

- Color Binning information excludes Décor Series Class A products. Please contact your Bridgelux Sales Representative for more information.
- Center Point for Décor Series Showcase.
- Bridgelux maintains a tolerance of +/- 0.007 on x and y color coordinates in the CIE 1931 color Space.

Packaging and Labeling

Figure 17: V4 HD Packaging Tube

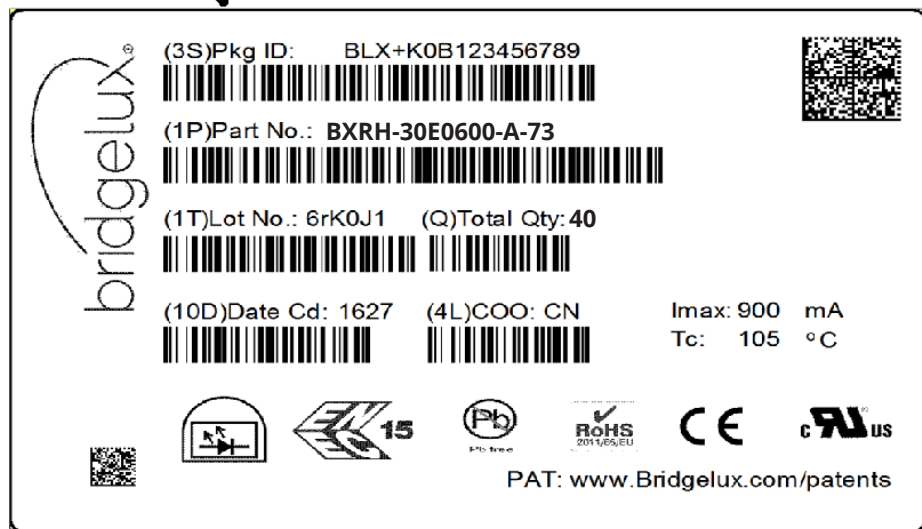

Box Label

Commercial Invoice
and Packing list



Notes for Figure 17:

1. Each tube holds 40 V4 HD COB arrays.
2. One tube is sealed in an anti-static bag. Four bags are placed in a shipping box. Depending on quantities ordered, a bigger shipping box, containing four boxes may be used to ship products.
3. Each bag and box is to be labeled as shown above.
4. Dimensions for each tube are 14.3 (W) x 8.3(H) x 530 (L) mm. Dimensions for the anti-static bag are 75 (W) x 615 (L) x 0.075 (T) mm. Dimensions for the shipping box are 58.7 x 13.3 x 7.9 cm

Packaging and Labeling

Figure 18: V Series HD Product Labeling

Bridgelux COB arrays have laser markings on the back side of the substrate to help with product identification. In addition to the product identification markings, Bridgelux COB arrays also contain markings for internal Bridgelux manufacturing use only. The image below shows which markings are for customer use and which ones are for Bridgelux internal use only. The Bridgelux internal manufacturing markings are subject to change without notice, however these will not impact the form, function or performance of the COB array.



Design Resources

Application Notes

Bridgelux has developed a comprehensive set of application notes and design resources to assist customers in successfully designing with the V Series HD product family of LED array products. For all available application notes visit www.bridgelux.com.

Optical Source Models

Optical source models and ray set files are available for all Bridgelux products. For a list of available formats, visit www.bridgelux.com.

3D CAD Models

Three dimensional CAD models depicting the product outline of all Bridgelux V Series HD LED arrays are available in both IGS and STEP formats. Please contact your Bridgelux sales representative for assistance.

LM80

LM80 testing has been completed and the LM80 report is now available. Please contact your Bridgelux sales representative for LM-80 report.

Precautions

CAUTION: CHEMICAL EXPOSURE HAZARD

Exposure to some chemicals commonly used in luminaire manufacturing and assembly can cause damage to the LED array. Please consult Bridgelux Application Note AN101 for additional information.

CAUTION: RISK OF BURN

Do not touch the V Series HD LED array during operation. Allow the array to cool for a sufficient period of time before handling. The V Series HD LED array may reach elevated temperatures such that could burn skin when touched.

CAUTION

CONTACT WITH LIGHT EMITTING SURFACE (LES)

Avoid any contact with the LES. Do not touch the LES of the LED array or apply stress to the LES (yellow phosphor resin area). Contact may cause damage to the LED array.

Optics and reflectors must not be mounted in contact with the LES (yellow phosphor resin area).

Disclaimers

MINOR PRODUCT CHANGE POLICY

The rigorous qualification testing on products offered by Bridgelux provides performance assurance. Slight cosmetic changes that do not affect form, fit, or function may occur as Bridgelux continues product optimization.

STANDARD TEST CONDITIONS

Unless otherwise stated, array testing is performed at the nominal drive current.

About Bridgelux: Bridging Light and Life™

At Bridgelux, we help companies, industries and people experience the power and possibility of light. Since 2002, we've designed LED solutions that are high performing, energy efficient, cost effective and easy to integrate. Our focus is on light's impact on human behavior, delivering products that create better environments, experiences and returns—both experiential and financial. And our patented technology drives new platforms for commercial and industrial luminaires.

For more information about the company, please visit
bridgelux.com
twitter.com/Bridgelux
facebook.com/Bridgelux
youtube.com/user/Bridgelux
linkedin.com/company/bridgelux-inc-_2
WeChat ID: BridgeluxInChina



46410 Fremont Boulevard
Fremont, CA 94538 U.S.A.
Tel (925) 583-8400
www.bridgelux.com

© 2021 Bridgelux, Inc. All rights reserved 2018. Product specifications are subject to change without notice. Bridgelux, the Bridgelux stylized logo design and Vero are registered trademarks. V Series and Decor Series are trademarks of Bridgelux, Inc. All other trademarks are the property of their respective owners.

Bridgelux V4 HD Array Series Product Data Sheet DS400 Rev. G (11/2022)