

# Bridgelux® SMD 2835 0.2W 3V

Product Data Sheet DS517

# Introduction

SMD 2835



Bridgelux F90 Series combine unique phosphor and packaging technology to achieve today's CR180 LED flux with a CRI of 90. It can be incorporated in virtually any luminaire (such as linear lamps, downlights, spotlights, high-bay) and can increase the vividness of strong red colors which is particularly desirable in retail applications.

## Features

- Industry-standard 2835 footprint
- Enables 3- and 6-step MacAdam ellipse custom binning kits
- RoHS compliant and lead free
- Multiple CCT configurations for a wide range of lighting applications

## Benefits

- Lower operating and manufacturing cost
- Ease of design and rapid go-to-market
- Uniform, consistent white light
- Reliable and constant white point
- Compliant with environmental standards
- Design flexibility

# Contents

|   |    |
|---|----|
| Product Feature Map                         | 2  |
| Product Nomenclature                        | 2  |
| Product Selection Guide                     | 3  |
| Performance at Commonly Used Drive Currents | 4  |
| Electrical Characteristics                  | 5  |
| Absolute Maximum Ratings                    | 6  |
| Product Bin Definitions                     | 7  |
| Performance Curves                          | 10 |
| Typical Radiation Pattern                   | 13 |
| Typical Color Spectrum                      | 14 |
| Mechanical Dimensions                       | 15 |
| Reliability                                 | 16 |
| Reflow Characteristics                      | 17 |
| Packaging                                   | 18 |
| Design Resources                            | 20 |
| Precautions                                 | 20 |
| Disclaimers                                 | 20 |
| About Bridgelux                             | 21 |

# Product Feature Map

Bridgelux SMD LED products come in industry standard package sizes and follow ANSI binning standards. These LEDs are optimized for cost and performance, helping to ensure highly competitive system lumen per dollar performance while addressing the stringent efficacy and reliability standards required for modern lighting applications.

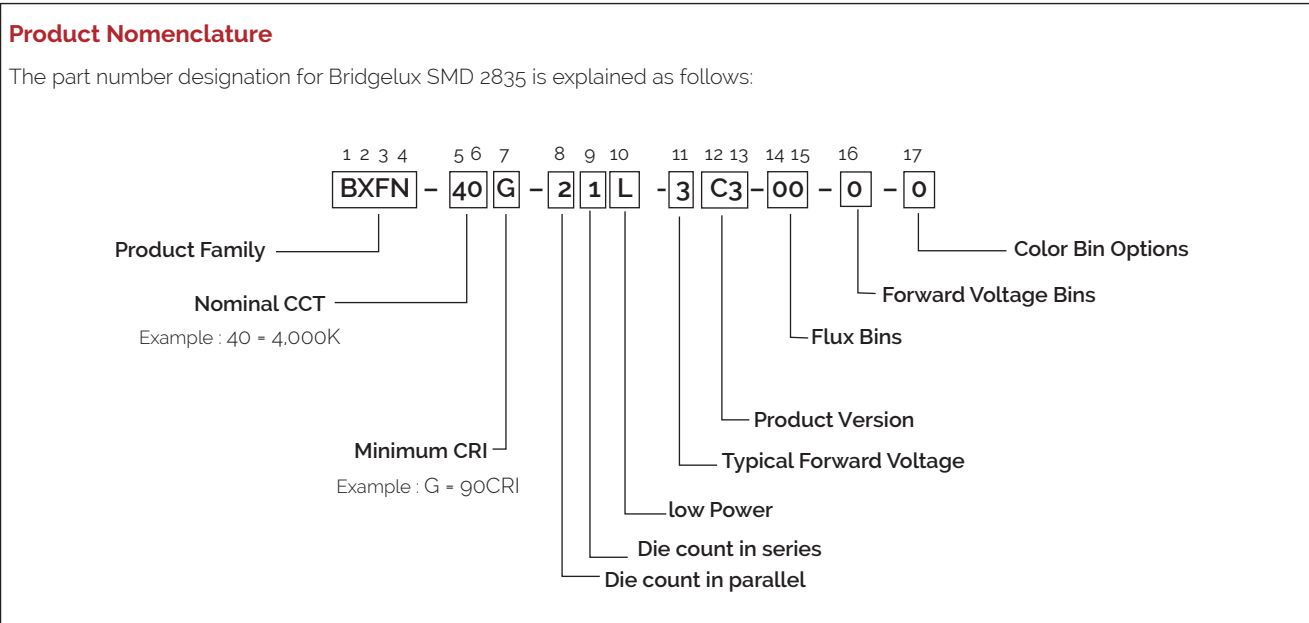
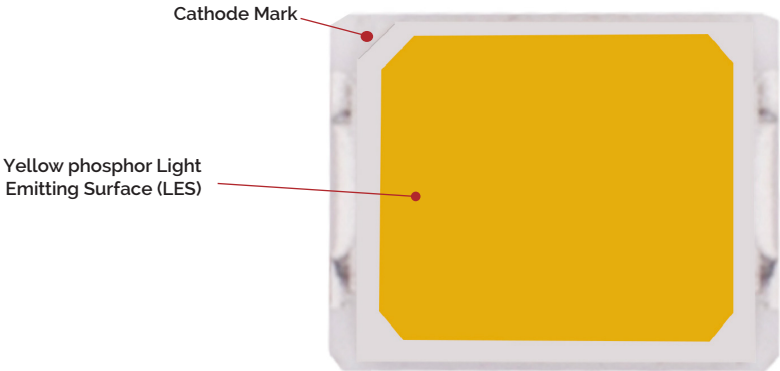

# Product Selection Guide

The following product configurations are available:

**Table 1:** Selection Guide, Pulsed Measurement Data at 65mA ( $T_j = T_{sp} = 25^\circ\text{C}$ )

| Part Number <sup>1,6</sup> | Nominal CCT <sup>2</sup> (K) | CRI <sup>3,5</sup> | Nominal Drive Current (mA) | Forward Voltage <sup>4,5</sup> (V) |         |      | Typical Pulsed Flux (lm) <sup>4,5</sup> | Typical Power (W) | Typical Efficacy (lm/W) |
|----------------------------|------------------------------|--------------------|----------------------------|------------------------------------|---------|------|---|-------------------|-------------------------|
|                            |                              |                    |                            | Min                                | Typical | Max  |   |                   |                         |
| BXFN-27G-21L-3C3-00-0-0    | 2700                         | 89                 | 65                         | 2.60                               | 2.75    | 3.00 | 33.5                                    | 0.2               | 187                     |
| BXFN-30G-21L-3C3-00-0-0    | 3000                         | 89                 | 65                         | 2.60                               | 2.75    | 3.00 | 34.0                                    | 0.2               | 190                     |
| BXFN-35G-21L-3C3-00-0-0    | 3500                         | 89                 | 65                         | 2.60                               | 2.75    | 3.00 | 34.0                                    | 0.2               | 190                     |
| BXFN-40G-21L-3C3-00-0-0    | 4000                         | 88                 | 65                         | 2.60                               | 2.75    | 3.00 | 34.8                                    | 0.2               | 195                     |
| BXFN-50G-21L-3C3-00-0-0    | 5000                         | 88                 | 65                         | 2.60                               | 2.75    | 3.00 | 34.8                                    | 0.2               | 195                     |
| BXFN-57G-21L-3C3-00-0-0    | 5700                         | 88                 | 65                         | 2.60                               | 2.75    | 3.00 | 34.2                                    | 0.2               | 191                     |
| BXFN-65G-21L-3C3-00-0-0    | 6500                         | 88                 | 65                         | 2.60                               | 2.75    | 3.00 | 34.2                                    | 0.2               | 191                     |

**Table 2:** Selection Guide, Pulsed Test Performance ( $T_{sp} = 85^\circ\text{C}$ )<sup>7,8</sup>

| Part Number <sup>1,6</sup> | Nominal CCT <sup>2</sup> (K) | CRI <sup>3,5</sup> | Nominal Drive Current (mA) | Forward Voltage <sup>4,5</sup> (V) |         |      | Typical Pulsed Flux (lm) <sup>4,5</sup> | Typical Power (W) | Typical Efficacy (lm/W) |
|----------------------------|------------------------------|--------------------|----------------------------|------------------------------------|---------|------|---|-------------------|-------------------------|
|                            |                              |                    |                            | Min                                | Typical | Max  |   |                   |                         |
| BXFN-27G-21L-3C3-00-0-0    | 2700                         | 90                 | 65                         | 2.50                               | 2.65    | 2.90 | 30.2                                    | 0.2               | 175                     |
| BXFN-30G-21L-3C3-00-0-0    | 3000                         | 90                 | 65                         | 2.50                               | 2.65    | 2.90 | 30.7                                    | 0.2               | 178                     |
| BXFN-35G-21L-3C3-00-0-0    | 3500                         | 90                 | 65                         | 2.50                               | 2.65    | 2.90 | 30.7                                    | 0.2               | 178                     |
| BXFN-40G-21L-3C3-00-0-0    | 4000                         | 90                 | 65                         | 2.50                               | 2.65    | 2.90 | 31.4                                    | 0.2               | 182                     |
| BXFN-50G-21L-3C3-00-0-0    | 5000                         | 90                 | 65                         | 2.50                               | 2.65    | 2.90 | 31.4                                    | 0.2               | 182                     |
| BXFN-57G-21L-3C3-00-0-0    | 5700                         | 90                 | 65                         | 2.50                               | 2.65    | 2.90 | 30.9                                    | 0.2               | 179                     |
| BXFN-65G-21L-3C3-00-0-0    | 6500                         | 90                 | 65                         | 2.50                               | 2.65    | 2.90 | 30.9                                    | 0.2               | 179                     |

Notes for Tables 1 & 2:

- The last 6 characters (including hyphens '-') refer to flux bins, forward voltage bins, and color bin options, respectively. "00-0-0" denotes the full distribution of flux, forward voltage, and color bin.  
Example: BXFN-40G-21L-3C3-00-0-0 refers to the full distribution of flux, forward voltage, and color within a 4000K 6-step ANSI standard chromaticity region with a minimum of 88 CRI and typical of 90 CRI, 2x1 die configuration, low power, 2.75V typical forward voltage.
- Product CCT is the nominal CCT at  $T_{sp} = 25^\circ\text{C}$  as defined by ANSI C78.377-2011.
- Listed CRIs are minimum values and include test tolerance.
- Products tested under pulsed condition (10ms pulse width) at nominal Drive current.
- Bridgelux maintains a  $\pm 7.5\%$  tolerance on flux measurements,  $\pm 0.15\text{V}$  tolerance on forward voltage measurements, and  $\pm 2$  tolerance on CRI measurements for the SMD 2835.
- Refer to Table 6 and Table 7 for Bridgelux SMD 2835 flux Binning and Forward Voltage Binning information.
- Typical pulsed test performance values are provided as reference only and are not a guarantee of performance.
- Typical performance is estimated based on operation under pulsed current with LED emitter mounted onto a heat sink with thermal interface material and the solder point temperature maintained at  $85^\circ\text{C}$ . Based on Bridgelux test setup, values may vary depending on the thermal design of the luminaire and the exposed environment to which the product is subjected.
- In order to ensure the accuracy of the test by Everfine sphere the test model suggest to use conventional test preheat for 30ms integrating time for 20ms. If using pulse model, pulse width suggest to use IP 80-90%. Hot cold test must use conventional test and wavelength accuracy is required to be 1nm. The test conditions must be fixed.

# Performance at Commonly Used Drive Currents

SMD 2835 LEDs are tested to the specifications shown using the nominal drive currents in Table 1. SMD 2835 may also be driven at other drive currents dependent on specific application design requirements. The performance at any drive current can be derived from the current vs. voltage characteristics shown in Figure 2 and the relative luminous flux vs. current characteristics shown in Figure 3. The performance at commonly used drive currents is summarized in Table 3.

**Table 3:** Performance at Commonly Used Drive Currents

| Part Number             | Drive Current <sup>1</sup> (mA) | Typical $V_f$<br>$T_{sp} = 25^\circ\text{C}$ (V) | Typical Power<br>$T_{sp} = 25^\circ\text{C}$ (W) | Typical Pulsed Flux <sup>2</sup><br>$T_{sp} = 25^\circ\text{C}$ (lm) | Typical Pulsed Flux <sup>3</sup><br>$T_{sp} = 85^\circ\text{C}$ (lm) | Typical Efficacy<br>$T_{sp} = 25^\circ\text{C}$ (lm/W) |
|-------------------------|---------------------------------|--|--|--|--|--|
| BXFN-27G-21L-3C3-00-0-0 | 40                              | 2.69   | 0.1  | 21.1   | 19.1   | 196  |
|                         | 60                              | 2.73   | 0.2  | 31.5   | 28.5   | 192  |
|                         | 100                             | 2.80   | 0.3  | 51.5   | 46.4   | 184  |
|                         | 120                             | 2.83   | 0.3  | 61.0   | 55.1   | 180  |
|                         | 150                             | 2.88   | 0.4  | 75.1   | 67.8   | 174  |
| BXFN-30G-21L-3C3-00-0-0 | 40                              | 2.69   | 0.1  | 21.4   | 19.4   | 199  |
|                         | 60                              | 2.73   | 0.2  | 31.9   | 28.9   | 195  |
|                         | 100                             | 2.80   | 0.3  | 52.2   | 47.1   | 186  |
|                         | 120                             | 2.83   | 0.3  | 61.9   | 55.9   | 182  |
|                         | 150                             | 2.88   | 0.4  | 76.1   | 68.8   | 176  |
| BXFN-35G-21L-3C3-00-0-0 | 40                              | 2.69   | 0.1  | 21.5   | 19.5   | 200  |
|                         | 60                              | 2.73   | 0.2  | 32.1   | 29.0   | 196  |
|                         | 100                             | 2.80   | 0.3  | 52.4   | 47.4   | 187  |
|                         | 120                             | 2.83   | 0.3  | 62.2   | 56.2   | 183  |
|                         | 150                             | 2.88   | 0.4  | 76.6   | 69.1   | 177  |
| BXFN-40G-21L-3C3-00-0-0 | 40                              | 2.69   | 0.1  | 22.0   | 19.9   | 204  |
|                         | 60                              | 2.73   | 0.2  | 32.7   | 29.6   | 200  |
|                         | 100                             | 2.80   | 0.3  | 53.5   | 48.3   | 191  |
|                         | 120                             | 2.83   | 0.3  | 63.5   | 57.3   | 187  |
|                         | 150                             | 2.88   | 0.4  | 78.0   | 70.5   | 181  |
| BXFN-50G-21L-3C3-00-0-0 | 40                              | 2.69   | 0.1  | 22.0   | 19.9   | 204  |
|                         | 60                              | 2.73   | 0.2  | 32.7   | 29.6   | 200  |
|                         | 100                             | 2.80   | 0.3  | 53.5   | 48.3   | 191  |
|                         | 120                             | 2.83   | 0.3  | 63.5   | 57.3   | 187  |
|                         | 150                             | 2.88   | 0.4  | 78.0   | 70.5   | 181  |
| BXFN-57G-21L-3C3-00-0-0 | 40                              | 2.69   | 0.1  | 21.5   | 19.5   | 200  |
|                         | 60                              | 2.73   | 0.2  | 32.1   | 29.0   | 196  |
|                         | 100                             | 2.80   | 0.3  | 52.4   | 47.4   | 187  |
|                         | 120                             | 2.83   | 0.3  | 62.2   | 56.2   | 183  |
|                         | 150                             | 2.88   | 0.4  | 76.6   | 69.1   | 177  |
| BXFN-65G-21L-3C3-00-0-0 | 40                              | 2.69   | 0.1  | 21.5   | 19.5   | 200  |
|                         | 60                              | 2.73   | 0.2  | 32.1   | 29.0   | 196  |
|                         | 100                             | 2.80   | 0.3  | 52.4   | 47.4   | 187  |
|                         | 120                             | 2.83   | 0.3  | 62.2   | 56.2   | 183  |
|                         | 150                             | 2.88   | 0.4  | 76.6   | 69.1   | 177  |

Notes for Table 3:

1. Alternate drive currents in Table 3 are provided for reference only and are not a guarantee of performance.
2. Bridgelux maintains a  $\pm 7.5\%$  tolerance on flux measurements.
3. Typical performance values are provided as reference only and are not a guarantee of performance.

# Electrical Characteristics

**Table 4:** Electrical Characteristics

| Part Number <sup>1</sup> | Drive Current (mA) | Forward Voltage (V) <sup>2</sup> |         |         | Typical Temperature Coefficient of Forward Voltage $\Delta V_f / \Delta T$ (mV/°C) | Typical Thermal Resistance Junction to Solder Point <sup>4</sup> $R_{j-sp}$ (°C/W) |
|--------------------------|--------------------|----------------------------------|---------|---------|--|--|
|                          |                    | Minimum                          | Typical | Maximum |  |  |
| BXFN-XXG-21L-3C3-00-0-0  | 65                 | 2.60                             | 2.75    | 3.00    | -1.95  | 10.0   |

Notes for Table 4:

1. Bridgelux maintains a tolerance of  $\pm 0.15V$  on forward voltage measurements. Voltage minimum and maximum values at the nominal Test current are guaranteed by 100% test.
2. Products tested under pulsed condition (10ms pulse width) at nominal Drive current where  $T_{sp} = 25^{\circ}C$ .
3. Thermal resistance value was calculated using total electrical input power; optical power was not subtracted from input power.
4. Thermal resistance is only for the LED test values.

# Absolute Maximum Ratings

**Table 5:** Maximum Ratings

| Parameter  | Maximum Rating                                  |
|--|---|
| LED Junction Temperature ( $T_j$ )               | 125°C   |
| Storage Temperature                              | -40°C to +105°C                                 |
| Operating Solder Point Temperature ( $T_{sp}$ )  | -40°C to +105°C                                 |
| Soldering Temperature                            | 260°C or lower for a maximum of 10 seconds      |
| Maximum Drive Current                            | 180mA   |
| Maximum Peak Pulsed Forward Current <sup>1</sup> | 360mA   |
| Maximum Reverse Voltage <sup>2</sup>             | -   |
| Moisture Sensitivity Rating                      | MSL 4   |
| Electrostatic Discharge                          | 2kV HBM. JEDEC-JS-001-HBM and JEDEC-JS-001-2012 |

Notes for Table 5:

1. Bridgelux recommends a maximum duty cycle of 10% and pulse width of 10 ms when operating LED SMD at maximum peak pulsed current specified. Maximum peak pulsed current indicate values where LED SMD can be driven without catastrophic failures.
2. Light emitting diodes are not designed to be driven in reverse voltage and will not produce light under this condition. no rating is provided
3. The product is sensitive to moisture. It's not good to use for outdoor application or damp environment .



# Product Bin Definitions

Table 6 lists the standard photometric luminous flux bins for Bridgelux SMD 2835 LEDs. Although several bins are listed, product availability in a particular bin varies by production run and by product performance. Not all bins are available in all CCTs.

**Table 6:** Luminous flux Bin Definitions at 65mA,  $T_{sp}=25^{\circ}\text{C}$

| Bin Code | Minimum | Maximum | Unit | Condition         |
|----------|---------|---------|------|-------------------|
| 1E       | 30      | 32      | lm   | $I_F=65\text{mA}$ |
| 1F       | 32      | 34      |      |                   |
| 1G       | 34      | 36      |      |                   |
| 1H       | 36      | 38      |      |                   |

Note for Table 6:

1. Bridgelux maintains a tolerance of  $\pm 7.5\%$  on flux measurements.

**Table 7:** Forward Voltage Bin Definition at 65mA,  $T_{sp}=25^{\circ}\text{C}$

| Bin Code | Minimum | Maximum | Unit | Condition         |
|----------|---------|---------|------|-------------------|
| 8        | 2.6     | 2.7     | V    | $I_F=65\text{mA}$ |
| 9        | 2.7     | 2.8     |      |                   |
| A        | 2.8     | 2.9     |      |                   |
| B        | 2.9     | 3.0     |      |                   |

Note for Table 7:

1. Bridgelux maintains a tolerance of  $\pm 0.15\text{V}$  on forward voltage measurements.

# Product Bin Definitions

**Table 8:** MacAdam Ellipse Color Bin Definitions

| CCT   | Color Space | Center Point |        | Major Axis | Minor Axis | Ellipse Rotation Angle | Color Bin |
|-------|-------------|--------------|--------|------------|------------|------------------------|-----------|
|       |             | X            | Y      |            |            |                        |           |
| 2700K | 3 SDCM      | 0.4578       | 0.4101 | 0.0081     | 0.0042     | 53.70                  | 1         |
|       | 6 SDCM      | 0.4578       | 0.4101 | 0.0162     | 0.0084     | 53.70                  | 1/A/B/C/D |
| 3000K | 3 SDCM      | 0.4338       | 0.4030 | 0.00834    | 0.00408    | 53.22                  | 1         |
|       | 6 SDCM      | 0.4338       | 0.4030 | 0.01668    | 0.00816    | 53.22                  | 1/A/B/C/D |
| 3500K | 3 SDCM      | 0.4073       | 0.3917 | 0.00927    | 0.00414    | 54.00                  | 1         |
|       | 6 SDCM      | 0.4073       | 0.3917 | 0.01854    | 0.00828    | 54.00                  | 1/A/B/C/D |
| 4000K | 3 SDCM      | 0.3818       | 0.3797 | 0.00939    | 0.00402    | 53.72                  | 1         |
|       | 6 SDCM      | 0.3818       | 0.3797 | 0.01878    | 0.00804    | 53.72                  | 1/A/B/C/D |
| 5000K | 3 SDCM      | 0.3447       | 0.3553 | 0.00822    | 0.00354    | 59.62                  | 1         |
|       | 6 SDCM      | 0.3447       | 0.3553 | 0.01644    | 0.00708    | 59.62                  | 1/A/B/C/D |
| 5700K | 3 SDCM      | 0.3287       | 0.3417 | 0.00746    | 0.00320    | 59.09                  | 1         |
|       | 6 SDCM      | 0.3287       | 0.3417 | 0.01492    | 0.00640    | 59.09                  | 1/A/B/C/D |
| 6500K | 3 SDCM      | 0.3123       | 0.3282 | 0.00669    | 0.00285    | 58.57                  | 1         |
|       | 6 SDCM      | 0.3123       | 0.3282 | 0.01338    | 0.0057     | 58.57                  | 1/A/B/C/D |

Notes for Table 8:

1. Color binning at  $T_{sp} = 60^{\circ}\text{C}$  unless otherwise specified
2. Bridgelux maintains a tolerance of  $\pm 0.007$  on x and y color coordinates in the CIE 1931 color space.

# Product Bin Definitions

Figure 1: C.I.E. 1931 Chromaticity Diagram (5 Color Bin Structure, Hot-color Targeted at  $T_{sp} = 60^{\circ}\text{C}$ )

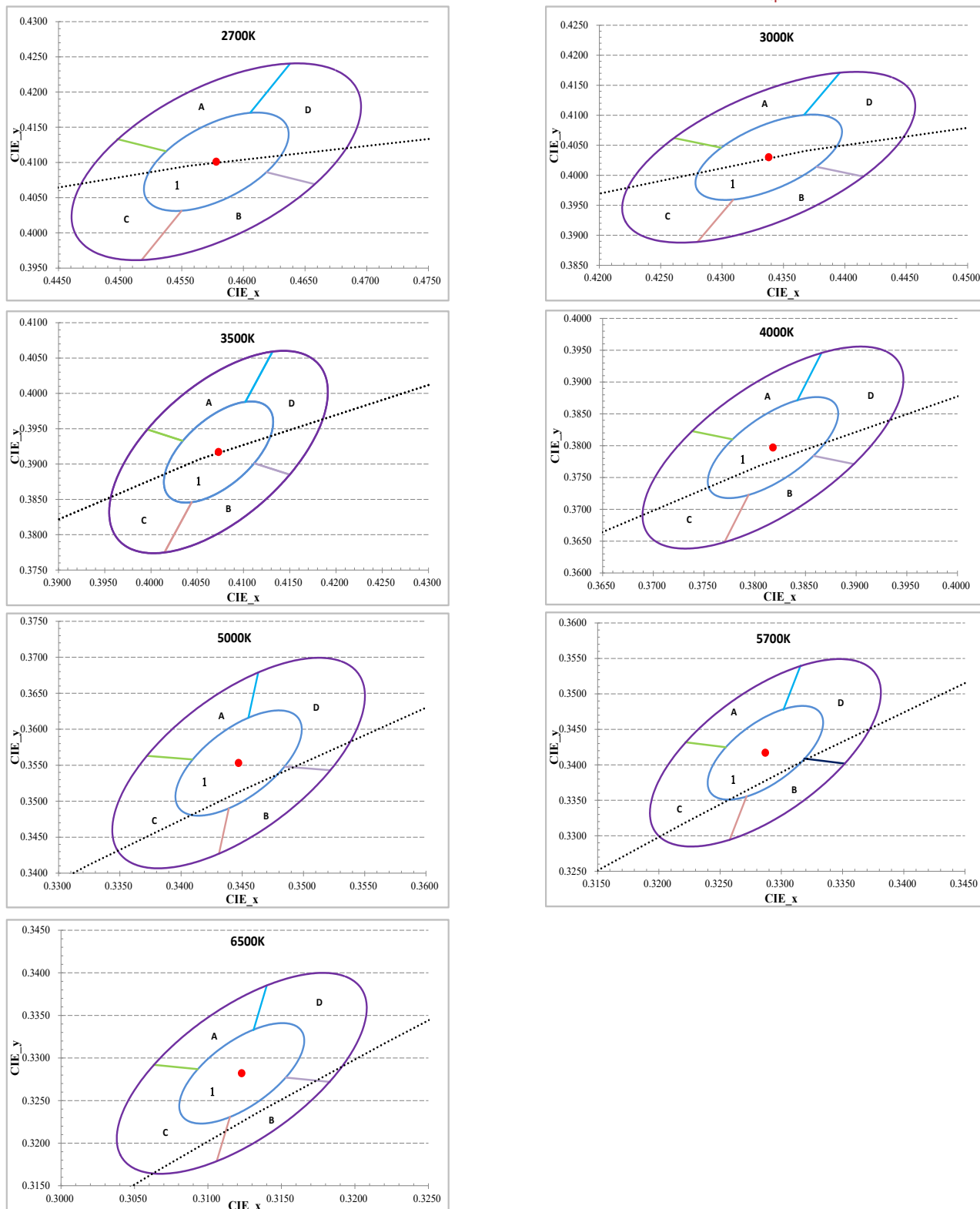

# Performance Curves

**Figure 2: Test Current vs. Forward Voltage ( $T_{sp}=25^{\circ}\text{C}$ )**

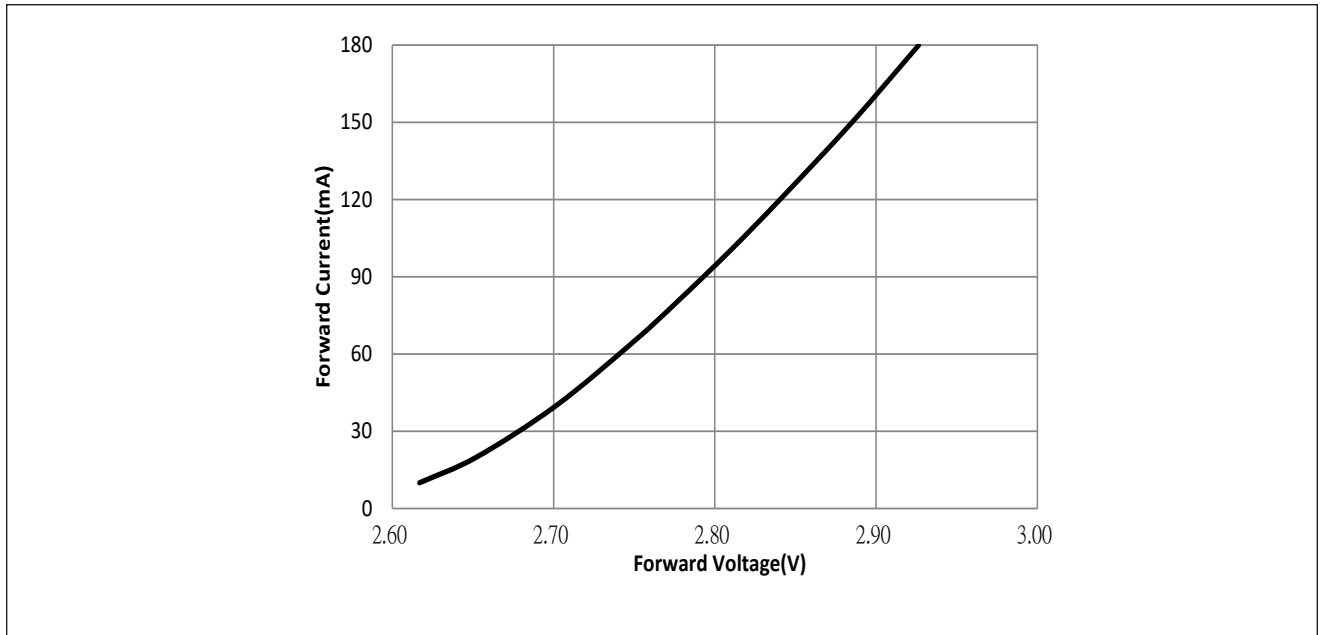

**Figure 3: Typical Relative Luminous Flux vs. Forward Current ( $T_{sp}=25^{\circ}\text{C}$ )**

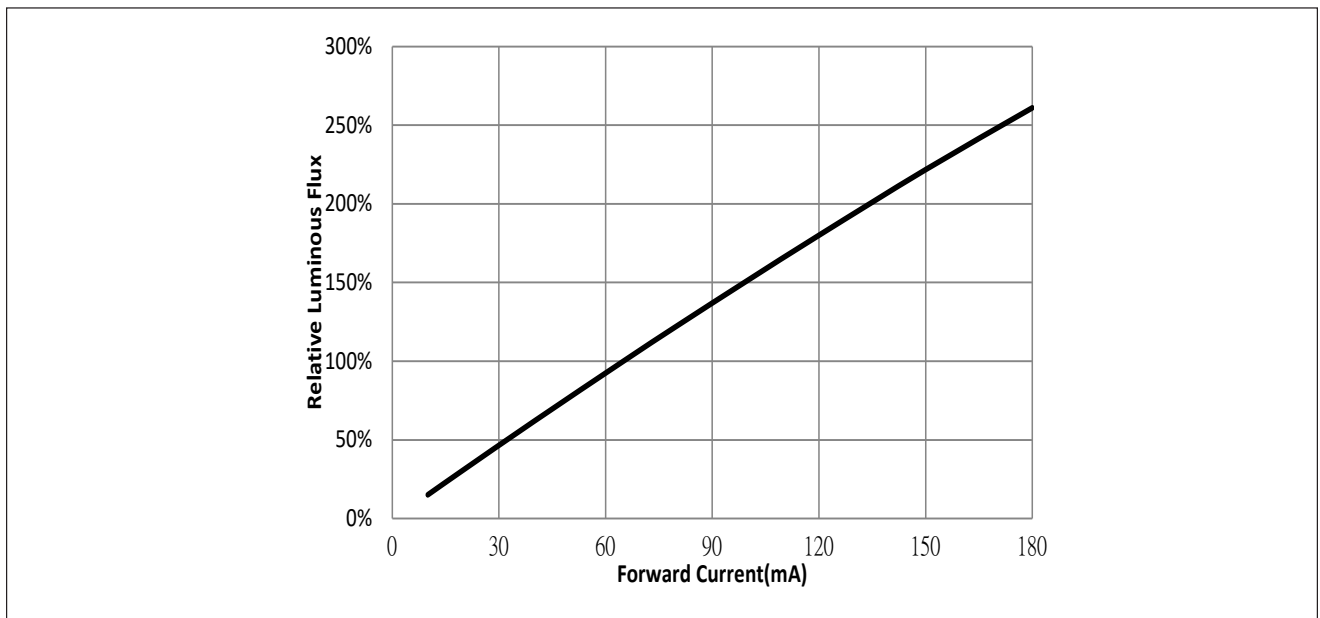

Note for Figure 3:

1. Pulse width modulation (PWM) is recommended for dimming effects.

# Performance Curves

**Figure 4: Typical Relative Flux vs. Solder Point Temperature**

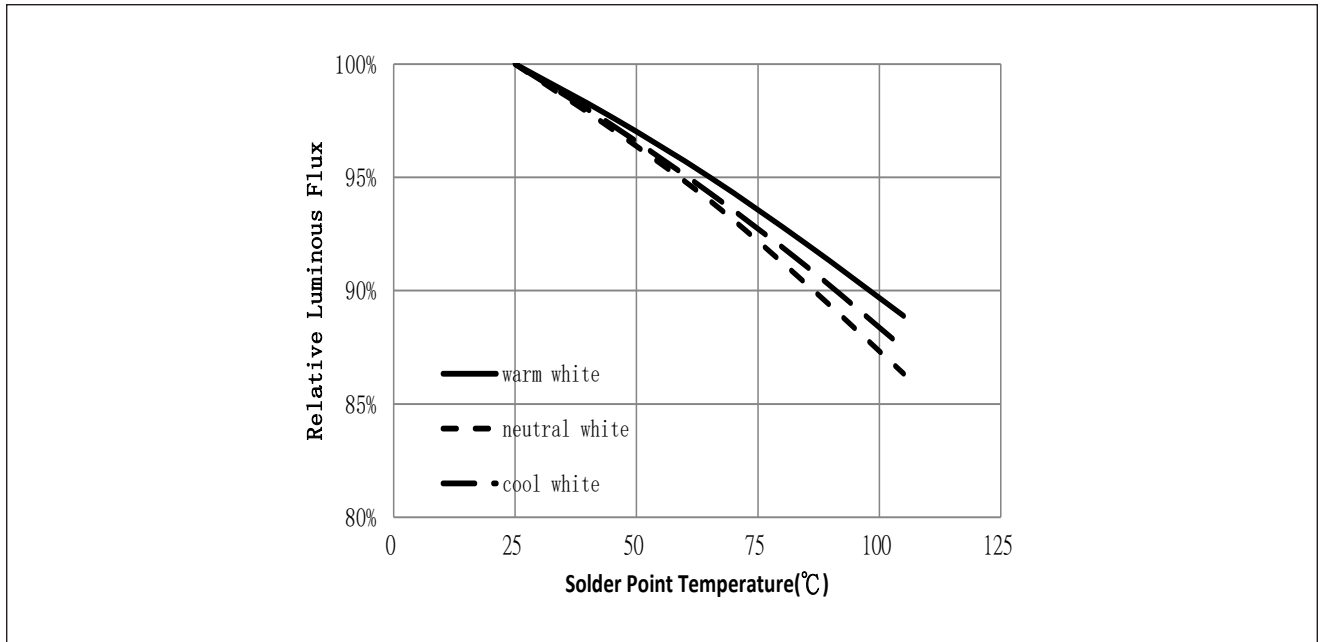

**Figure 5: Typical cxx Shift vs. Solder Point Temperature**

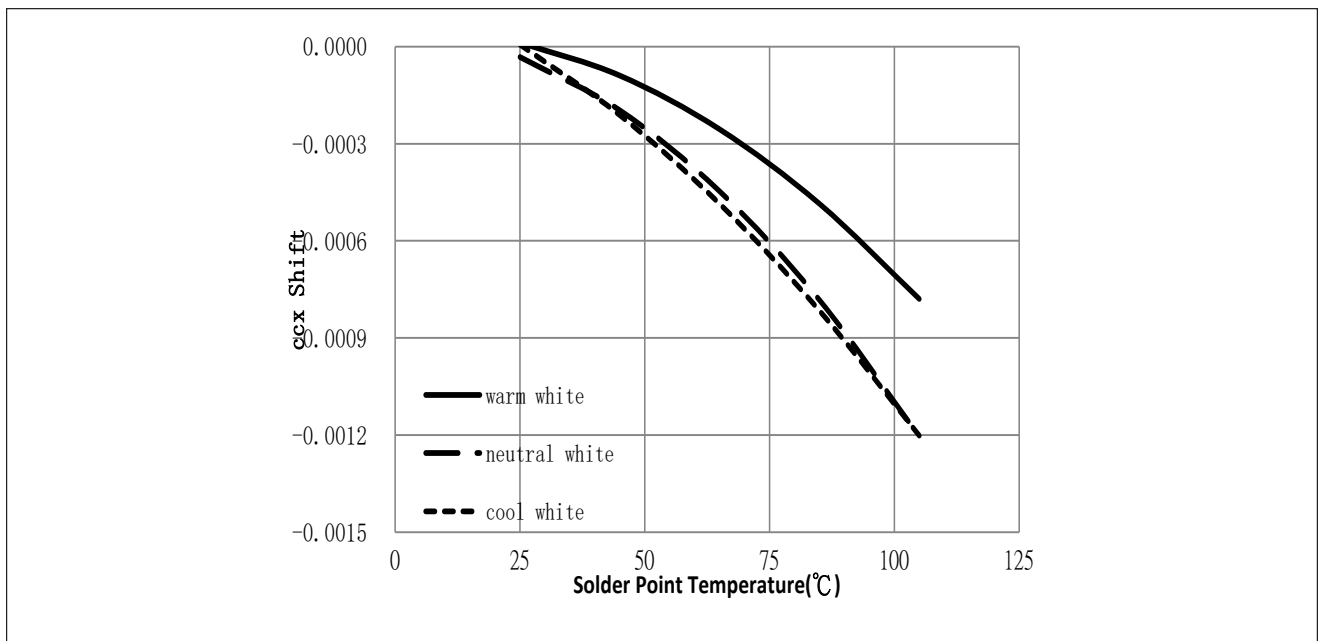

Notes for Figures 4 & 5:

1. Characteristics shown for warm white based on 2700K and 90 CRI.
1. Characteristics shown for neutral white based on 4000K and 90 CRI.
1. Characteristics shown for cool white based on 5000K and 90 CRI.
2. For other color SKUs, the shift in color will vary. Please contact your Bridgelux Sales Representative for more information

# Performance Curves

**Figure 6: Typical ccy Shift vs. Solder Point Temperature**

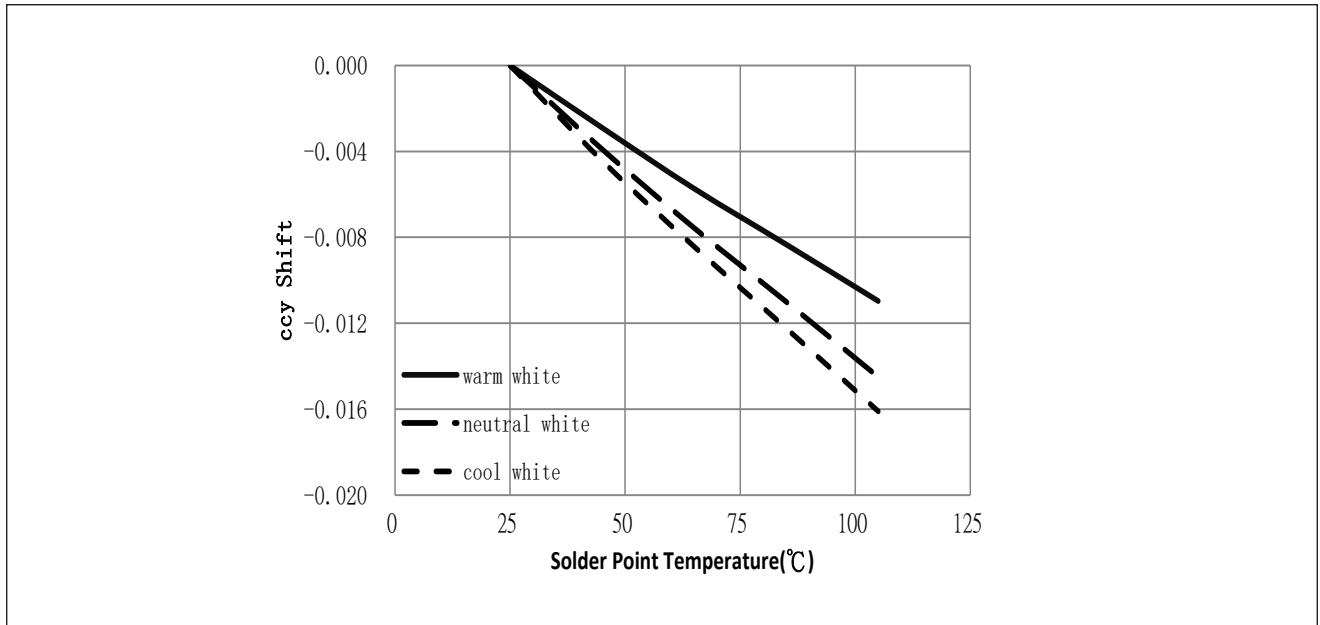

Notes for Figure 6:

1. Characteristics shown for warm white based on 2700K and 90 CRI.
1. Characteristics shown for neutral white based on 4000K and 90 CRI.
1. Characteristics shown for cool white based on 5000K and 90 CRI.
2. For other color SKUs, the shift in color will vary. Please contact your Bridgelux Sales Representative for more information

# Typical Radiation Pattern

Figure 7: Typical Spatial Radiation Pattern at 65mA,  $T_{sp} = 25^{\circ}\text{C}$

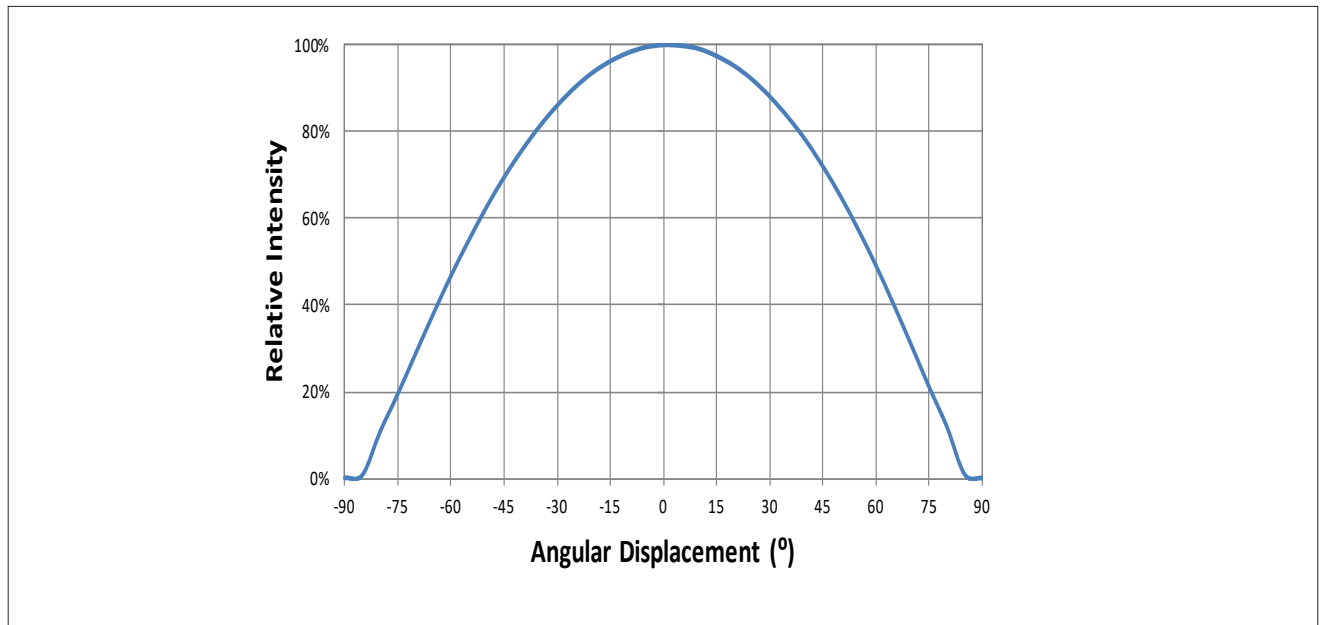

Notes for Figure 7:

1. Typical viewing angle is  $120^{\circ}$ .
2. The viewing angle is defined as the off axis angle from the centerline where luminous intensity (Iv) is  $\frac{1}{2}$  of the peak value.

Figure 8: Typical Polar Radiation Pattern at 65mA,  $T_{sp} = 25^{\circ}\text{C}$

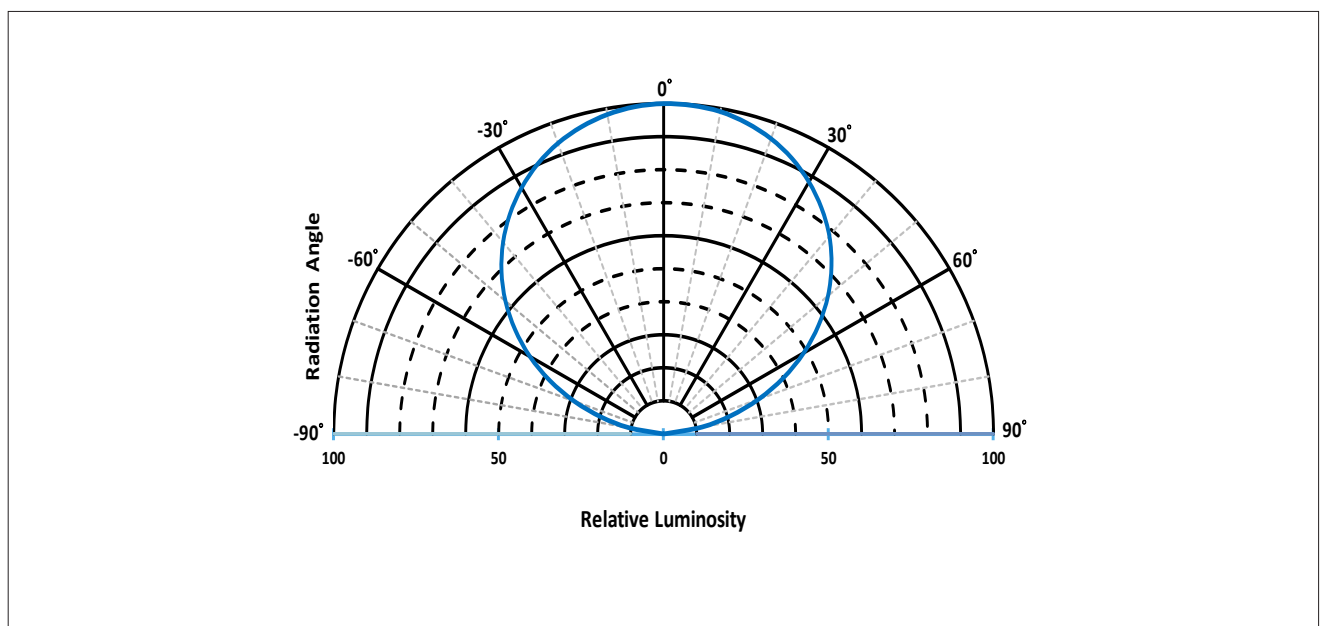

# Typical Color Spectrum

Figure 9: Typical Color Spectrum

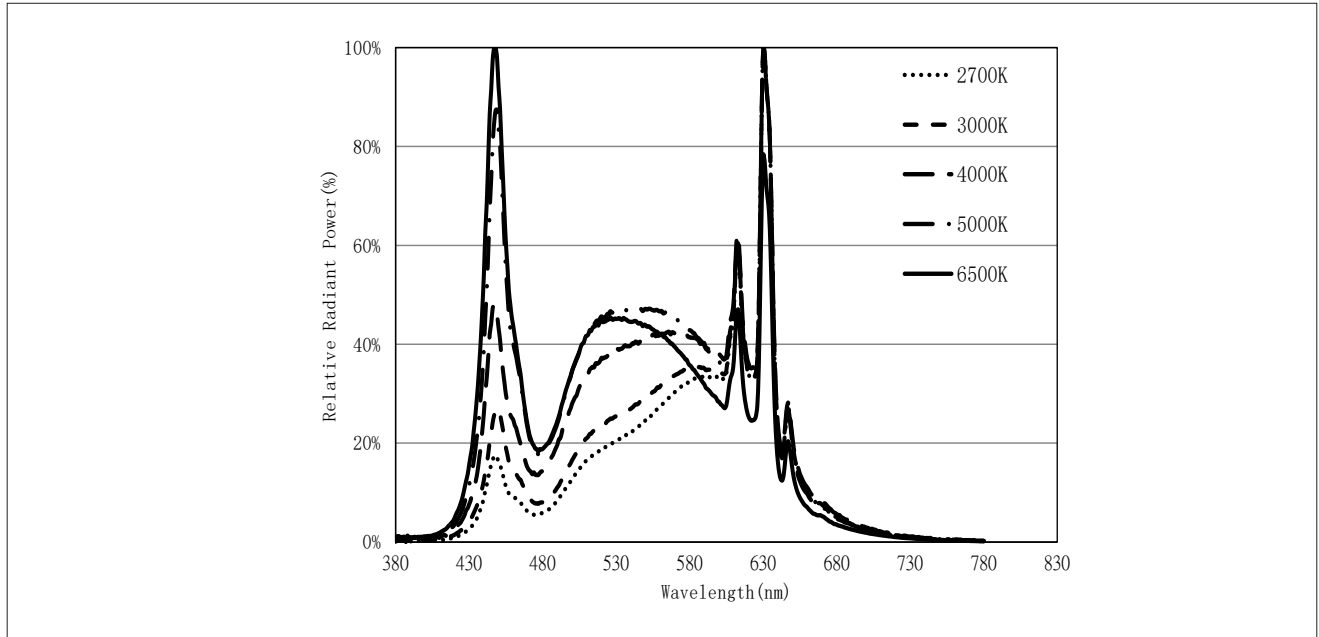

Notes for Figure 9:

1. Color spectra measured at nominal current for  $T_{sp} = 25^{\circ}\text{C}$
2. Color spectra shown for 90 CRI products.



# Mechanical Dimensions

Figure 10: Drawing for SMD 2835

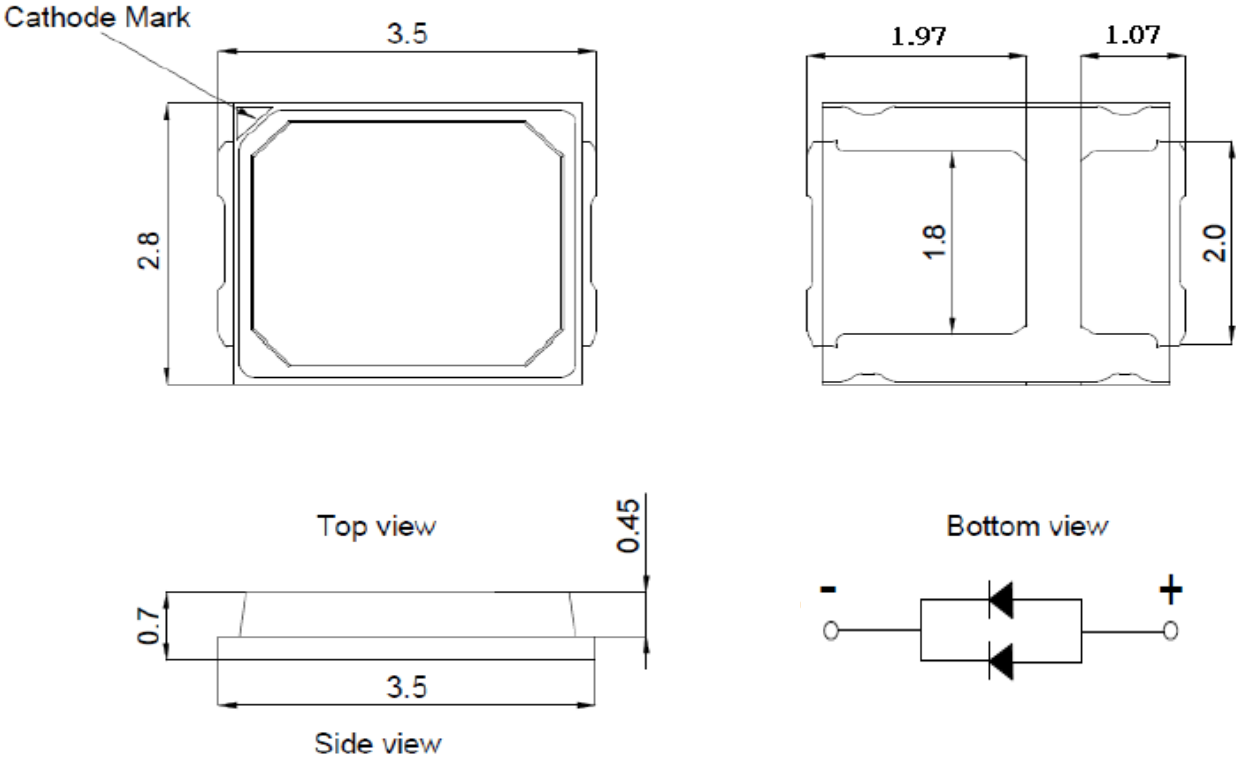

- Notes for Figure 10:
1. Drawings are not to scale.
  2. Drawing dimensions are in millimeters.
  3. Unless otherwise specified, tolerances are  $\pm 0.10\text{mm}$ .

## Recommended PCB Soldering Pad Pattern

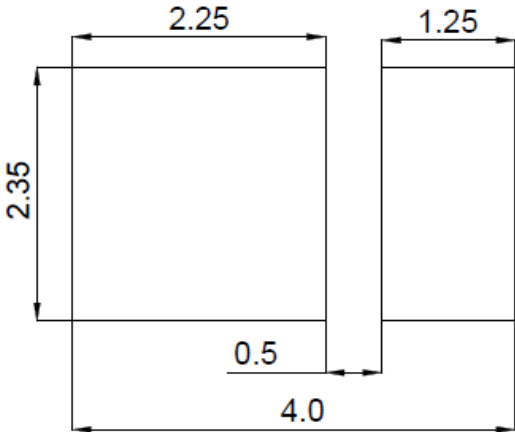

# Reliability

**Table 9: Reliability Test Items and Conditions**

| No. | Items                               | Reference Standard | Test Conditions   | Test Current | Test Duration | Units Failed/Tested |
|-----|-------------------------------------|--------------------|---|--------------|---------------|---------------------|
| 1   | Moisture/Reflow Sensitivity         | J-STD-020E         | $T_{\text{slid}} = 260^{\circ}\text{C}$ , 10sec.<br>Precondition: $60^{\circ}\text{C}$ , 60%RH, 168hr   | -            | 3 reflows     | 0/20                |
| 2   | Low Temperature Storage             | JESD22-A119        | $T_{\text{a}} = -40^{\circ}\text{C}$  | -            | 1000 hours    | 0/20                |
| 3   | High Temperature Storage            | JESD22-A103D       | $T_{\text{a}} = 105^{\circ}\text{C}$  | -            | 1000 hours    | 0/20                |
| 4   | Low Temperature Operating Life      | JESD22-A108D       | $T_{\text{a}} = -40^{\circ}\text{C}$  | 65mA         | 1000 hours    | 0/20                |
| 5   | Temperature Humidity Operating Life | JESD22-A101C       | $T_{\text{sp}} = 85^{\circ}\text{C}$ , RH=85%   | 65mA         | 1000 hours    | 0/20                |
| 6   | High Temperature Operating Life     | JESD22-A108D       | $T_{\text{sp}} = 85^{\circ}\text{C}$  | 180mA        | 1000 hours    | 0/20                |
| 7   | Power switching                     | IEC62717:2014      | $T_{\text{sp}} = 85^{\circ}\text{C}$<br>30 sec on, 30 sec off   | 180mA        | 30000 cycles  | 0/20                |
| 8   | Thermal Shock                       | JESD22-A106B       | $T_{\text{a}} = -40^{\circ}\text{C} \sim 105^{\circ}\text{C}$ ;<br>Dwell : 15min; Transfer: 10sec   | -            | 200 cycles    | 0/20                |
| 9   | Temperature Cycle                   | JESD22-A104E       | $T_{\text{a}} = -40^{\circ}\text{C} \sim 100^{\circ}\text{C}$ ;<br>Dwell at extreme temperature: 15min;<br>Ramp rate < $105^{\circ}\text{C}/\text{min}$ | -            | 200 cycles    | 0/20                |
| 10  | Electrostatic Discharge             | JS-001-2012        | HBM, 2kV, 15k $\Omega$ , 100pF.<br>Alternately positive or negative   | -            | -             | 0/20                |

## Passing Criteria

| Item                     | Symbol | Test Condition | Passing Criteria      |
|--------------------------|--------|----------------|-----------------------|
| Forward Voltage          | Vf     | 65mA           | $\Delta V_f < 10\%$   |
| Luminous Flux            | Fv     | 65mA           | $\Delta F_v < 30\%$   |
| Chromaticity Coordinates | (x, y) | 65mA           | $\Delta u'v' < 0.007$ |

Notes for Table 9:

1. Measurements are performed after allowing the LEDs to return to room temperature

2.  $T_{\text{slid}}$  : reflow soldering temperature;  $T_{\text{a}}$  : ambient temperature

# Reflow Characteristics

Figure 11 : Reflow Profile

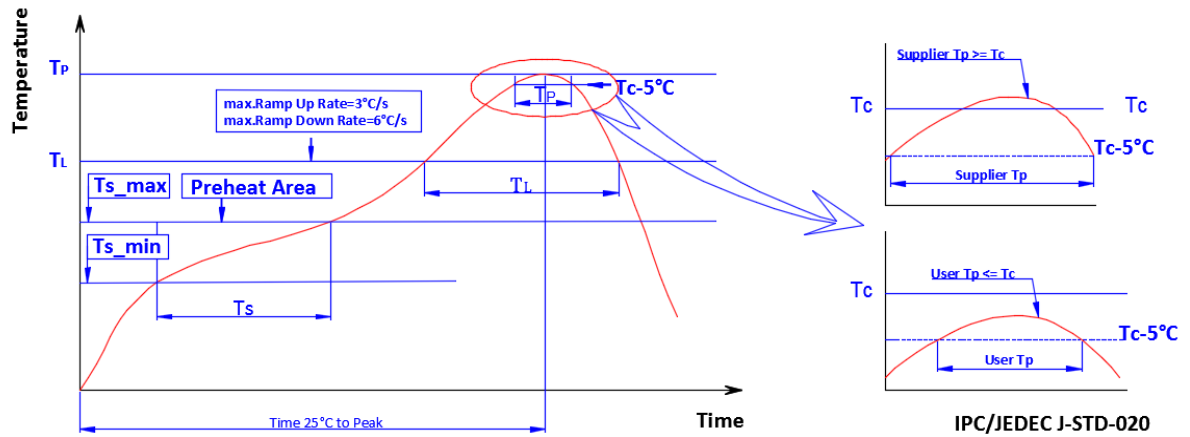

| Profile Feature   | Lead Free Assembly            |
|---|-------------------------------|
| Temperature Min. ( $T_{s\_min}$ )   | $160^\circ\text{C}$           |
| Temperature Max. ( $T_{s\_max}$ )   | $205^\circ\text{C}$           |
| Time (ts) from $T_{s\_min}$ to $T_{s\_max}$   | 60-150 seconds                |
| Ramp-Up Rate (TL to $T_p$ )   | $3^\circ\text{C/second}$      |
| Liquidus Temperature (TL)   | $220^\circ\text{C}$           |
| Time (TL) Maintained Above TL   | 60-150 seconds                |
| Peak Temp( $T_p$ )  | $260^\circ\text{C max.}$      |
| Time ( $T_p$ ) Within $5^\circ\text{C}$ of the Specified Classification Temperature ( $T_c$ ) | 25 seconds max.               |
| Ramp-Down Rate ( $T_p$ to TL)   | $5^\circ\text{C/second max.}$ |
| Time $25^\circ\text{C}$ to Peak Temperature   | 10 minutes max.               |

# Packaging

**Figure 12: Emitter Reel Drawings**

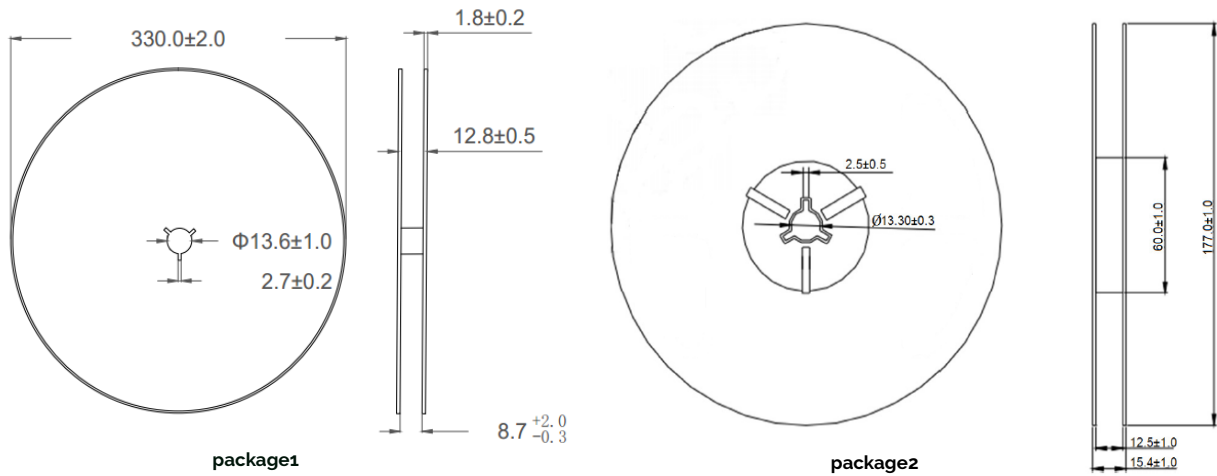

Note for Figure 12:

1. Drawings are not to scale. Drawing dimensions are in millimeters.

**Figure 13: Emitter Tape Drawings**

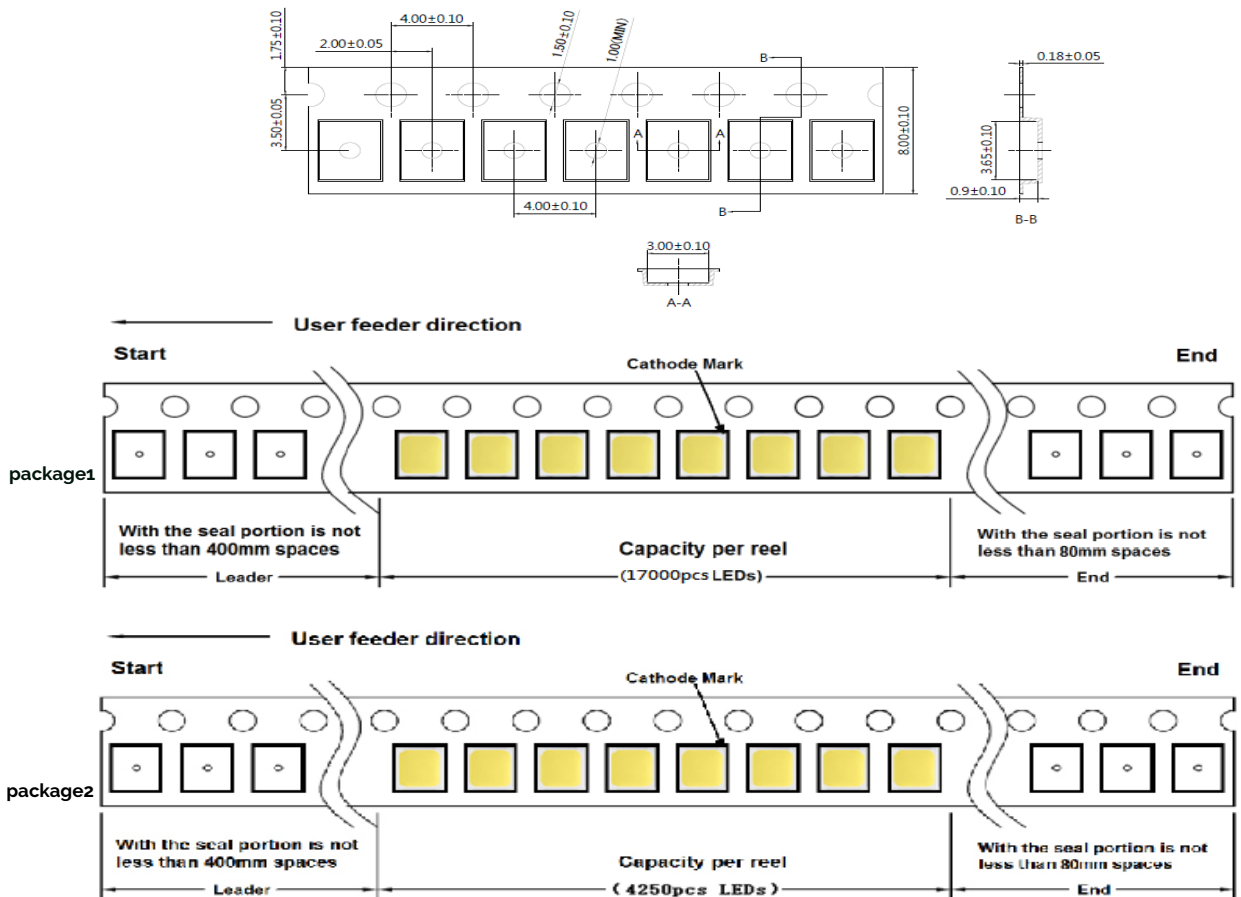

Note for Figure 13:

1. Drawings are not to scale. Drawing dimensions are in millimeters.

# Packaging

Figure 14: Emitter Reel Packaging Drawings

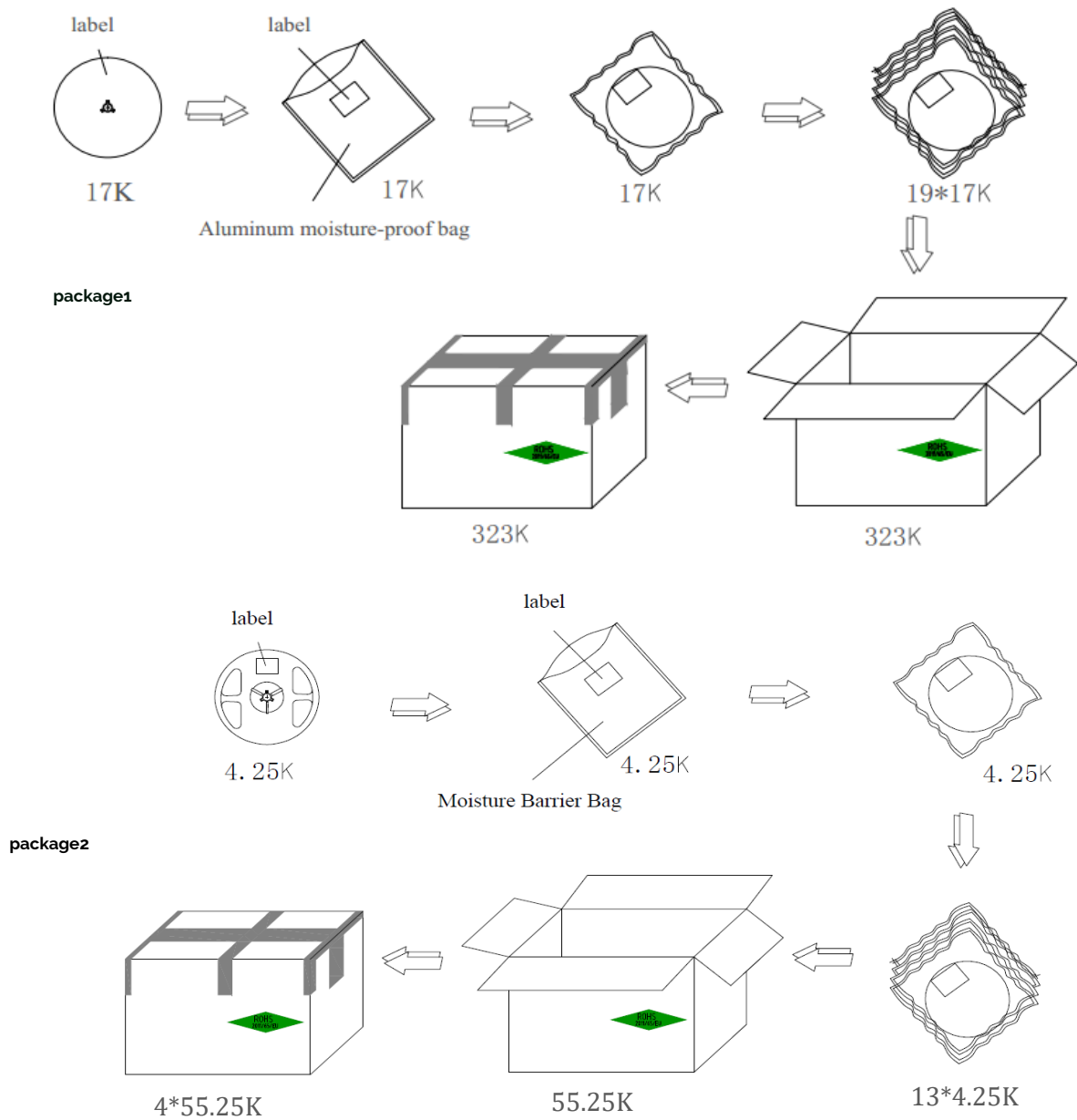

Note for Figure 14:  
1. Drawings are not to scale.

# Design Resources

Please contact your Bridgelux sales representative for assistance.

## Precautions

### **CAUTION: CHEMICAL EXPOSURE HAZARD**

Exposure to some chemicals commonly used in luminaire manufacturing and assembly can cause damage to the LED emitter. Please consult Bridgelux Application Note AN51 for additional information.

### **CAUTION: EYE SAFETY**

Eye safety classification for the use of Bridgelux SMD LED emitter is in accordance with IEC specification EN62471: Photobiological Safety of Lamps and Lamp Systems. SMD LED emitters are classified as Risk Group 1 when operated at or below the maximum Test current. Please use appropriate precautions. It is important that employees working with LEDs are trained to use them safely.

### **CAUTION: RISK OF BURN**

Do not touch the SMD LED emitter during operation. Allow the emitter to cool for a sufficient period of time before handling. The SMD LED emitter may reach elevated temperatures such that could burn skin when touched.

## CAUTION

### **CONTACT WITH LIGHT EMITTING SURFACE (LES)**

Avoid any contact with the LES. Do not touch the LES of the emitter or apply stress to the LES (yellow phosphor resin area). Contact may cause damage to the emitter

Optics and reflectors must not be mounted in contact with the LES (yellow phosphor resin area).

## Disclaimers

### **MINOR PRODUCT CHANGE POLICY**

The rigorous qualification testing on products offered by Bridgelux provides performance assurance. Slight cosmetic changes that do not affect form, fit, or function may occur as Bridgelux continues product optimization.

### **STANDARD TEST CONDITIONS**

Unless otherwise stated, LED emitter testing is performed at the nominal Test current.

# About Bridgelux: Bridging Light and Life™

At Bridgelux, we help companies, industries and people experience the power and possibility of light. Since 2002, we've designed LED solutions that are high performing, energy efficient, cost effective and easy to integrate. Our focus is on light's impact on human behavior, delivering products that create better environments, experiences and returns—both experiential and financial. And our patented technology drives new platforms for commercial and industrial luminaires.

**For more information about the company, please visit**  
**bridgelux.com**  
**twitter.com/Bridgelux**  
**facebook.com/Bridgelux**  
**youtube.com/user/Bridgelux**  
**WeChat ID: BridgeluxInChina**  
**[https://www.linkedin.com/company/bridgelux-inc-\\_2](https://www.linkedin.com/company/bridgelux-inc-_2)**



46410 Fremont Boulevard  
Fremont, CA 94538 USA  
Tel (925) 583-8400  
Fax (925) 583-8401  
**[www.bridgelux.com](http://www.bridgelux.com)**

© 2022 Bridgelux, Inc. All rights reserved 2022. Product specifications are subject to change without notice. Bridgelux and the Bridgelux stylized logo design are registered trademarks of Bridgelux, Inc. All other trademarks are the property of their respective owners.