

Bridgelux® Gen 7 Vero® 29 Array

Product Data Sheet DS93



Introduction

Vero® Series

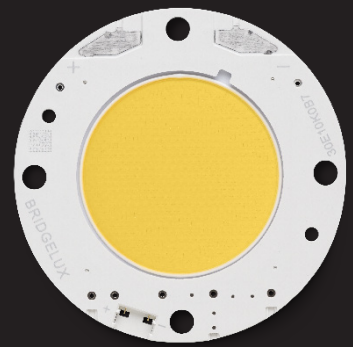

Vero® Series is a revolutionary advancement in chip on board (COB) light source technology and innovation. Vero LED light sources simplify luminaire design and manufacturing processes. Vero Chip on Board (COB) LED arrays are available in four LES configurations, engineered to enable new degrees of flexibility and reliability over a broad range of electrical currents. Vero arrays deliver increased lumen density to enable improved beam control and precision lighting with 2 and 3 SDCM color control standard for clean and consistent uniform lighting.

Vero products include an onboard connector port that enables a solder-free electrical interconnect, and simple mounting features for plug-and-play installation.

Bridgelux Décor Series™ is our state-of-the-art color line designed specifically for premium applications, producing unmatched LED light quality with brilliant color-rendering options and pleasing lighting palettes. Bridgelux Décor Series color points are available on Vero® SE Series, Vero® Series, V Series™ and V Series™ HD.

Décor Series™ Class A is based on human response testing, providing color points with a combined GAI and CRI metric.

Décor Series™ Ultra products provide a high CRI of 97 and typical R₉ value of 98, which emphasizes the reds and color tones to which the human eye is most receptive - perfect for the most luxurious retail shops and world renowned museums. Décor Series Ultra is designed as a replacement for halogen lamps.

Décor Series™ Food products offer color points developed to address the unique requirements of the food, grocery, and restaurant industries. Highlighting the distinctive colors and nuanced patterns found in meats and breads, the Décor Series Food products are a must have for any butcher counter or bakery.

Décor Series™ Entertainment products provide color points developed specifically for the healthcare and entertainment industries. The 5600K cool white color point combined with a CRI of 90 or 97 provides the bright white required by these industries.

Décor Series™ Street and Landmark is designed to be a direct replacement for high pressure sodium lamps.

Features

- Efficacy of 170 lm/W typical
- Lumen output performance ranges from 3,850 to 38,400 lumens
- Broad range of CCT options from 1750K to 6500K
- CRI options include minimum 65, 70, 80, and 90, 2 and 3 SDCM color control for 2700K-4000K CCT
- Reliable operation at up to 2X nominal drive current
- Radial die pattern and improved lumen density
- Thermally isolated solder pads
- Onboard connector port
- Top side part number markings
- V_f bin code backside marking

Benefits

- Broad application coverage for interior and exterior lighting
- Flexibility for application driven lighting design requirements
- High quality true color reproduction
- Uniform consistent white light
- Flexibility in design optimization
- Enhanced ease of use and assembly
- Solderless connectivity enables plug & play installation and field upgradability
- Improved inventory management and quality control



Contents

Product Feature Map	2
Product Nomenclature	2
Product Selection Guide	3
European Product Registry for Energy Labeling	10
Performance at Commonly Used Drive Currents	13
Electrical Characteristics	23
Eye Safety	24
Absolute Maximum Ratings	25
Performance Curves	26
Typical Radiation Pattern	30
Typical Color Spectrum	31
Mechanical Dimensions	32
Color Binning Information	33
Packaging and Labeling	34
Design Resources	36
Precautions	36
Disclaimers	36
About Bridgelux	37

Product Selection Guide

The following product configurations are available:

Table 1: Selection Guide, Pulsed Measurement Data ($T_j = T_c = 25^\circ\text{C}$)

Part Number	Nominal CCT ¹ (K)	CRI ²	Nominal Drive Current ³ (mA)	Typical Pulsed Flux ^{4,5,6} $T_c = 25^\circ\text{C}$ (lm)	Minimum Pulsed Flux ^{6,7} $T_c = 25^\circ\text{C}$ (lm)	Typical V_f (V)	Typical Power (W)	Typical Efficacy (lm/W)
BXRC-17E10K0-B-7x	1750	80	1800	8611	7750	52.0	93.6	92
BXRC-17E10K0-C-7x	1750	80	1710	10918	9826	69.4	118.7	92
BXRC-17E10K0-D-7x	1750	80	2100	7264	6538	37.6	79.0	92
BXRC-20B10K1-C-7x	2000	65	1710	18632	16769	69.4	118.7	157
BXRC-20B10K1-D-7x	2000	65	2100	12397	11157	37.6	79.0	157
BXRC-25E10K0-B-7x	2500	80	1800	14321	12889	52.0	93.6	153
BXRC-25E10K0-C-7x	2500	80	1710	18157	16341	69.4	118.7	153
BXRC-25E10K0-D-7x	2500	80	2100	12081	10873	37.6	79.0	153
BXRC-27E10K0-B-7x	2700	80	1800	14976	13478	52.0	93.6	160
BXRC-27E10K0-C-7x	2700	80	1710	18988	17089	69.4	118.7	160
BXRC-27E10K0-D-7x	2700	80	2100	12634	11370	37.6	79.0	160
BXRC-27G1KH0-B-7x	2700	90	1800	12823	11541	52.0	93.6	137
BXRC-27G1KH0-C-7x	2700	90	1710	16258	14633	69.4	118.7	137
BXRC-27G1KH0-D-7x	2700	90	2100	10818	9736	37.6	79.0	137
BXRC-27G10K0-B-7x	2700	90	1800	12355	11120	52.0	93.6	132
BXRC-27G10K0-C-7x	2700	90	1710	15665	14098	69.4	118.7	132
BXRC-27G10K0-D-7x	2700	90	2100	10423	9380	37.6	79.0	132
BXRC-27H10K0-D-7x	2700	97	2100	9243	8319	37.6	79.0	117
BXRC-30C10K1-B-7x	3000	70	1800	16661	14995	52.0	93.6	178
BXRC-30C10K1-C-7x	3000	70	1710	21124	19012	69.4	118.7	178
BXRC-30C10K1-D-7x	3000	70	2100	14055	12649	37.6	79.0	178
BXRC-30E10K0-B-7x ¹⁰	3000	80	1800	15912	14321	52.0	93.6	170
BXRC-30E10K0-C-7x ¹⁰	3000	80	1710	20175	18157	69.4	118.7	170
BXRC-30E10K0-D-7x ¹⁰	3000	80	2100	13423	12081	37.6	79.0	170
BXRC-30G1KH0-B-7x	3000	90	1800	13478	12131	52.0	93.6	144
BXRC-30G1KH0-C-7x	3000	90	1710	17089	15380	69.4	118.7	144
BXRC-30G1KH0-D-7x	3000	90	2100	11370	10233	37.6	79.0	144
BXRC-30G10K0-B-7x	3000	90	1800	12917	11625	52.0	93.6	138
BXRC-30G10K0-C-7x	3000	90	1710	16377	14739	69.4	118.7	138
BXRC-30G10K0-D-7x	3000	90	2100	10896	9807	37.6	79.0	138
BXRC-30H10K0-D-7x	3000	97	2100	9870	8883	37.6	79.0	125
BXRC-30A10K1-B-7x ^{8,9}	3000	93	1800	11606	10446	52.0	93.6	124
BXRC-30A10K1-C-7x ^{8,9}	3000	93	1710	14716	13244	69.4	118.7	124
BXRC-30A10K1-D-7x ^{8,9}	3000	93	2100	9791	8812	37.6	79.0	124

Notes for Table 1:

- Nominal CCT as defined by ANSI C78.377-2011. Products with a CCT of 5000K-6500K are hot targeted to $T_c = 85^\circ\text{C}$.
- CRI values are typical for Décor Series Class A, Décor Series Street and Landmark and Décor Series Ultra products. CRI values are minimums for all other products. Minimum Rg value for 80 CRI products is 0, the minimum Rg values for 90 CRI products is 50, the minimum Rg values for 97 CRI products is 93. Bridgelux maintains a ± 3 tolerance on CRI and Rg values.
- Drive current is referred to as nominal drive current.
- Products tested under pulsed condition (10ms pulse width) at nominal test current where T_j (junction temperature) = T_c (case temperature) = 25°C .
- Typical performance values are provided as a reference only and are not a guarantee of performance.
- Bridgelux maintains a $\pm 7\%$ tolerance on flux measurements.
- Minimum flux values at the nominal test current are guaranteed by 100% test.
- Nominal CCT is defined by the Lighting Research Center's Class A definition. The center of the Class A color bin is on the corresponding isothermal line.
- GAI value is 80. To help ensure optimal fixture level performance, GAI is measured at the fixture level, on axis, at a case temperature of 70°C . GAI may vary depending on fixture design and performance.
- SKUs can meet DLC premium (Outdoor Mid Output) requirements under certain system level conditions.

Product Selection Guide

Table 1: Selection Guide, Pulsed Measurement Data ($T_j = T_c = 25^\circ\text{C}$) (continued)

Part Number	Nominal CCT ¹ (K)	CRI ²	Nominal Drive Current ³ (mA)	Typical Pulsed Flux ^{4,5,6} $T_c = 25^\circ\text{C}$ (lm)	Minimum Pulsed Flux ^{6,7} $T_c = 25^\circ\text{C}$ (lm)	Typical V_f (V)	Typical Power (W)	Typical Efficacy (lm/W)
BXRC-35E10K0-B-7x ¹⁰	3500	80	1800	16286	14658	52.0	93.6	174
BXRC-35E10K0-C-7x ¹⁰	3500	80	1710	20649	18584	69.4	118.7	174
BXRC-35E10K0-D-7x ¹⁰	3500	80	2100	13739	12365	37.6	79.0	174
BXRC-35G10K0-B-7x	3500	90	1800	13385	12046	52.0	93.6	143
BXRC-35G10K0-C-7x	3500	90	1710	16970	15273	69.4	118.7	143
BXRC-35G10K0-D-7x	3500	90	2100	11291	10162	37.6	79.0	143
BXRC-35A10K1-B-7x ^{8,9}	3500	93	1800	12355	11120	52.0	93.6	132
BXRC-35A10K1-C-7x ^{8,9}	3500	93	1710	15665	14098	69.4	118.7	132
BXRC-35A10K1-D-7x ^{8,9}	3500	93	2100	10423	9380	37.6	79.0	132
BXRC-40C10K1-B-7x	4000	70	1800	17129	15416	52.0	93.6	183
BXRC-40C10K1-C-7x	4000	70	1710	21717	19546	69.4	118.7	183
BXRC-40C10K1-D-7x	4000	70	2100	14450	13005	37.6	79.0	183
BXRC-40E10K0-B-7x ¹⁰	4000	80	1800	16380	14742	52.0	93.6	175
BXRC-40E10K0-C-7x ¹⁰	4000	80	1710	20768	18691	69.4	118.7	175
BXRC-40E10K0-D-7x ¹⁰	4000	80	2100	13818	12436	37.6	79.0	175
BXRC-40G10K0-B-7x	4000	90	1800	13666	12299	52.0	93.6	146
BXRC-40G10K0-C-7x	4000	90	1710	17326	15594	69.4	118.7	146
BXRC-40G10K0-D-7x	4000	90	2100	11528	10375	37.6	79.0	146
BXRC-40H10K0-D-7x	4000	97	2100	10423	9380	37.6	79.0	132
BXRC-40A10K1-B-73 ^{8,9}	4000	93	1800	13385	12046	52.0	93.6	143
BXRC-40A10K1-C-73 ^{8,9}	4000	93	1710	16970	15273	69.4	118.7	143
BXRC-40A10K1-D-73 ^{8,9}	4000	93	2100	11291	10162	37.6	79.0	143
BXRC-50C10K1-B-7x ¹⁰	5000	70	1800	17222	15500	52.0	93.6	184
BXRC-50C10K1-C-7x ¹⁰	5000	70	1710	21836	19652	69.4	118.7	184
BXRC-50C10K1-D-7x ¹⁰	5000	70	2100	14529	13076	37.6	79.0	184
BXRC-50E10K1-B-7x	5000	80	1800	16567	14910	52.0	93.6	177
BXRC-50E10K1-C-7x	5000	80	1710	21005	18905	69.4	118.7	177
BXRC-50E10K1-D-7x	5000	80	2100	13976	12578	37.6	79.0	177
BXRC-50G10K1-B-7x	5000	90	1800	14321	12889	52.0	93.6	153
BXRC-50G10K1-C-7x	5000	90	1710	18157	16341	69.4	118.7	153
BXRC-50G10K1-D-7x	5000	90	2100	12081	10873	37.6	79.0	153
BXRC-56G10K0-B-7x	5600	90	1800	14414	12973	52.0	93.6	154
BXRC-56G10K0-C-7x	5600	90	1710	18276	16448	69.4	118.7	154
BXRC-56G10K0-D-7x	5600	90	2100	12160	10944	37.6	79.0	154
BXRC-56H10K1-D-7x	5600	97	2100	10975	9878	37.6	79.0	139

Notes for Table 1:

- Nominal CCT as defined by ANSI C78.377-2011. Products with a CCT of 5000K-6500K are hot targeted to $T_c = 85^\circ\text{C}$.
- CRI values are typical for Décor Series Class A, Décor Series Street and Landmark and Décor Series Ultra products. CRI values are minimums for all other products. Minimum Rg value for 80 CRI products is 0, the minimum Rg values for 90 CRI products is 50, the minimum Rg value for 97 CRI products is 93. Bridgelux maintains a ± 3 tolerance on CRI and Rg values.
- Drive current is referred to as nominal drive current.
- Products tested under pulsed condition (10ms pulse width) at nominal test current where T_j (junction temperature) - T_c (case temperature) = 25°C .
- Typical performance values are provided as a reference only and are not a guarantee of performance.
- Bridgelux maintains a $\pm 7\%$ tolerance on flux measurements.
- Minimum flux values at the nominal test current are guaranteed by 100% test.
- Nominal CCT is defined by the Lighting Research Center's Class A definition. The center of the Class A color bin is on the corresponding isothermal line.
- GAI value is 80. To help ensure optimal fixture level performance, GAI is measured at the fixture level, on axis, at a case temperature of 70°C . GAI may vary depending on fixture design and performance.
- SKUs can meet DLC premium (Outdoor Mid Output) requirements under certain system level conditions.

Product Selection Guide

Table 1: Selection Guide, Pulsed Measurement Data ($T_j = T_c = 25^\circ\text{C}$) (continued)

Part Number	Nominal CCT ¹ (K)	CRI ²	Nominal Drive Current ³ (mA)	Typical Pulsed Flux ^{4,5,6} $T_c = 25^\circ\text{C}$ (lm)	Minimum Pulsed Flux ^{6,7} $T_c = 25^\circ\text{C}$ (lm)	Typical V_f (V)	Typical Power (W)	Typical Efficacy (lm/W)
BXRC-57C10K1-B-7x ¹⁰	5700	70	1800	16754	15079	52.0	93.6	179
BXRC-57C10K1-C-7x ¹⁰	5700	70	1710	21243	19118	69.4	118.7	179
BXRC-57C10K1-D-7x ¹⁰	5700	70	2100	14134	12720	37.6	79.0	179
BXRC-57E10K1-B-7x ¹⁰	5700	80	1800	15912	14321	52.0	93.6	170
BXRC-57E10K1-C-7x ¹⁰	5700	80	1710	20175	18157	69.4	118.7	170
BXRC-57E10K1-D-7x ¹⁰	5700	80	2100	13423	12081	37.6	79.0	170
BXRC-65C10K1-B-7x ¹⁰	6500	70	1800	16754	15079	52.0	93.6	179
BXRC-65C10K1-C-7x ¹⁰	6500	70	1710	21243	19118	69.4	118.7	179
BXRC-65C10K1-D-7x ¹⁰	6500	70	2100	14134	12720	37.6	79.0	179
BXRC-65E10K1-B-7x ¹⁰	6500	80	1800	16099	14489	52.0	93.6	172
BXRC-65E10K1-C-7x ¹⁰	6500	80	1710	20412	18371	69.4	118.7	172
BXRC-65E10K1-D-7x ¹⁰	6500	80	2100	13581	12223	37.6	79.0	172

Notes for Table 1:

- Nominal CCT as defined by ANSI C78.377-2011. Products with a CCT of 5000K-6500K are hot targeted to $T_c = 85^\circ\text{C}$.
- CRI values are typical for Décor Series Class A, Décor Series Street and Landmark and Décor Series Ultra products. CRI values are minimums for all other products. Minimum Rg value for 80 CRI products is 0, the minimum Rg values for 90 CRI products is 50, the minimum Rg value for 97 CRI products is 93. Bridgelux maintains a ± 3 tolerance on CRI and Rg values.
- Drive current is referred to as nominal drive current.
- Products tested under pulsed condition (10ms pulse width) at nominal test current where T_j (junction temperature) = T_c (case temperature) = 25°C .
- Typical performance values are provided as a reference only and are not a guarantee of performance.
- Bridgelux maintains a $\pm 7\%$ tolerance on flux measurements.
- Minimum flux values at the nominal test current are guaranteed by 100% test.
- Nominal CCT is defined by the Lighting Research Center's Class A definition. The center of the Class A color bin is on the corresponding isothermal line.
- GAI value is 80. To help ensure optimal fixture level performance, GAI is measured at the fixture level, on axis, at a case temperature of 70°C . GAI may vary depending on fixture design and performance.
- SKUs can meet DLC premium (Outdoor Mid Output) requirements under certain system level conditions.

Product Selection Guide

Table 2: Selection Guide, Stabilized DC Performance ($T_c = 70^\circ\text{C}$) ^{7,8}

Part Number	Nominal CCT ¹ (K)	GAI ²	CRI ³	Nominal Drive Current ⁴ (mA)	Typical DC Flux ^{5,6} $T_c = 70^\circ\text{C}$ (lm)	Minimum DC Flux ^{6,9} $T_c = 70^\circ\text{C}$ (lm)	Typical V_f (V)	Typical Power (W)	Typical Efficacy (lm/W)
BXRC-30A10K1-B-7x	3000	80	93	1800	10794	9715	50.9	91.6	118
BXRC-30A10K1-C-7x	3000	80	93	1710	13685	12317	67.9	116.1	118
BXRC-30A10K1-D-7x	3000	80	93	2100	9106	8195	36.8	77.3	118
BXRC-35A10K1-B-7x	3500	80	93	1800	11490	10341	50.9	91.6	125
BXRC-35A10K1-C-7x	3500	80	93	1710	14568	13112	67.9	116.1	126
BXRC-35A10K1-D-7x	3500	80	93	2100	9693	8724	36.8	77.3	125
BXRC-40A10K1-B-7x	4000	80	93	1800	12448	11203	50.9	91.6	136
BXRC-40A10K1-C-7x	4000	80	93	1710	15782	14204	67.9	116.1	136
BXRC-40A10K1-D-7x	4000	80	93	2100	10501	9451	36.8	77.3	136

Notes for Table 2:

- Nominal CCT is defined by the Lighting Research Center's Class A definition. The center of the Class A color bin is on the corresponding isothermal line.
- To help ensure optimal fixture level performance, GAI is measured at the fixture level, on axis, at a case temperature of 70°C . GAI may vary depending on fixture design and performance.
- CRI Values are specified as typical.
- Drive current is referred to as nominal drive current.
- Typical performance values are provided as a reference only and are not a guarantee of performance.
- Bridgelux maintains a $\pm 7\%$ tolerance on flux measurements.
- Typical stabilized DC performance values are provided as reference only and are not a guarantee of performance.
- Typical performance is estimated based on operation under DC (direct current) with LED array mounted onto a heat sink with thermal interface material and the case temperature maintained at specified temperature. Based on Bridgelux test setup, values may vary depending on the thermal design of the luminaire and/or the exposed environment to which the product is subjected.
- Minimum flux values at elevated temperatures are provided for reference only and are not guaranteed by 100% production testing. Based on Bridgelux test setup, values may vary depending on the thermal design of the luminaire and/or the exposed environment to which the product is subjected.

Product Selection Guide

x

Table 3: Selection Guide, Stabilized DC Performance ($T_c = 85^\circ\text{C}$)⁴⁵

Part Number	Nominal CCT ¹ (K)	CRI ²	Nominal Drive Current ³ (mA)	Typical DC Flux ^{4,5} $T_c = 85^\circ\text{C}$ (lm)	Minimum DC Flux ⁶ $T_c = 85^\circ\text{C}$ (lm)	Typical V_f (V)	Typical Power (W)	Typical Efficacy (lm/W)
BXRC-17E10K0-B-7x	1750	80	1800	7750	6975	50.7	91.2	85
BXRC-17E10K0-C-7x	1750	80	1710	9826	8844	68.1	116.4	84
BXRC-17E10K0-D-7x	1750	80	2100	6538	5884	36.6	76.8	85
BXRC-20B10K0-C-73	2000	65	1710	16769	15092	68.1	116.4	144
BXRC-20B10K0-D-7x	2000	65	2100	11157	10041	36.6	76.8	145
BXRC-25E10K0-B-7x	2500	80	1800	12889	11600	50.7	91.2	141
BXRC-25E10K0-C-7x	2500	80	1710	16341	14707	68.1	116.4	140
BXRC-25E10K0-D-7x	2500	80	2100	10873	9786	36.6	76.8	142
BXRC-27E10K0-B-7x	2700	80	1800	13478	12131	50.7	91.2	148
BXRC-27E10K0-C-7x	2700	80	1710	17089	15380	68.1	116.4	147
BXRC-27E10K0-D-7x	2700	80	2100	11370	10233	36.6	76.8	148
BXRC-27G1KH0-B-7x	2700	90	1800	11541	10387	51.0	91.7	126
BXRC-27G1KH0-C-7x	2700	90	1710	14633	13169	68.4	116.9	125
BXRC-27G1KH0-D-7x	2700	90	2100	9736	8762	36.6	76.8	127
BXRC-27G10K0-B-7x	2700	90	1800	11120	10008	51.0	91.7	121
BXRC-27G10K0-C-7x	2700	90	1710	14098	12689	68.4	116.9	121
BXRC-27G10K0-D-7x	2700	90	2100	9380	8442	36.6	76.8	122
BXRC-27H10K0-D-7x	2700	97	2100	8319	7487	36.6	76.8	108
BXRC-30C10K1-B-7x	3000	70	1800	14995	13495	51.0	91.7	163
BXRC-30C10K1-C-7x	3000	70	1710	19012	17110	68.4	116.9	163
BXRC-30C10K1-D-7x	3000	70	2100	12649	11384	36.6	76.8	165
BXRC-30E10K0-B-7x	3000	80	1800	14321	12889	51.0	91.7	156
BXRC-30E10K0-C-7x	3000	80	1710	18157	16341	68.4	116.9	155
BXRC-30E10K0-D-7x	3000	80	2100	12081	10873	36.6	76.8	157
BXRC-30G1KH0-B-7x	3000	90	1800	12131	10918	51.0	91.7	132
BXRC-30G1KH0-C-7x	3000	90	1710	15380	13842	68.4	116.9	132
BXRC-30G1KH0-D-7x	3000	90	2100	10233	9210	36.6	76.8	133
BXRC-30G10K0-B-7x	3000	90	1800	11625	10463	50.7	91.2	127
BXRC-30G10K0-C-7x	3000	90	1710	14739	13265	68.1	116.4	127
BXRC-30G10K0-D-7x	3000	90	2100	9807	8826	36.6	76.8	128
BXRC-30H10K0-D-7x	3000	97	2100	8883	7995	36.6	76.9	116
BXRC-30A10K1-B-7x ^{7,8}	3000	93	1800	10446	9401	50.7	91.2	115
BXRC-30A10K1-C-7x ^{7,8}	3000	93	1710	13244	11920	68.1	116.4	114
BXRC-30A10K1-D-7x ^{7,8}	3000	93	2100	8812	7931	36.6	76.8	115

Notes for Table 3:

- Nominal CCT as defined by ANSI C78.377-2011. Products with a CCT of 5000K-6500K are hot targeted to $T_c = 85^\circ\text{C}$.
- All CRI values are measured at $T_c = T_a = 25^\circ\text{C}$. CRI values are typical for Décor Series Class A, Décor Series Street and Landmark and Décor Series Ultra products. CRI values are minimums for all other products. Minimum R_g value for 80 CRI products is 0, the minimum R_g values for 90 CRI products is 50, the minimum R_g values for 97 CRI products is 93. Bridgelux maintains a ± 3 tolerance on CRI and R_g values.
- Drive current is referred to as nominal drive current.
- Typical stabilized DC performance values are provided as reference only and are not a guarantee of performance.
- Typical performance is estimated based on operation under DC (direct current) with LED array mounted onto a heat sink with thermal interface material and the case temperature maintained at 85°C . Based on Bridgelux test setup, values may vary depending on the thermal design of the luminaire and/or the exposed environment to which the product is subjected.
- Minimum flux values at elevated temperatures are provided for reference only and are not guaranteed by 100% production testing. Based on Bridgelux test setup, values may vary depending on the thermal design of the luminaire and/or the exposed environment to which the product is subjected.
- Nominal CCT is defined by the Lighting Research Center's Class A definition. The center of the Class A color bin is on the corresponding isothermal line.
- GAI value is 80. To help ensure optimal fixture level performance, GAI is measured at the fixture level, on axis, at a case temperature of 70°C . GAI may vary depending on fixture design and performance.

Product Selection Guide

Table 3: Selection Guide, Stabilized DC Performance ($T_c = 85^\circ\text{C}$)⁴⁵ (continued)

Part Number	Nominal CCT ¹ (K)	CRI ²	Nominal Drive Current ³ (mA)	Typical DC Flux ^{4,5} $T_c = 85^\circ\text{C}$ (lm)	Minimum DC Flux ⁶ $T_c = 85^\circ\text{C}$ (lm)	Typical V_f (V)	Typical Power (W)	Typical Efficacy (lm/W)
BXRC-35E10K0-B-7X	3500	80	1800	14658	13192	50.7	91.2	161
BXRC-35E10K0-C-7X	3500	80	1710	18584	16726	68.1	116.4	160
BXRC-35E10K0-D-7X	3500	80	2100	12365	11129	36.6	76.8	161
BXRC-35G10K0-B-7X	3500	90	1800	12046	10842	50.7	91.2	132
BXRC-35G10K0-C-7X	3500	90	1710	15273	13746	68.1	116.4	131
BXRC-35G10K0-D-7X	3500	90	2100	10162	9146	36.6	76.8	132
BXRC-35A10K1-B-7X ^{7,8}	3500	93	1800	11120	10008	50.7	91.2	122
BXRC-35A10K1-C-7X ^{7,8}	3500	93	1710	14098	12689	68.1	116.4	121
BXRC-35A10K1-D-7X ^{7,8}	3500	93	2100	9380	8442	36.6	76.8	122
BXRC-40C10K1-B-7X	4000	70	1800	15416	13874	51.0	91.7	168
BXRC-40C10K1-C-7X	4000	70	1710	19546	17591	68.4	116.9	167
BXRC-40C10K1-D-7X	4000	70	2100	13005	11704	36.6	76.8	169
BXRC-40E10K0-B-7X	4000	80	1800	14742	13268	50.7	91.2	162
BXRC-40E10K0-C-7X	4000	80	1710	18691	16822	68.1	116.4	161
BXRC-40E10K0-D-7X	4000	80	2100	12436	11193	36.6	76.8	162
BXRC-40G10K0-B-7X	4000	90	1800	12299	11069	50.7	91.2	135
BXRC-40G10K0-C-7X	4000	90	1710	15594	14034	68.1	116.4	134
BXRC-40G10K0-D-7X	4000	90	2100	10375	9338	36.6	76.8	135
BXRC-40H10K0-D-7X	4000	97	2100	9380	8442	36.6	76.9	122
BXRC-40A10K1-B-7X ^{7,8}	4000	93	1800	12046	10842	50.7	91.2	132
BXRC-40A10K1-C-7X ^{7,8}	4000	93	1710	15273	13746	68.1	116.4	131
BXRC-40A10K1-D-7X ^{7,8}	4000	93	2100	10162	9146	36.6	76.8	132
BXRC-50C10K1-B-7X	5000	70	1800	15500	13950	50.7	91.2	170
BXRC-50C10K1-C-7X	5000	70	1710	19652	17687	68.1	116.4	169
BXRC-50C10K1-D-7X	5000	70	2100	13076	11768	36.6	76.8	170
BXRC-50E10K1-B-7X	5000	80	1800	14910	13419	50.7	91.2	163
BXRC-50E10K1-C-7X	5000	80	1710	18905	17014	68.1	116.4	162
BXRC-50E10K1-D-7X	5000	80	2100	12578	11320	36.6	76.8	164
BXRC-50G10K1-B-7X	5000	90	1800	12889	11600	50.7	91.2	141
BXRC-50G10K1-C-7X	5000	90	1710	16341	14707	68.1	116.4	140
BXRC-50G10K1-D-7X	5000	90	2100	10873	9786	36.6	76.8	142
BXRC-56G10K0-B-7X	5600	90	1800	12973	11676	50.7	91.2	142
BXRC-56G10K0-C-7X	5600	90	1710	16448	14803	68.1	116.4	141
BXRC-56G10K0-D-7X	5600	90	2100	10944	9849	36.6	76.8	143
BXRC-56H10K1-D-7X	5600	97	2100	9878	8890	36.6	76.9	129

Notes for Table 3:

- Nominal CCT as defined by ANSI C78.377-2011. Products with a CCT of 5000K-6500K are hot targeted to $T_c = 85^\circ\text{C}$.
- All CRI values are measured at $T_c = T_a = 25^\circ\text{C}$. CRI values are typical for Decor Series Class A, Decor Series Street and Landmark and Décor Series Ultra products. CRI values are minimums for all other products. Minimum R9 value for 80 CRI products is 0, the minimum R9 values for 90 CRI products is 50, the minimum R9 values for 97 CRI products is 93. Bridgelux maintains a ± 3 tolerance on CRI and R9 values.
- Drive current is referred to as nominal drive current.
- Typical stabilized DC performance values are provided as reference only and are not a guarantee of performance.
- Typical performance is estimated based on operation under DC (direct current) with LED array mounted onto a heat sink with thermal interface material and the case temperature maintained at 85°C . Based on Bridgelux test setup, values may vary depending on the thermal design of the luminaire and/or the exposed environment to which the product is subjected.
- Minimum flux values at elevated temperatures are provided for reference only and are not guaranteed by 100% production testing. Based on Bridgelux test setup, values may vary depending on the thermal design of the luminaire and/or the exposed environment to which the product is subjected.
- Nominal CCT is defined by the Lighting Research Center's Class A definition. The center of the Class A color bin is on the corresponding isothermal line.
- GAI value is 80. To help ensure optimal fixture level performance, GAI is measured at the fixture level, on axis, at a case temperature of 70°C . GAI may vary depending on fixture design and performance.

Product Selection Guide

Table 3: Selection Guide, Stabilized DC Performance ($T_c = 85^\circ\text{C}$) ^{4,5}(continued)

Part Number	Nominal CCT ¹ (K)	CRI ²	Nominal Drive Current ³ (mA)	Typical DC Flux ^{4,5} $T_c = 85^\circ\text{C}$ (lm)	Minimum DC Flux ⁶ $T_c = 85^\circ\text{C}$ (lm)	Typical V_f (V)	Typical Power (W)	Typical Efficacy (lm/W)
BXRC-57C10K1-B-7x	5700	70	1800	15079	13571	50.7	91.2	165
BXRC-57C10K1-C-7x	5700	70	1710	19118	17207	68.1	116.4	164
BXRC-57C10K1-D-7x	5700	70	2100	12720	11448	36.6	76.8	166
BXRC-57E10K1-B-7x	5700	80	1800	14321	12889	50.7	91.2	157
BXRC-57E10K1-C-7x	5700	80	1710	18157	16341	68.1	116.4	156
BXRC-57E10K1-D-7x	5700	80	2100	12081	10873	36.6	76.8	157
BXRC-65C10K1-B-7x	6500	70	1800	15079	13571	50.7	91.2	165
BXRC-65C10K1-C-7x	6500	70	1710	19118	17207	68.1	116.4	164
BXRC-65C10K1-D-7x	6500	70	2100	12720	11448	36.6	76.8	166
BXRC-65E10K1-B-7x	6500	80	1800	14489	13040	50.7	91.2	159
BXRC-65E10K1-C-7x	6500	80	1710	18371	16534	68.1	116.4	158
BXRC-65E10K1-D-7x	6500	80	2100	12223	11001	36.6	76.8	159

Notes for Table 3:

- Nominal CCT as defined by ANSI C78.377-2011. Products with a CCT of 5000K-6500K are hot targeted to $T_c = 85^\circ\text{C}$.
- All CRI values are measured at $T_j = T_c = 25^\circ\text{C}$. CRI values are typical for Décor Series Class A, Decor Series Street and Landmark and Décor Series Ultra products. CRI values are minimums for all other products. Minimum Rg value for 80 CRI products is 0, the minimum Rg values for 90 CRI products is 50, the minimum Rg values for 97 CRI products is 93. Bridgelux maintains a ± 3 tolerance on CRI and Rg values.
- Drive current is referred to as nominal drive current.
- Typical stabilized DC performance values are provided as reference only and are not a guarantee of performance.
- Typical performance is estimated based on operation under DC (direct current) with LED array mounted onto a heat sink with thermal interface material and the case temperature maintained at 85°C . Based on Bridgelux test setup, values may vary depending on the thermal design of the luminaire and/or the exposed environment to which the product is subjected.
- Minimum flux values at elevated temperatures are provided for reference only and are not guaranteed by 100% production testing. Based on Bridgelux test setup, values may vary depending on the thermal design of the luminaire and/or the exposed environment to which the product is subjected.
- Nominal CCT is defined by the Lighting Research Center's Class A definition. The center of the Class A color bin is on the corresponding isothermal line.
- GAI value is 80. To help ensure optimal fixture level performance, GAI is measured at the fixture level, on axis, at a case temperature of 70°C . GAI may vary depending on fixture design and performance.

European Product Registry for Energy Labeling

The European Product Registry for Energy Labeling (EPREL) is defined in the EU Regulation 2017/1369 to provide important energy efficiency information to consumers. Together with Energy Labeling Regulation ELR (EU) 2019/2015 which was amended by regulation (EU) 2021/340 for energy labelling of light sources, manufacturers are required to declare an energy class based on key technical specifications from each of their product and register it in an open data base managed by EPREL. It is now a legal requirement for a vendor of light sources to upload information about their products into the EPREL database before placing these products on the market in the EU.

Table 4 below provides a list of part numbers that are in compliance with ELR and are currently listed in the EPREL database.

At Bridgelux, we are fully committed to supplying products that are compliant with pertinent laws, rules, and obligation imposed by relevant government bodies including the European Energy Labeling regulation. Customers can use these products with full confidence for any projects that fall under the ELR.

Table 4: Part numbers registered in European Product Registry for Energy Labeling

PART NUMBER ¹	CCT (K)	CRI	Current ² (mA)	Vf (V)	Useful flux ³ (Φ_{use}) at 85C (lm)	Power (W)	Efficacy (lm/W)	Energy efficiency class ⁴	Registration No	URL to Product Information Sheet in EPREL Database
BXRC-20B10K1-C-7X	2000	65	2390	69.1	21628	165.2	131	E	870973	https://eprelec.europa.eu/qr/870973
BXRC-20B10K1-D-7X	2000	65	3200	38.7	16175	123.9	131	E	870975	https://eprelec.europa.eu/qr/870975
BXRC-25E10K0-B-7X	2500	80	3570	54.2	23086	193.6	119	E	870981	https://eprelec.europa.eu/qr/870981
BXRC-25E10K0-C-7X	2500	80	3080	71.3	26214	219.7	119	E	870983	https://eprelec.europa.eu/qr/870983
BXRC-25E10K0-D-7X	2500	80	4020	39.9	19095	160.4	119	E	870985	https://eprelec.europa.eu/qr/870985
BXRC-27E10K0-B-7X	2700	80	3600	54.3	24344	195.5	125	E	871015	https://eprelec.europa.eu/qr/871015
BXRC-27E10K0-C-7X	2700	80	3420	72.4	29881	247.6	121	E	871020	https://eprelec.europa.eu/qr/871020
BXRC-27E10K0-D-7X	2700	80	4200	40.2	20712	168.7	123	E	871025	https://eprelec.europa.eu/qr/871025
BXRC-27G1KH0-B-7X	2700	90	3060	53.1	18222	162.5	112	F	871112	https://eprelec.europa.eu/qr/871112
BXRC-27G1KH0-C-7X	2700	90	2570	69.7	20119	179.2	112	F	871116	https://eprelec.europa.eu/qr/871116
BXRC-27G1KH0-D-7X	2700	90	3420	39.0	14949	133.5	112	F	871120	https://eprelec.europa.eu/qr/871120
BXRC-27G10K0-B-7X	2700	90	2670	52.2	15613	139.4	112	F	871096	https://eprelec.europa.eu/qr/871096
BXRC-27G10K0-C-7X	2700	90	2190	68.5	16815	150.0	112	F	871101	https://eprelec.europa.eu/qr/871101
BXRC-27G10K0-D-7X	2700	90	2970	38.4	12737	114.0	112	F	871106	https://eprelec.europa.eu/qr/871106
BXRC-27H10K0-D-7X	2700	95	1860	36.7	7354	68.3	108	F	871201	https://eprelec.europa.eu/qr/871201
BXRC-30C10K1-B-7X	3000	70	3600	54.3	27083	195.5	139	E	871274	https://eprelec.europa.eu/qr/871274
BXRC-30C10K1-C-7X	3000	70	3420	72.4	33243	247.6	134	E	871280	https://eprelec.europa.eu/qr/871280
BXRC-30C10K1-D-7X	3000	70	4200	40.2	23042	168.7	137	E	871286	https://eprelec.europa.eu/qr/871286

Notes for Table 4:

- All device listed here must be disposed as e-waste upon its end of life according to local country guideline in each country.
- For information on performance values at alternative drive conditions, please refer to the Product Selection Guide, Absolute Maximum Rating Table and Performance Curves in this data sheet.
- For a definition of useful luminous flux (Φ_{use}), please see the ELR regulations at <https://tinyurl.com/4b6zvt4m>.
- EPREL requires an arrow symbol containing the letter of the energy efficiency class to be displayed, on technical promotional material. Refer to this energy efficiency class column for specific energy efficiency class on each part number.

European Product Registry for Energy Labeling

Table 4: Part numbers registered in European Product Registry for Energy Labeling (Continued)

PART NUMBER ¹	CCT (K)	CRI	Current ² (mA)	Vf (V)	Useful flux ³ (Φ_{use}) at 85C (lm)	Power (W)	Efficacy (lm/W)	Energy efficiency class ⁴	Registration No	URL to Product Information Sheet in EPREL Database
BXRC-30E10K0-B-7X	3000	80	3600	54.3	25865	195.5	132	E	871345	https://eprel.ec.europa.eu/qr/871345
BXRC-30E10K0-C-7X	3000	80	3420	72.4	31749	247.6	128	E	871350	https://eprel.ec.europa.eu/qr/871350
BXRC-30E10K0-D-7X	3000	80	4200	40.2	22007	168.7	130	E	871355	https://eprel.ec.europa.eu/qr/871355
BXRC-30G1KH0-B-7X	3000	90	3550	54.2	21632	192.4	112	F	871450	https://eprel.ec.europa.eu/qr/871450
BXRC-30G1KH0-C-7X	3000	90	3060	71.3	24539	218.1	113	F	871454	https://eprel.ec.europa.eu/qr/871454
BXRC-30G1KH0-D-7X	3000	90	4000	39.9	17900	159.5	112	F	871458	https://eprel.ec.europa.eu/qr/871458
BXRC-30G10K0-B-7X	3000	90	3130	53.2	18707	166.7	112	F	871434	https://eprel.ec.europa.eu/qr/871434
BXRC-30G10K0-C-7X	3000	90	2640	69.9	20746	184.6	112	F	871439	https://eprel.ec.europa.eu/qr/871439
BXRC-30G10K0-D-7X	3000	90	3510	39.2	15395	137.5	112	F	871444	https://eprel.ec.europa.eu/qr/871444
BXRC-30H10K0-D-7X	3000	95	2650	37.9	10891	100.5	108	F	871547	https://eprel.ec.europa.eu/qr/871547
BXRC-30A10K1-B-7X	3000	90	2010	50.7	11359	101.9	112	F	871242	https://eprel.ec.europa.eu/qr/871242
BXRC-30A10K1-C-7X	3000	90	1560	66.4	11559	103.6	112	F	871243	https://eprel.ec.europa.eu/qr/871243
BXRC-30A10K1-D-7X	3000	90	2210	37.3	9151	82.4	111	F	871244	https://eprel.ec.europa.eu/qr/871244
BXRC-35E10K0-B-7X	3500	80	3600	54.3	26474	195.5	135	E	871619	https://eprel.ec.europa.eu/qr/871619
BXRC-35E10K0-C-7X	3500	80	3420	72.4	32496	247.6	131	E	871624	https://eprel.ec.europa.eu/qr/871624
BXRC-35E10K0-D-7X	3500	80	4200	40.2	22525	168.7	134	E	871629	https://eprel.ec.europa.eu/qr/871629
BXRC-35G10K0-B-7X	3500	90	3480	54.0	21144	188.1	112	F	871687	https://eprel.ec.europa.eu/qr/871687
BXRC-35G10K0-C-7X	3500	90	2990	71.1	23905	212.4	113	F	871692	https://eprel.ec.europa.eu/qr/871692
BXRC-35G10K0-D-7X	3500	90	3920	39.8	17487	155.9	112	F	871697	https://eprel.ec.europa.eu/qr/871697
BXRC-35A10K1-B-7X	3500	90	2670	52.2	15613	139.4	112	F	871588	https://eprel.ec.europa.eu/qr/871588
BXRC-35A10K1-C-7X	3500	90	2190	68.5	16815	150.0	112	F	871589	https://eprel.ec.europa.eu/qr/871589
BXRC-35A10K1-D-7X	3500	90	2970	38.4	12737	114.0	112	F	871590	https://eprel.ec.europa.eu/qr/871590
BXRC-40C10K1-B-7X	4000	70	3600	54.3	27843	195.5	142	E	871777	https://eprel.ec.europa.eu/qr/871777
BXRC-40C10K1-C-7X	4000	70	3420	72.4	34176	247.6	138	E	871783	https://eprel.ec.europa.eu/qr/871783
BXRC-40C10K1-D-7X	4000	70	4200	40.2	23690	168.7	140	E	871789	https://eprel.ec.europa.eu/qr/871789
BXRC-40E10K0-B-7X	4000	80	3600	54.3	26626	195.5	136	E	871851	https://eprel.ec.europa.eu/qr/871851
BXRC-40E10K0-C-7X	4000	80	3420	72.4	32682	247.6	132	E	871856	https://eprel.ec.europa.eu/qr/871856
BXRC-40E10K0-D-7X	4000	80	4200	40.2	22654	168.7	134	E	871861	https://eprel.ec.europa.eu/qr/871861
BXRC-40G10K0-B-7X	4000	90	3600	54.3	22214	195.5	114	F	871920	https://eprel.ec.europa.eu/qr/871920
BXRC-40G10K0-C-7X	4000	90	3190	71.7	25745	228.7	113	F	871925	https://eprel.ec.europa.eu/qr/871925
BXRC-40G10K0-D-7X	4000	90	4160	40.1	18726	166.8	112	F	871930	https://eprel.ec.europa.eu/qr/871930
BXRC-40H10K0-D-7X	4000	95	3320	38.9	14041	129.1	109	F	871976	https://eprel.ec.europa.eu/qr/871976
BXRC-40A10K1-B-7X	4000	90	3480	54.0	21144	188.1	112	F	871743	https://eprel.ec.europa.eu/qr/871743
BXRC-40A10K1-C-7X	4000	90	2990	71.1	23905	212.4	113	F	871744	https://eprel.ec.europa.eu/qr/871744
BXRC-40A10K1-D-7X	4000	90	3920	39.8	17487	155.9	112	F	871745	https://eprel.ec.europa.eu/qr/871745

Notes for Table 4:

- All device listed here must be disposed as e-waste upon its end of life according to local country guideline in each country.
- For information on performance values at alternative drive conditions, please refer to the Product Selection Guide, Absolute Maximum Rating Table and Performance Curves in this data sheet.
- For a definition of useful luminous flux (Φ_{use}), please see the ELR regulations at <https://tinyurl.com/4b6zvt4m>.
- EPREL requires an arrow symbol containing the letter of the energy efficiency class to be displayed, on technical promotional material. Refer to this energy efficiency class column for specific energy efficiency class on each part number.

European Product Registry for Energy Labeling

Table 4: Part numbers registered in European Product Registry for Energy Labeling (Continued)

PART NUMBER ¹	CCT (K)	CRI	Current ² (mA)	Vf (V)	Useful flux ³ (Φ_{use}) at 85C (lm)	Power (W)	Efficacy (lm/W)	Energy efficiency class ⁴ 	Registration No	URL to Product Information Sheet in EPREL Database
BXRC-50C10K1-B-7X	5000	70	3600	54.3	27995	195.5	143	E	872007	https://eprelec.europa.eu/qr/872007
BXRC-50C10K1-C-7X	5000	70	3420	72.4	34363	247.6	139	E	872011	https://eprelec.europa.eu/qr/872011
BXRC-50C10K1-D-7X	5000	70	4200	40.2	23819	168.7	141	E	872015	https://eprelec.europa.eu/qr/872015
BXRC-50E10K1-B-7X	5000	80	3600	54.3	26930	195.5	138	E	872059	https://eprelec.europa.eu/qr/872059
BXRC-50E10K1-C-7X	5000	80	3420	72.4	33056	247.6	133	E	872063	https://eprelec.europa.eu/qr/872063
BXRC-50E10K1-D-7X	5000	80	4200	40.2	22913	168.7	136	E	872067	https://eprelec.europa.eu/qr/872067
BXRC-50G10K1-B-7X	5000	90	3600	54.3	23279	195.5	119	E	872111	https://eprelec.europa.eu/qr/872111
BXRC-50G10K1-C-7X	5000	90	3420	72.4	28574	247.6	115	F	872115	https://eprelec.europa.eu/qr/872115
BXRC-50G10K1-D-7X	5000	90	4200	40.2	19806	168.7	117	F	872119	https://eprelec.europa.eu/qr/872119
BXRC-56G10K0-B-7X	5600	90	3600	54.3	23431	195.5	120	E	872152	https://eprelec.europa.eu/qr/872152
BXRC-56G10K0-C-7X	5600	90	3420	72.4	28761	247.6	116	F	872153	https://eprelec.europa.eu/qr/872153
BXRC-56G10K0-D-7X	5600	90	4200	40.2	19936	168.7	118	F	872154	https://eprelec.europa.eu/qr/872154
BXRC-56H10K1-D-7X	5600	95	3920	39.8	16998	155.9	109	F	872189	https://eprelec.europa.eu/qr/872189
BXRC-57C10K1-B-7X	5700	70	3600	54.3	27235	195.5	139	E	872216	https://eprelec.europa.eu/qr/872216
BXRC-57C10K1-C-7X	5700	70	3420	72.4	33429	247.6	135	E	872220	https://eprelec.europa.eu/qr/872220
BXRC-57C10K1-D-7X	5700	70	4200	40.2	23172	168.7	137	E	872224	https://eprelec.europa.eu/qr/872224
BXRC-57E10K1-B-7X	5700	80	3600	54.3	25865	195.5	132	E	872265	https://eprelec.europa.eu/qr/872265
BXRC-57E10K1-C-7X	5700	80	3420	72.4	31749	247.6	128	E	872269	https://eprelec.europa.eu/qr/872269
BXRC-57E10K1-D-7X	5700	80	4200	40.2	22007	168.7	130	E	872273	https://eprelec.europa.eu/qr/872273
BXRC-65C10K1-B-7X	6500	70	3600	54.3	27235	195.5	139	E	872313	https://eprelec.europa.eu/qr/872313
BXRC-65C10K1-C-7X	6500	70	3420	72.4	33429	247.6	135	E	872317	https://eprelec.europa.eu/qr/872317
BXRC-65C10K1-D-7X	6500	70	4200	40.2	23172	168.7	137	E	872321	https://eprelec.europa.eu/qr/872321
BXRC-65E10K1-B-7X	6500	80	3600	54.3	26170	195.5	134	E	872363	https://eprelec.europa.eu/qr/872363
BXRC-65E10K1-C-7X	6500	80	3420	72.4	32122	247.6	130	E	872367	https://eprelec.europa.eu/qr/872367
BXRC-65E10K1-D-7X	6500	80	4200	40.2	22266	168.7	132	E	872371	https://eprelec.europa.eu/qr/872371

Notes for Table 4:

1. All device listed here must be disposed as e-waste upon its end of life according to local country guideline in each country.
2. For information on performance values at alternative drive conditions, please refer to the Product Selection Guide, Absolute Maximum Rating Table and Performance Curves in this data sheet.
3. For a definition of useful luminous flux (Φ_{use}), please see the ELR regulations at <https://tinyurl.com/4b6zvt4m>.
4. EPREL requires an arrow symbol containing the letter of the energy efficiency class to be displayed, on technical promotional material. Refer to this energy efficiency class column for specific energy efficiency class on each part number.

Performance at Commonly Used Drive Currents

Vero LED arrays are tested to the specifications shown using the nominal drive currents in Table 1. Vero may also be driven at other drive currents dependent on specific application design requirements. The performance at any drive current can be derived from the current vs. voltage characteristics shown in Figures 1, 2 & 3 and the flux vs. current characteristics shown in Figures 4, 5 & 6. The performance at commonly used drive currents is summarized in Table 5.

Table 5: Product Performance at Commonly Used Drive Currents

Part Number	CRI	Drive Current ¹ (mA)	Typical V _f T _c = 25°C (V)	Typical Power T _c = 25°C (W)	Typical Flux ² T _c = 25°C (lm)	Typical DC Flux ³ T _c = 85°C (lm)	Typical Efficacy T _c = 25°C (lm/W)
BXRC-17E10K0-B-7x	80	900	49.6	44.7	4470	4081	100
		1200	50.5	60.6	5886	5350	97
		1800	52.0	93.6	8611	7750	92
		2700	54.1	146.1	12413	11070	85
		3600	55.8	201.0	15887	13998	79
BXRC-17E10K0-C-7x	80	855	66.2	56.6	6202	5902	110
		1140	67.3	76.7	7883	7272	103
		1710	69.4	118.7	10918	9826	92
		2565	72.1	185.0	15489	13321	84
		3420	74.4	254.6	19413	16313	76
BXRC-17E10K0-D-7x	80	1050	35.4	37.2	3996	3893	107
		1400	36.2	50.7	5142	4786	101
		2100	37.6	78.9	7264	6538	92
		3150	39.5	124.4	10342	8714	83
		4200	41.2	173.0	13034	10644	75
BXRC-20B10K0-C-7x	65	855	66.2	56.6	10584	10072	187
		1140	67.3	76.7	13452	12409	175
		1710	69.4	118.7	18632	16769	157
		2565	72.1	185.0	26432	22733	143
		3420	74.4	254.6	33129	27838	130
BXRC-20B10K0-D-7x	65	1050	35.4	37.2	6819	6644	183
		1400	36.2	50.7	8776	8167	173
		2100	37.6	78.9	12397	11157	157
		3150	39.5	124.4	17649	14870	142
		4200	41.2	173.0	22243	18164	129
BXRC-25E10K0-B-7x	80	900	49.6	44.7	7434	6786	166
		1200	50.5	60.6	9789	8898	162
		1800	52.0	93.6	14321	12889	153
		2700	54.1	146.1	20643	18410	141
		3600	55.8	201.0	26421	23279	131
BXRC-25E10K0-C-7x	80	855	66.2	56.6	10315	9815	182
		1140	67.3	76.7	13110	12093	171
		1710	69.4	118.7	18157	16341	153
		2565	72.1	185.0	25758	22154	139
		3420	74.4	254.6	32285	27129	127
BXRC-25E10K0-D-7x	80	1050	35.4	37.2	6645	6475	179
		1400	36.2	50.7	8552	7959	169
		2100	37.6	78.9	12081	10873	153
		3150	39.5	124.4	17199	14492	138
		4200	41.2	173.0	21677	17701	125

Notes for Table 5:

1. Alternate drive currents are provided for reference only and are not a guarantee of performance.
2. Bridgelux maintains a ± 7% tolerance on flux measurements.
3. Typical stabilized DC performance values are provided as reference only and are not a guarantee of performance.

Performance at Commonly Used Drive Currents

Table 5: Product Performance at Commonly Used Drive Currents (Continued)

Part Number	CRI	Drive Current ¹ (mA)	Typical V _f T _c = 25°C (V)	Typical Power T _c = 25°C (W)	Typical Flux ² T _c = 25°C (lm)	Typical DC Flux ³ T _c = 85°C (lm)	Typical Efficacy T _c = 25°C (lm/W)
BXRC-27E10Ko-B-7x	80	900	49.6	44.7	7774	7097	174
		1200	50.5	60.6	10237	9305	169
		1800	52.0	93.6	14976	13478	160
		2700	54.1	146.1	21588	19252	148
		3600	55.8	201.0	27630	24344	137
BXRC-27E10Ko-C-7x	80	855	66.2	56.6	10786	10264	191
		1140	67.3	76.7	13709	12646	179
		1710	69.4	118.7	18988	17089	160
		2565	72.1	185.0	26937	23168	146
		3420	74.4	254.6	33762	28370	133
BXRC-27E10Ko-D-7x	80	1050	35.4	37.2	6949	6771	187
		1400	36.2	50.6	8943	8323	177
		2100	37.6	79.0	12634	11370	160
		3150	39.5	124.4	17986	15155	145
		4200	41.2	172.9	22668	18511	131
BXRC-27G1KH0-B-7x	90	900	49.6	44.7	6657	6076	149
		1200	50.5	60.6	8765	7968	145
		1800	52.0	93.6	12823	11541	137
		2700	54.1	146.1	18484	16485	127
		3600	55.8	201.0	23658	20844	118
BXRC-27G1KH0-C-7x	90	855	66.2	56.6	9236	8789	163
		1140	67.3	76.7	11739	10828	153
		1710	69.4	118.7	16258	14633	137
		2565	72.1	185.0	23064	19837	125
		3420	74.4	254.6	28909	24292	114
BXRC-27G1KH0-D-7x	90	1050	35.4	37.2	5950	5798	160
		1400	36.2	50.6	7658	7127	151
		2100	37.6	79.0	10818	9736	137
		3150	39.5	124.4	15400	12976	124
		4200	41.2	172.9	19410	15850	112
BXRC-27G10Ko-B-7x	90	900	49.6	44.7	6414	5855	144
		1200	50.5	60.6	8445	7677	139
		1800	52.0	93.6	12355	11120	132
		2700	54.1	146.1	17810	15883	122
		3600	55.8	201.0	22795	20084	113
BXRC-27G10Ko-C-7x	90	855	66.2	56.6	8899	8468	157
		1140	67.3	76.7	11310	10433	147
		1710	69.4	118.7	15665	14098	132
		2565	72.1	185.0	22223	19113	120
		3420	74.4	254.6	27854	23405	109
BXRC-27G10Ko-D-7x	90	1050	35.4	37.2	5733	5586	154
		1400	36.2	50.6	7378	6866	146
		2100	37.6	79.0	10423	9380	132
		3150	39.5	124.4	14838	12503	119
		4200	41.2	172.9	18701	15271	108

Notes for Table 5:

1. Alternate drive currents are provided for reference only and are not a guarantee of performance.
2. Bridgelux maintains a ± 7% tolerance on flux measurements.
3. Typical stabilized DC performance values are provided as reference only and are not a guarantee of performance.

Performance at Commonly Used Drive Currents

Table 5: Product Performance at Commonly Used Drive Currents (Continued)

Part Number	CRI	Drive Current ¹ (mA)	Typical V _f T _c = 25°C (V)	Typical Power T _c = 25°C (W)	Typical Flux ² T _c = 25°C (lm)	Typical DC Flux ³ T _c = 85°C (lm)	Typical Efficacy T _c = 25°C (lm/W)
BXRC-27H10K0-D-7x	97	1050	35.4	37.2	5084	4954	137
		1400	36.2	50.6	6543	6089	129
		2100	37.6	79.0	9243	8319	117
		3150	39.5	124.4	13159	11087	106
		4200	41.2	172.9	16585	13543	96
BXRC-30C10K1-B-7x	70	900	49.6	44.7	9464	9006	212
		1200	50.5	60.6	12029	11096	199
		1800	52.0	93.6	16661	14995	178
		2700	54.1	146.1	23635	20328	162
		3600	55.8	201.0	29625	24893	147
BXRC-30C10K1-C-7x	70	855	66.2	56.6	11619	11321	205
		1140	67.3	76.7	14954	13916	195
		1710	69.4	118.7	21124	19012	178
		2565	72.1	185.0	30073	25339	163
		3420	74.4	254.6	37903	30951	149
BXRC-30C10K1-D-7x	70	1050	35.4	37.2	7731	7533	208
		1400	36.2	50.6	9949	9259	196
		2100	37.6	79.0	14055	12649	178
		3150	39.5	124.4	20009	16860	161
		4200	41.2	172.9	25219	20593	146
BXRC-30E10K0-B-7x	80	900	49.6	44.7	8260	7540	185
		1200	50.5	60.6	10876	9887	180
		1800	52.0	93.6	15912	14321	170
		2700	54.1	146.1	22937	20455	157
		3600	55.8	201.0	29357	25865	146
BXRC-30E10K0-C-7x	80	855	66.2	56.6	11461	10906	203
		1140	67.3	76.7	14566	13437	190
		1710	69.4	118.7	20175	18157	170
		2565	72.1	185.0	28620	24615	155
		3420	74.4	254.6	35873	30143	141
BXRC-30E10K0-D-7x	80	1050	35.4	37.2	7383	7194	198
		1400	36.2	50.6	9502	8843	188
		2100	37.6	79.0	13423	12081	170
		3150	39.5	124.4	19110	16102	154
		4200	41.2	172.9	24085	19668	139
BXRC-30G1KH0-B-7X	90	900	49.6	44.7	6997	6387	157
		1200	50.5	60.6	9213	8375	152
		1800	52.0	93.6	13478	12131	144
		2700	54.1	146.1	19429	17327	133
		3600	55.8	201.0	24867	21909	124
BXRC-30G1KH0-C-7x	90	855	66.2	56.6	9708	9238	172
		1140	67.3	76.7	12339	11382	161
		1710	69.4	118.7	17089	15380	144
		2565	72.1	185.0	24243	20851	131
		3420	74.4	254.6	30386	25533	119

Notes for Table 5:

1. Alternate drive currents are provided for reference only and are not a guarantee of performance.
2. Bridgelux maintains a ± 7% tolerance on flux measurements.
3. Typical stabilized DC performance values are provided as reference only and are not a guarantee of performance.

Performance at Commonly Used Drive Currents

Table 5: Product Performance at Commonly Used Drive Currents (Continued)

Part Number	CRI	Drive Current ¹ (mA)	Typical V _f T _c = 25°C (V)	Typical Power T _c = 25°C (W)	Typical Flux ² T _c = 25°C (lm)	Typical DC Flux ³ T _c = 85°C (lm)	Typical Efficacy T _c = 25°C (lm/W)
BXRC-30G1KH0-D-7x	90	1050	35.4	37.2	6254	6094	168
		1400	36.2	50.6	8049	7491	159
		2100	37.6	79.0	11370	10233	144
		3150	39.5	124.4	16187	13639	130
		4200	41.2	172.9	20402	16660	118
BXRC-30G10K0-B-7x	90	900	49.6	44.7	6705	6121	150
		1200	50.5	60.6	8829	8026	146
		1800	52.0	93.6	12917	11625	138
		2700	54.1	146.1	18619	16605	127
		3600	55.8	201.0	23831	20997	119
BXRC-30G10K0-C-7x	90	855	66.2	56.6	9303	8853	164
		1140	67.3	76.7	11824	10907	154
		1710	69.4	118.7	16377	14739	138
		2565	72.1	185.0	23233	19982	126
		3420	74.4	254.6	29120	24469	114
BXRC-30G10K0-D-7x	90	1050	35.4	37.2	5994	5840	161
		1400	36.2	50.6	7714	7179	152
		2100	37.6	79.0	10896	9807	138
		3150	39.5	124.4	15513	13071	125
		4200	41.2	172.9	19552	15966	113
BXRC-30H10K0-D-7x	97	1050	35.4	37.2	5429	5290	146
		1400	36.2	50.6	6987	6502	138
		2100	37.6	79.0	9870	8883	125
		3150	39.5	124.4	14051	11840	113
		4200	41.2	172.9	17710	14462	102
BXRC-30A10K1-B-7x	93	900	49.6	44.7	6025	5500	135
		1200	50.5	60.6	7933	7212	131
		1800	52.0	93.6	11606	10446	124
		2700	54.1	146.1	16730	14920	115
		3600	55.8	201.0	21413	18867	107
BXRC-30A10K1-C-7x	93	855	66.2	56.6	8359	7955	148
		1140	67.3	76.7	10625	9801	139
		1710	69.4	118.7	14716	13244	124
		2565	72.1	185.0	20876	17955	113
		3420	74.4	254.6	26166	21987	103
BXRC-30A10K1-D-7x	93	1050	35.4	37.2	5386	5248	145
		1400	36.2	50.6	6931	6450	137
		2100	37.6	79.0	9791	8812	124
		3150	39.5	124.4	13939	11745	112
		4200	41.2	172.9	17568	14346	102
BXRC-35E10K0-B-7x	80	900	49.6	44.7	8455	7718	189
		1200	50.5	60.6	11132	10119	184
		1800	52.0	93.6	16286	14658	174
		2700	54.1	146.1	23477	20937	161
		3600	55.8	201.0	30047	26474	149

Notes for Table 5:

1. Alternate drive currents are provided for reference only and are not a guarantee of performance.
2. Bridgelux maintains a ± 7% tolerance on flux measurements.
3. Typical stabilized DC performance values are provided as reference only and are not a guarantee of performance.

Performance at Commonly Used Drive Currents

Table 5: Product Performance at Commonly Used Drive Currents (Continued)

Part Number	CRI	Drive Current ¹ (mA)	Typical V _f T _c = 25°C (V)	Typical Power T _c = 25°C (W)	Typical Flux ² T _c = 25°C (lm)	Typical DC Flux ³ T _c = 85°C (lm)	Typical Efficacy T _c = 25°C (lm/W)
BXRC-35E10Ko-C-7x	80	855	66.2	56.6	11730	11162	207
		1140	67.3	76.7	14909	13753	194
		1710	69.4	118.7	20649	18584	174
		2565	72.1	185.0	29294	25195	158
		3420	74.4	254.6	36717	30852	144
BXRC-35E10Ko-D-7x	80	1050	35.4	37.2	7557	7363	203
		1400	36.2	50.6	9726	9051	192
		2100	37.6	79.0	13739	12365	174
		3150	39.5	124.4	19560	16481	157
		4200	41.2	172.9	24652	20130	143
BXRC-35G10Ko-B-7x	90	900	49.6	44.7	6948	6343	156
		1200	50.5	60.6	9149	8317	151
		1800	52.0	93.6	13385	12046	143
		2700	54.1	146.1	19294	17207	132
		3600	55.8	201.0	24694	21757	123
BXRC-35G10Ko-C-7x	90	855	66.2	56.6	9640	9174	170
		1140	67.3	76.7	12253	11302	160
		1710	69.4	118.7	16970	15273	143
		2565	72.1	185.0	24075	20706	130
		3420	74.4	254.6	30175	25356	119
BXRC-35G10Ko-D-7x	90	1050	35.4	37.2	6211	6052	167
		1400	36.2	50.6	7993	7439	158
		2100	37.6	79.0	11291	10162	143
		3150	39.5	124.4	16075	13544	129
		4200	41.2	172.9	20260	16544	117
BXRC-35A10K1-B-7x	93	900	49.6	44.7	6414	5855	144
		1200	50.5	60.6	8445	7677	139
		1800	52.0	93.6	12355	11120	132
		2700	54.1	146.1	17810	15883	122
		3600	55.8	201.0	22795	20084	113
BXRC-35A10K1-C-7x	93	855	66.2	56.6	8899	8468	157
		1140	67.3	76.7	11310	10433	147
		1710	69.4	118.7	15665	14098	132
		2565	72.1	185.0	22223	19113	120
		3420	74.4	254.6	27854	23405	109
BXRC-35A10K1-D-7x	93	1050	35.4	37.2	5733	5586	154
		1400	36.2	50.6	7378	6866	146
		2100	37.6	79.0	10423	9380	132
		3150	39.5	124.4	14838	12503	119
		4200	41.2	172.9	18701	15271	108
BXRC-40C10K1-B-7x	70	900	49.6	44.7	8892	8117	199
		1200	50.5	60.6	11708	10643	193
		1800	52.0	93.6	17129	15416	183
		2700	54.1	146.1	24691	22020	169
		3600	55.8	201.0	31602	27843	157

Notes for Table 5:

1. Alternate drive currents are provided for reference only and are not a guarantee of performance.
2. Bridgelux maintains a ± 7% tolerance on flux measurements.
3. Typical stabilized DC performance values are provided as reference only and are not a guarantee of performance.

Performance at Commonly Used Drive Currents

Table 5: Product Performance at Commonly Used Drive Currents (Continued)

Part Number	CRI	Drive Current ¹ (mA)	Typical V _f T _c = 25°C (V)	Typical Power T _c = 25°C (W)	Typical Flux ² T _c = 25°C (lm)	Typical DC Flux ³ T _c = 85°C (lm)	Typical Efficacy T _c = 25°C (lm/W)
BXRC-40C10K1-C-7x	70	855	66.2	56.6	12337	11740	218
		1140	67.3	76.7	15680	14464	204
		1710	69.4	118.7	21717	19546	183
		2565	72.1	185.0	30809	26498	167
		3420	74.4	254.6	38616	32448	152
BXRC-40C10K1-D-7x	70	1050	35.4	37.2	7948	7744	214
		1400	36.2	50.6	10229	9519	202
		2100	37.6	79.0	14450	13005	183
		3150	39.5	124.4	20571	17333	165
		4200	41.2	172.9	25927	21172	150
BXRC-40E10K0-B-7x	80	900	49.6	44.7	8503	7762	190
		1200	50.5	60.6	11196	10178	185
		1800	52.0	93.6	16380	14742	175
		2700	54.1	146.1	23611	21057	162
		3600	55.8	201.0	30220	26626	150
BXRC-40E10K0-C-7x	80	855	66.2	56.6	11798	11227	209
		1140	67.3	76.7	14995	13832	195
		1710	69.4	118.7	20768	18691	175
		2565	72.1	185.0	29462	25339	159
		3420	74.4	254.6	36928	31030	145
BXRC-40E10K0-D-7x	80	1050	35.4	37.2	7601	7406	204
		1400	36.2	50.6	9782	9103	193
		2100	37.6	79.0	13818	12436	175
		3150	39.5	124.4	19672	16575	158
		4200	41.2	172.9	24794	20246	143
BXRC-40G10K0-B-7x	90	900	49.6	44.7	7094	6476	159
		1200	50.5	60.6	9341	8491	154
		1800	52.0	93.6	13666	12299	146
		2700	54.1	146.1	19699	17568	135
		3600	55.8	201.0	25212	22214	125
BXRC-40G10K0-C-7x	90	855	66.2	56.6	9843	9366	174
		1140	67.3	76.7	12510	11540	163
		1710	69.4	118.7	17326	15594	146
		2565	72.1	185.0	24580	21140	133
		3420	74.4	254.6	30808	25888	121
BXRC-40G10K0-D-7x	90	1050	35.4	37.2	6341	6179	170
		1400	36.2	50.6	8161	7595	161
		2100	37.6	79.0	11528	10375	146
		3150	39.5	124.4	16412	13829	132
		4200	41.2	172.9	20685	16891	120
BXRC-40H10K0-D-7x	97	1050	35.4	37.2	5733	5586	154
		1400	36.2	50.6	7378	6866	146
		2100	37.6	79.0	10423	9380	132
		3150	39.5	124.4	14838	12503	119
		4200	41.2	172.9	18701	15271	108

Notes for Table 5:

1. Alternate drive currents are provided for reference only and are not a guarantee of performance.
2. Bridgelux maintains a ± 7% tolerance on flux measurements.
3. Typical stabilized DC performance values are provided as reference only and are not a guarantee of performance.

Performance at Commonly Used Drive Currents

Table 5: Product Performance at Commonly Used Drive Currents (Continued)

Part Number	CRI	Drive Current ¹ (mA)	Typical V _f T _c = 25°C (V)	Typical Power T _c = 25°C (W)	Typical Flux ² T _c = 25°C (lm)	Typical DC Flux ³ T _c = 85°C (lm)	Typical Efficacy T _c = 25°C (lm/W)
BXRC-40A10K1-B-7x	93	900	49.6	44.7	6948	6343	156
		1200	50.5	60.6	9149	8317	151
		1800	52.0	93.6	13385	12046	143
		2700	54.1	146.1	19294	17207	132
		3600	55.8	201.0	24694	21757	123
BXRC-40A10K1-C-7x	93	855	66.2	56.6	9640	9174	170
		1140	67.3	76.7	12253	11302	160
		1710	69.4	118.7	16970	15273	143
		2565	72.1	185.0	24075	20706	130
		3420	74.4	254.6	30175	25356	119
BXRC-40A10K1-D-7x	93	1050	35.4	37.2	6211	6052	167
		1400	36.2	50.6	7993	7439	158
		2100	37.6	79.0	11291	10162	143
		3150	39.5	124.4	16075	13544	129
		4200	41.2	172.9	20260	16544	117
BXRC-50C10K1-B-7x	70	900	49.6	44.7	8941	8161	200
		1200	50.5	60.6	11772	10701	194
		1800	52.0	93.6	17222	15500	184
		2700	54.1	146.1	24826	22140	170
		3600	55.8	201.0	31774	27995	158
BXRC-50C10K1-C-7x	70	855	66.2	56.6	12404	11804	219
		1140	67.3	76.7	15766	14543	206
		1710	69.4	118.7	21836	19652	184
		2565	72.1	185.0	30977	26643	167
		3420	74.4	254.6	38827	32625	153
BXRC-50C10K1-D-7x	70	1050	35.4	37.2	7991	7787	215
		1400	36.2	50.6	10285	9571	203
		2100	37.6	79.0	14529	13076	184
		3150	39.5	124.4	20684	17428	166
		4200	41.2	172.9	26069	21287	151
BXRC-50E10K1-B-7x	80	900	49.6	44.7	8600	7851	193
		1200	50.5	60.6	11324	10294	187
		1800	52.0	93.6	16567	14910	177
		2700	54.1	146.1	23881	21298	164
		3600	55.8	201.0	30565	26930	152
BXRC-50E10K1-C-7x	80	855	66.2	56.6	11932	11355	211
		1140	67.3	76.7	15166	13990	198
		1710	69.4	118.7	21005	18905	177
		2565	72.1	185.0	29799	25629	161
		3420	74.4	254.6	37350	31384	147
BXRC-50E10K1-D-7x	80	1050	35.4	37.2	7687	7490	207
		1400	36.2	50.6	9894	9207	195
		2100	37.6	79.0	13976	12578	177
		3150	39.5	124.4	19897	16765	160
		4200	41.2	172.9	25077	20478	145

Notes for Table 5:

1. Alternate drive currents are provided for reference only and are not a guarantee of performance.
2. Bridgelux maintains a ± 7% tolerance on flux measurements.
3. Typical stabilized DC performance values are provided as reference only and are not a guarantee of performance.

Performance at Commonly Used Drive Currents

Table 5: Product Performance at Commonly Used Drive Currents (Continued)

Part Number	CRI	Drive Current ¹ (mA)	Typical V _f T _c = 25°C (V)	Typical Power T _c = 25°C (W)	Typical Flux ² T _c = 25°C (lm)	Typical DC Flux ³ T _c = 85°C (lm)	Typical Efficacy T _c = 25°C (lm/W)
BXRC-50G10K1-B-7x	90	900	49.6	44.7	7434	6786	166
		1200	50.5	60.6	9789	8898	162
		1800	52.0	93.6	14321	12889	153
		2700	54.1	146.1	20643	18410	141
		3600	55.8	201.0	26421	23279	131
BXRC-50G10K1-C-7x	90	855	66.2	56.6	10315	9815	182
		1140	67.3	76.7	13110	12093	171
		1710	69.4	118.7	18157	16341	153
		2565	72.1	185.0	25758	22154	139
		3420	74.4	254.6	32285	27129	127
BXRC-50G10K1-D-7x	90	1050	35.4	37.2	6645	6475	179
		1400	36.2	50.6	8552	7959	169
		2100	37.6	79.0	12081	10873	153
		3150	39.5	124.4	17199	14492	138
		4200	41.2	172.9	21677	17701	125
BXRC-56G10K0-B-7x	80	900	49.6	44.7	7483	6831	168
		1200	50.5	60.6	9853	8956	163
		1800	52.0	93.6	14414	12973	154
		2700	54.1	146.1	20778	18530	142
		3600	55.8	201.0	26594	23431	132
BXRC-56G10K0-C-7x	80	855	66.2	56.6	10382	9879	183
		1140	67.3	76.7	13195	12172	172
		1710	69.4	118.7	18276	16448	154
		2565	72.1	185.0	25926	22299	140
		3420	74.4	254.6	32496	27306	128
BXRC-56G10K0-D-7x	80	1050	35.4	37.2	6689	6517	180
		1400	36.2	50.6	8608	8011	170
		2100	37.6	79.0	12160	10944	154
		3150	39.5	124.4	17311	14586	139
		4200	41.2	172.9	21818	17817	126
BXRC-56H10K1-D-7x	97	1050	35.4	37.2	6037	5882	162
		1400	36.2	50.6	7770	7231	153
		2100	37.6	79.0	10975	9878	139
		3150	39.5	124.4	15625	13166	126
		4200	41.2	172.9	19693	16081	114
BXRC-57C10K1-B-7x	70	900	49.6	44.7	8698	7939	195
		1200	50.5	60.6	11452	10410	189
		1800	52.0	93.6	16754	15079	179
		2700	54.1	146.1	24151	21538	165
		3600	55.8	201.0	30911	27235	154
BXRC-57C10K1-C-7x	70	855	66.2	56.6	12067	11483	213
		1140	67.3	76.7	15337	14148	200
		1710	69.4	118.7	21243	19118	179
		2565	72.1	185.0	30135	25919	163
		3420	74.4	254.6	37772	31739	148

Notes for Table 5:

1. Alternate drive currents are provided for reference only and are not a guarantee of performance.
2. Bridgelux maintains a ± 7% tolerance on flux measurements.
3. Typical stabilized DC performance values are provided as reference only and are not a guarantee of performance.

Performance at Commonly Used Drive Currents

Table 5: Product Performance at Commonly Used Drive Currents (Continued)

Part Number	CRI	Drive Current ¹ (mA)	Typical V _f T _c = 25°C (V)	Typical Power T _c = 25°C (W)	Typical Flux ² T _c = 25°C (lm)	Typical DC Flux ³ T _c = 85°C (lm)	Typical Efficacy T _c = 25°C (lm/W)
BXRC-57C10K1-D-7x	70	1050	35.4	37.2	7774	7575	209
		1400	36.2	50.6	10005	9311	198
		2100	37.6	79.0	14134	12720	179
		3150	39.5	124.4	20122	16954	162
		4200	41.2	172.9	25360	20709	147
BXRC-57E10K1-B-7x	80	900	49.6	44.7	8260	7540	185
		1200	50.5	60.6	10876	9887	180
		1800	52.0	93.6	15912	14321	170
		2700	54.1	146.1	22937	20455	157
		3600	55.8	201.0	29357	25865	146
BXRC-57E10K1-C-7x	80	855	66.2	56.6	11461	10906	203
		1140	67.3	76.7	14566	13437	190
		1710	69.4	118.7	20175	18157	170
		2565	72.1	185.0	28620	24615	155
		3420	74.4	254.6	35873	30143	141
BXRC-57E10K1-D-7x	80	1050	35.4	37.2	7383	7194	198
		1400	36.2	50.6	9502	8843	188
		2100	37.6	79.0	13423	12081	170
		3150	39.5	124.4	19110	16102	154
		4200	41.2	172.9	24085	19668	139
BXRC-65C10K1-B-7x	70	900	49.6	44.7	8698	7939	195
		1200	50.5	60.6	11452	10410	189
		1800	52.0	93.6	16754	15079	179
		2700	54.1	146.1	24151	21538	165
		3600	55.8	201.0	30911	27235	154
BXRC-65C10K1-C-7x	70	855	66.2	56.6	12067	11483	213
		1140	67.3	76.7	15337	14148	200
		1710	69.4	118.7	21243	19118	179
		2565	72.1	185.0	30135	25919	163
		3420	74.4	254.6	37772	31739	148
BXRC-65C10K1-D-7x	70	1050	35.4	37.2	7774	7575	209
		1400	36.2	50.6	10005	9311	198
		2100	37.6	79.0	14134	12720	179
		3150	39.5	124.4	20122	16954	162
		4200	41.2	172.9	25360	20709	147
BXRC-65E10K1-B-7x	80	900	49.6	44.7	8357	7629	187
		1200	50.5	60.6	11004	10003	182
		1800	52.0	93.6	16099	14489	172
		2700	54.1	146.1	23207	20696	159
		3600	55.8	201.0	29702	26170	148
BXRC-65E10K1-C-7x	80	855	66.2	56.6	11595	11034	205
		1140	67.3	76.7	14738	13595	192
		1710	69.4	118.7	20412	18371	172
		2565	72.1	185.0	28957	24905	157
		3420	74.4	254.6	36295	30498	143

Notes for Table 5:

1. Alternate drive currents are provided for reference only and are not a guarantee of performance.
2. Bridgelux maintains a ± 7% tolerance on flux measurements.
3. Typical stabilized DC performance values are provided as reference only and are not a guarantee of performance.

Performance at Commonly Used Drive Currents

Table 5: Product Performance at Commonly Used Drive Currents (Continued)

Part Number	CRI	Drive Current ¹ (mA)	Typical V_f $T_c = 25^\circ\text{C}$ (V)	Typical Power $T_c = 25^\circ\text{C}$ (W)	Typical Flux ² $T_c = 25^\circ\text{C}$ (lm)	Typical DC Flux ³ $T_c = 85^\circ\text{C}$ (lm)	Typical Efficacy $T_c = 25^\circ\text{C}$ (lm/W)
BXRC-65E10K1-D-7x	80	1050	35.4	37.2	7470	7279	201
		1400	36.2	50.6	9614	8947	190
		2100	37.6	79.0	13581	12223	172
		3150	39.5	124.4	19335	16291	155
		4200	41.2	172.9	24369	19899	141

Notes for Table 5:

1. Alternate drive currents are provided for reference only and are not a guarantee of performance.
2. Bridgelux maintains a $\pm 7\%$ tolerance on flux measurements.
3. Typical stabilized DC performance values are provided as reference only and are not a guarantee of performance.

Electrical Characteristics

Table 6: Electrical Characteristics

Part Number	Drive Current (mA)	Forward Voltage Pulsed, $T_c = 25^\circ\text{C}$ (V) ^{1, 2, 3, 8}			Typical Coefficient of Forward Voltage ⁴ $\Delta V_f / \Delta T_c$ (mV/ $^\circ\text{C}$)	Typical Thermal Resistance Junction to Case ^{5,6} R_{j-c} ($^\circ\text{C}/\text{W}$)	Driver Selection Voltages ⁷ (V)	
		Minimum	Typical	Maximum			V_f Min. Hot $T_c = 105^\circ\text{C}$ (V)	V_f Max. Cold $T_c = -40^\circ\text{C}$ (V)
BXRC-xxx10Kx-B-7x	1800	48.1	52.0	55.9	-24.9	0.06	46.1	57.5
	3600	51.7	55.8	60.0	-24.9	0.07	49.7	61.6
BXRC-xxx10Kx-C-7x	1710	64.2	69.4	74.6	-33.2	0.04	61.5	76.8
	3420	68.8	74.4	80.0	-33.2	0.05	66.2	82.2
BXRC-xxx10Kx-D-7x	2100	34.8	37.6	40.4	-17.4	0.06	33.4	41.6
	4200	38.1	41.2	44.3	-17.4	0.07	36.7	45.4

Notes for Table 6:

- Parts are tested in pulsed conditions. $T_c = 25^\circ\text{C}$. Pulse width is 10ms.
- Voltage minimum and maximum are provided for reference only and are not a guarantee of performance.
- Bridgelux maintains a tester tolerance of $\pm 0.10\text{V}$ on forward voltage measurements.
- Typical coefficient of forward voltage tolerance is $\pm 0.1\text{mV}$ for nominal current.
- Thermal resistance values are based from test data of a 3000K 80 CRI product.
- Thermal resistance value was calculated using total electrical input power; optical power was not subtracted from input power. The thermal interface material used during testing is not included in the thermal resistance value.
- V_f min hot and max cold values are provided as reference only and are not guaranteed by test. These values are provided to aid in driver design and selection over the operating range of the product.
- This product has been designed and manufactured per IEC 62031:2018. This product has passed dielectric withstand voltage testing at 1160 V. The working voltage designated for the insulation is 80V d.c. The maximum allowable voltage across the array must be determined in the end product application.

Eye Safety

Table 7: Eye Safety Risk Group (RG) Classifications

Part Number	Drive Current ⁵ (mA)	CCT ¹⁻⁵			
		2700K/3000K	4000K ²	5000K ³	6500K ⁴
BXRC-xxx10Kx-B-7x	1800	RG1	RG1	RG1	RG1
	2700	RG1	RG1	RG2	RG2
	3600	RG1	RG1	RG2	RG2
BXRC-xxx10Kx-C-7x	1710	RG1	RG1	RG1	RG2
	2565	RG1	RG1	RG2	RG2
	3420	RG1	RG2	RG2	RG2
BXRC-xxx10Kx-D-7x	2100	RG1	RG1	RG1	RG1
	3150	RG1	RG1	RG1	RG2
	4200	RG1	RG1	RG2	RG2

Notes for Table 7:

1. Eye safety classification for the use of Bridgelux Vero Series LED arrays is in accordance with specification IEC/TR 62778: Application of IEC 62471 for the assessment of blue light hazard to light sources and luminaires.
2. For products classified as RG2 at 4000K, $E_{thr} = 1847.5$ lx.
3. For products classified as RG2 at 5000K $E_{thr} = 1315.8$ lx.
4. For products classified as RG2 at 6500K, $E_{thr} = 1124.5$ lx.
5. Please contact your Bridgelux sales representative for E_{thr} values at specific drive currents and CCTs not listed

Absolute Maximum Ratings

Table 8: Maximum Ratings

Parameter	Maximum Rating		
LED Junction Temperature (T_j)	150°C		
Storage Temperature	-40°C to +105°C		
Operating Case Temperature ¹ (T_c)	105°C		
Soldering Temperature ²	300°C or lower for a maximum of 6 seconds		
	BXRC-xxx10Kx-B-7x	BXRC-xxx10Kx-C-7x	BXRC-xxx10Kx-D-7x
Maximum Drive Current ³	3600mA	3420mA	4200mA
Maximum Peak Pulsed Drive Current ^{4,5}	5140mA	4890mA	6000mA
Maximum Reverse Voltage ⁶	-90V	-120V	-65V

Notes for Table 8:

1. For IEC 62717 requirement, please consult your Bridgelux sales representative.
2. Refer to Bridgelux Application Note AN31: Assembly Considerations for Bridgelux Vero LED Arrays.
3. Arrays may be driven at higher currents however lumen maintenance may be reduced.
4. Per IEC 62031, LED Modules for General Lighting - Safety Specifications, the maximum allowable current when using the Molex Pico Connector is 3150mA.
5. Bridgelux recommends a maximum duty cycle of 10% and pulse width of 20 ms when operating LED Arrays at maximum peak pulsed current specified. Maximum peak pulsed currents indicate values where LED Arrays can be driven without catastrophic failures.
6. Light emitting diodes are not designed to be driven in reverse voltage and will not produce light under this condition. Maximum rating provided for reference only.

Performance Curves

Figure 1: Vero 29B Drive Current vs. Voltage

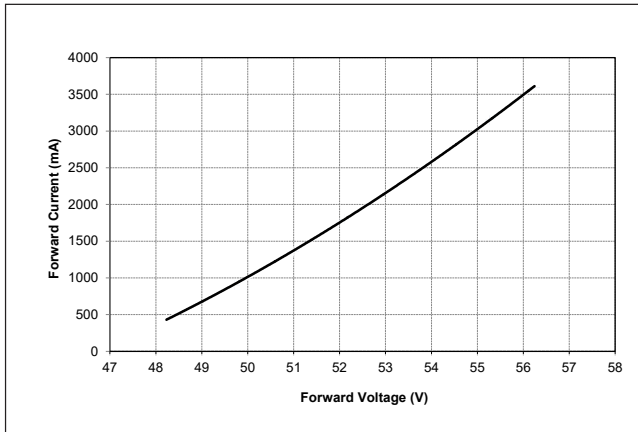

Figure 2: Vero 29C Drive Current vs. Voltage

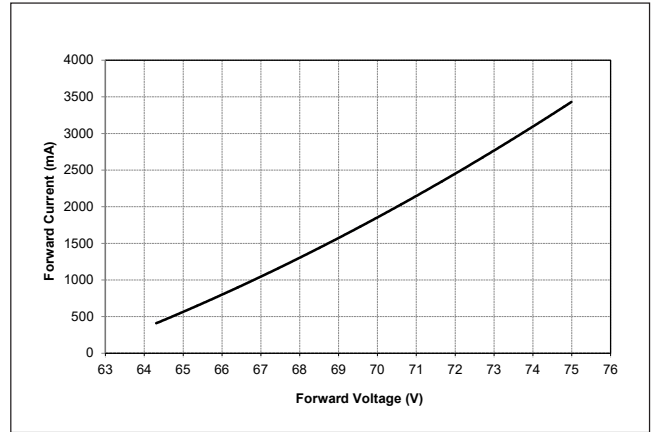

Figure 3: Vero 29D Drive Current vs. Voltage

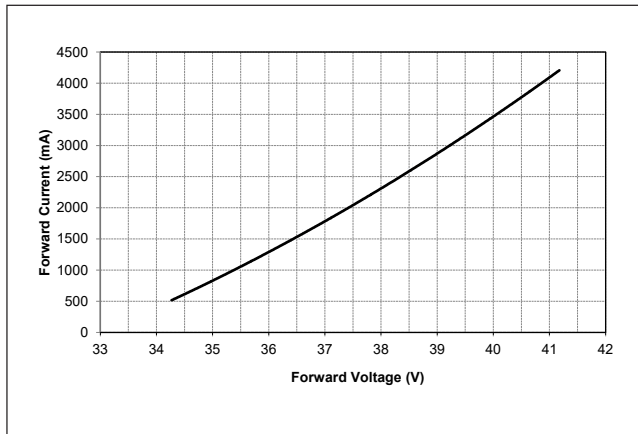

Figure 4: Vero 29B Typical Relative Flux vs. Current

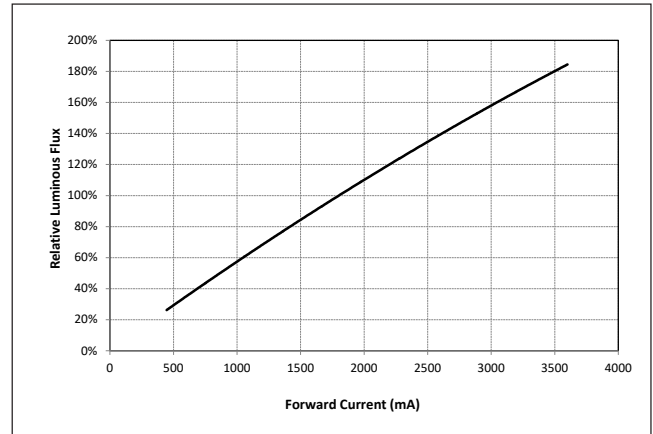

Figure 5: Vero 29C Typical Relative Flux vs. Current

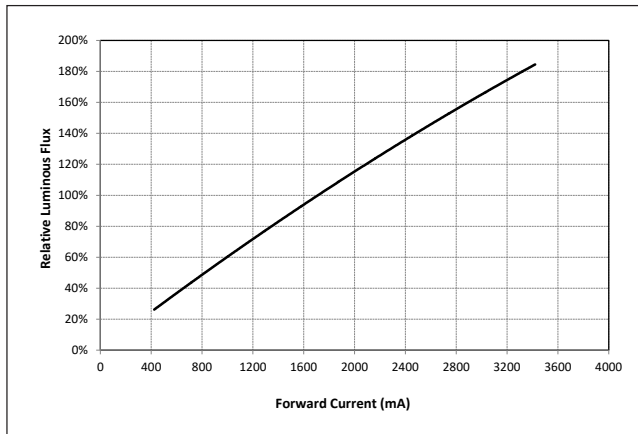
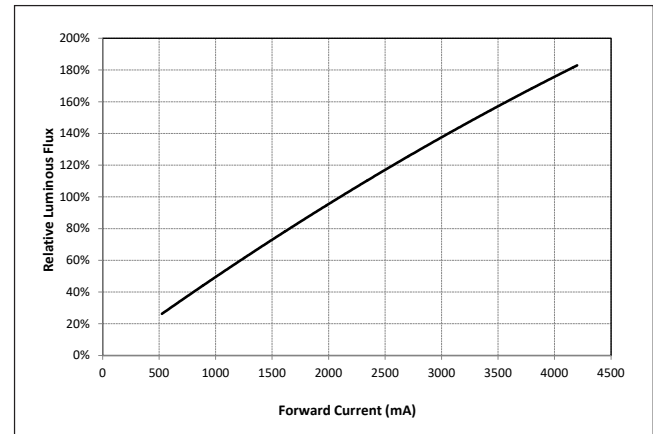

Figure 6: Vero 29D Typical Relative Flux vs. Current



Notes for Figures 1-6:

1. Bridgelux does not recommend driving high power LEDs at low currents. Doing so may produce unpredictable results. Pulse width modulation (PWM) is recommended for dimming effects.
2. Products tested under pulsed condition (10ms pulse width) at nominal test current where T_J (junction temperature) = T_C (case temperature) = 25°C.

Performance Curves

Figure 7: Typical DC Flux vs. Case Temperature

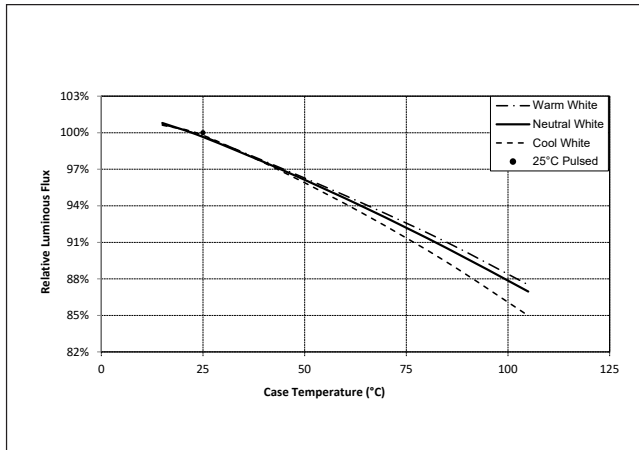

Figure 8: Typical DC ccy Shift vs. Case Temperature

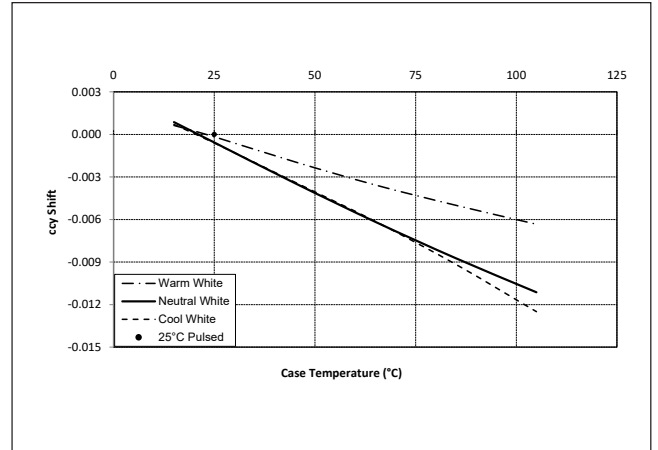

Figure 9: Typical DC ccx Shift vs. Case Temperature

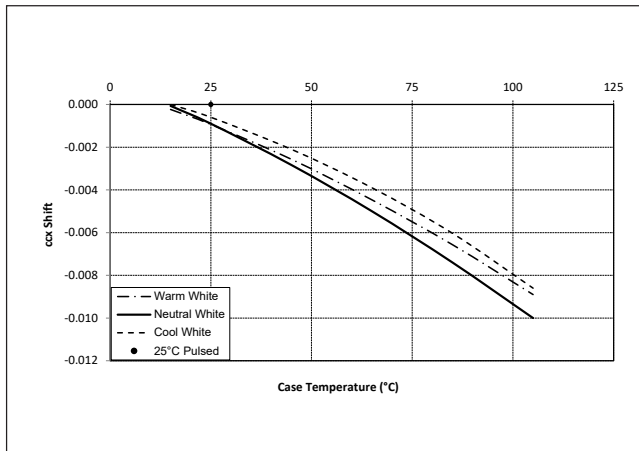
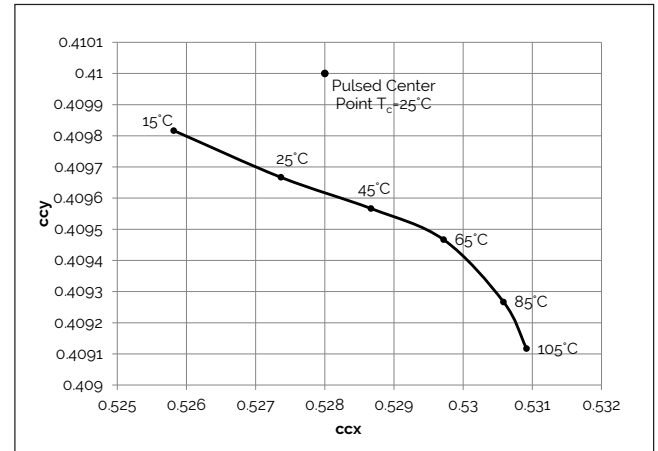

Figure 10: 2000K, 65 CRI Color Shift vs. Case Temperature



Notes for Figures 7 - 9:

1. Characteristics shown for warm white based on 3000K and 80 CRI.
2. Characteristics shown for neutral white based on 4000K and 80 CRI.
3. Characteristics shown for cool white based on 5000K and 70 CRI.
4. For other color SKUs, the shift in color will vary. Please contact your Bridgelux Sales Representative for more information.

Performance Curves

Figure 11: 1750K Color Shift vs. Case Temperature¹

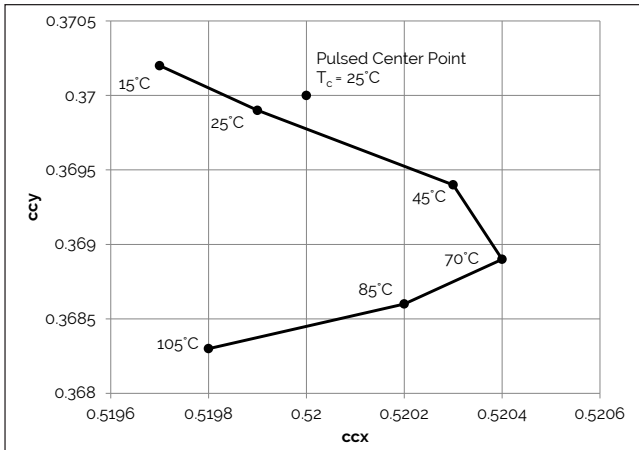

Figure 12: 2500K Color Shift vs. Case Temperature¹

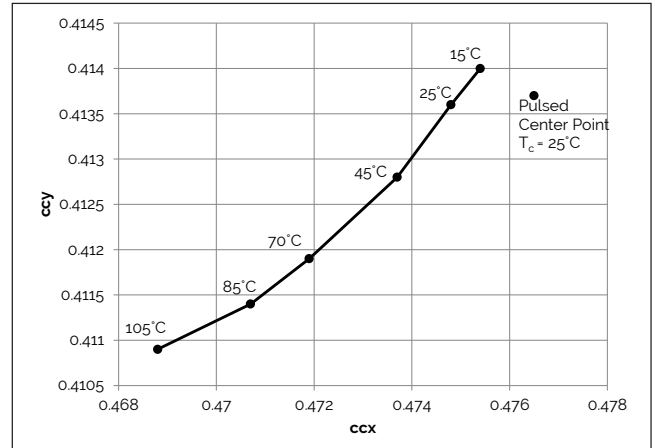

Figure 13: 5600K Color Shift vs. Case Temperature^{1,3}

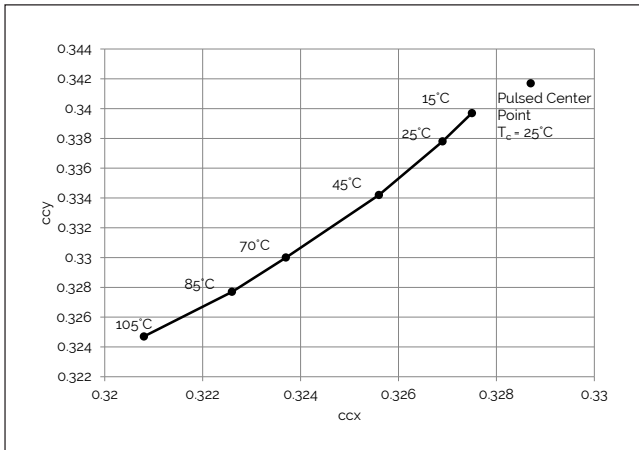

Figure 14: 3000K, Class A Color Shift vs. Case Temperature¹

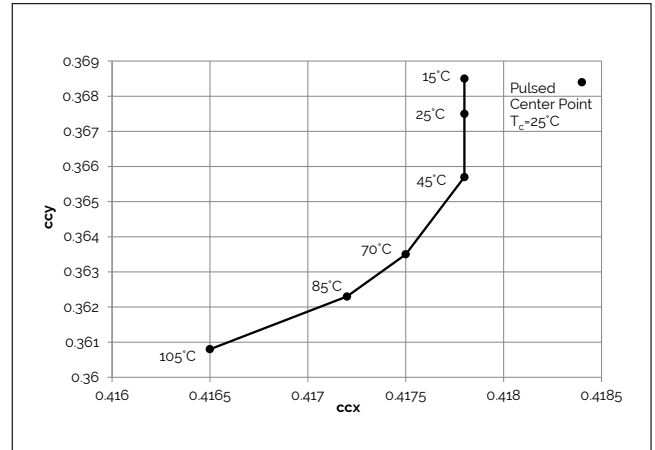

Figure 15: 3500K, Class A Color Shift vs. Case Temperature¹

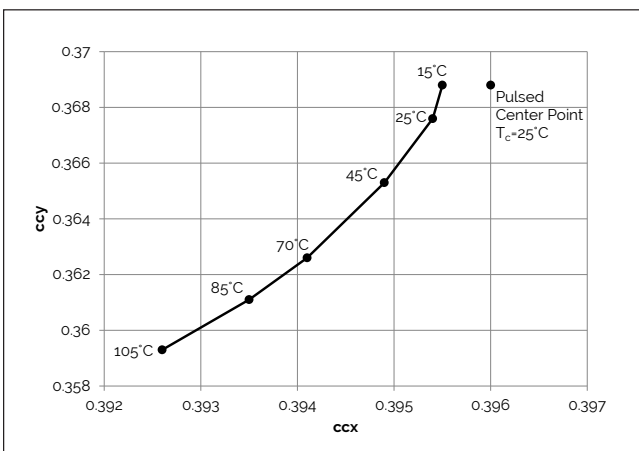
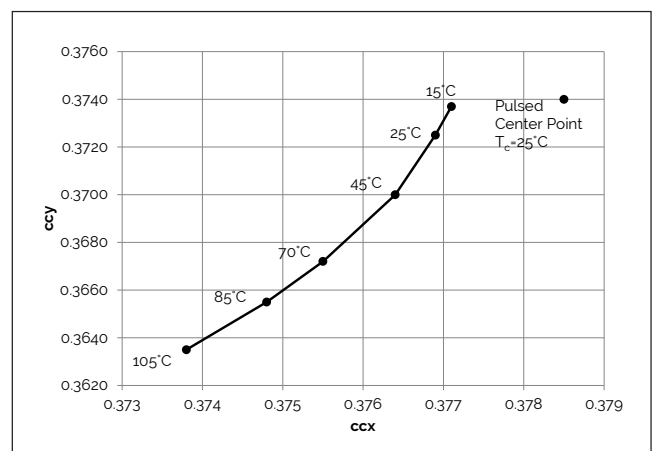

Figure 16: 4000K, Class A Color Shift vs. Case Temperature¹



Notes for Figures 10-16:

1. Measurements made under DC test conditions at the nominal drive current.
2. Typical color shift is shown with a tolerance of ± 0.002 .
3. Color shift shown for product hot targeted at $T_c = 85^\circ\text{C}$

Performance Curves

Figure 17: Vero 29D Drive Current Derating Curve

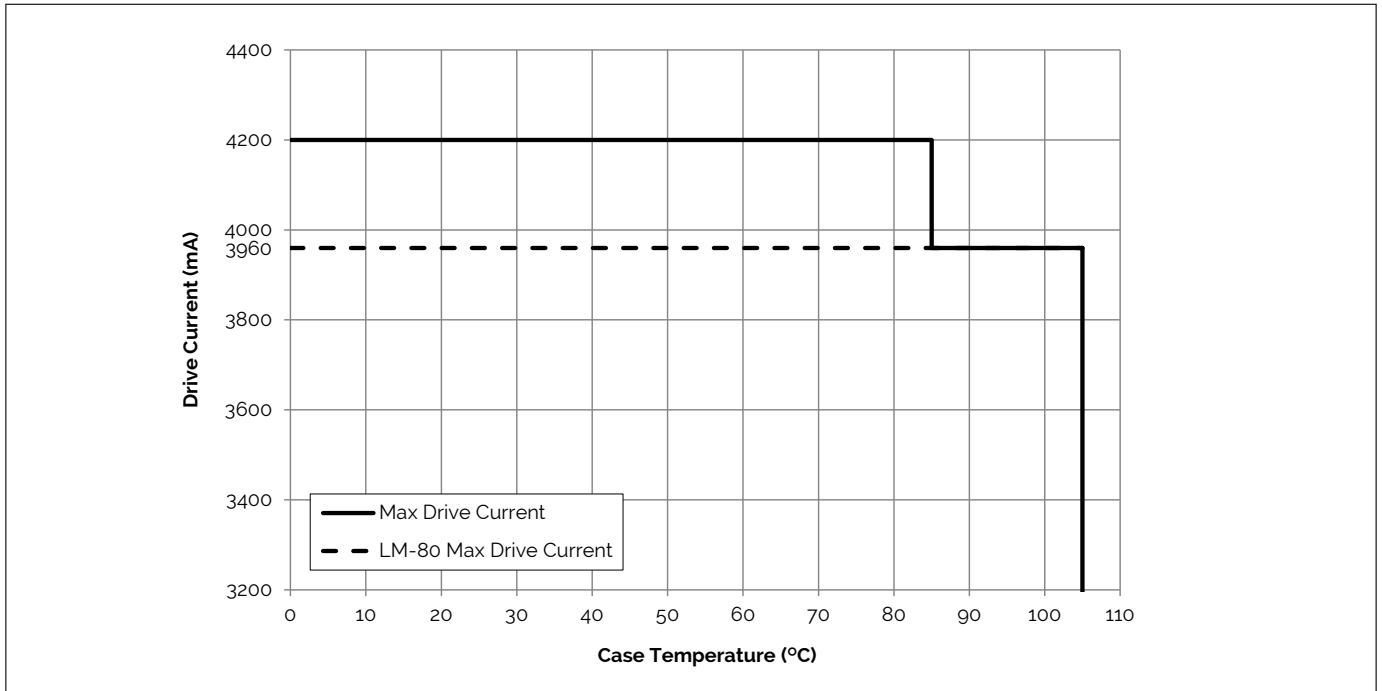

Notes for Figure 17:

1. The maximum allowable drive current for the Vero 29D product is dependent on the operating case temperature. Please refer to the Product Feature Map (page 2) for the location of the T_c Point
2. LM-80 Max Drive Current must not be exceeded in order to meet LM-80 lifetime projections.
3. Lumen maintenance (L70) and lifetime predictions are valid for drive current and case temperature conditions used for LM-80 testing as included in the applicable LM-80 test report for these products. Contact your Bridgelux sales representative for LM-80 report.

Typical Radiation Pattern

Figure 18: Typical Spatial Radiation Pattern

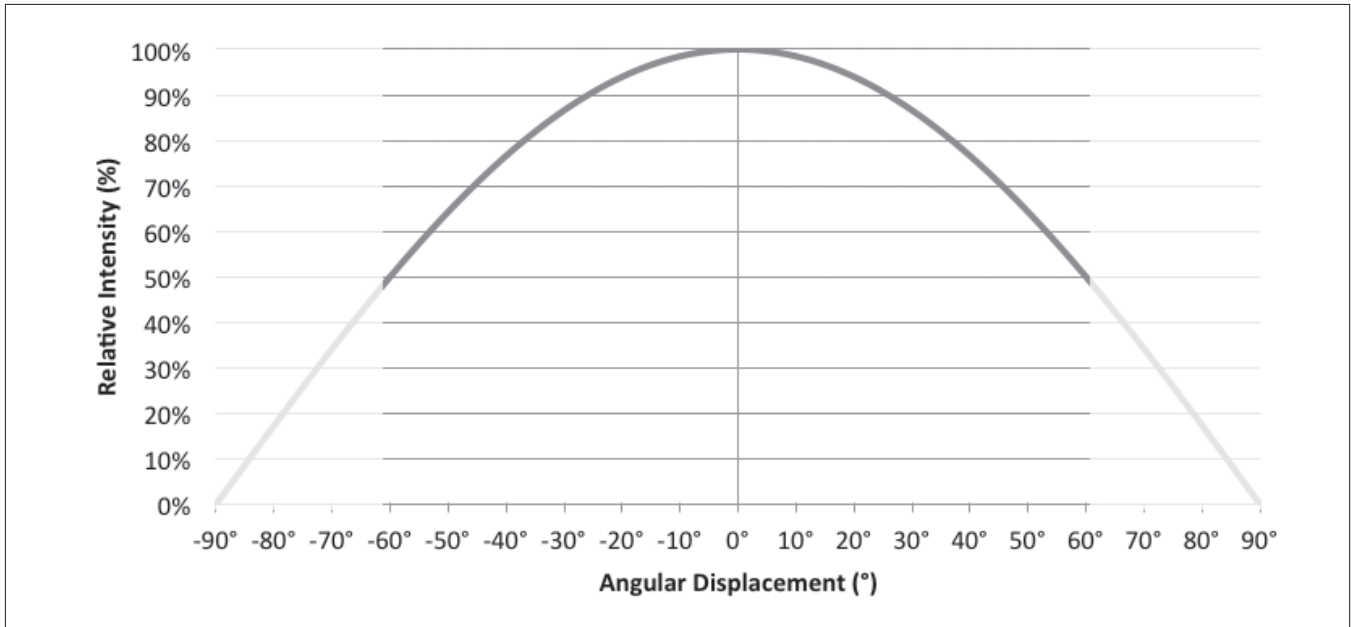

Notes for Figure 18:

1. Typical viewing angle is 120°.
2. The viewing angle is defined as the off axis angle from the centerline where intensity is ½ of the peak value.

Figure 19: Typical Polar Radiation Pattern

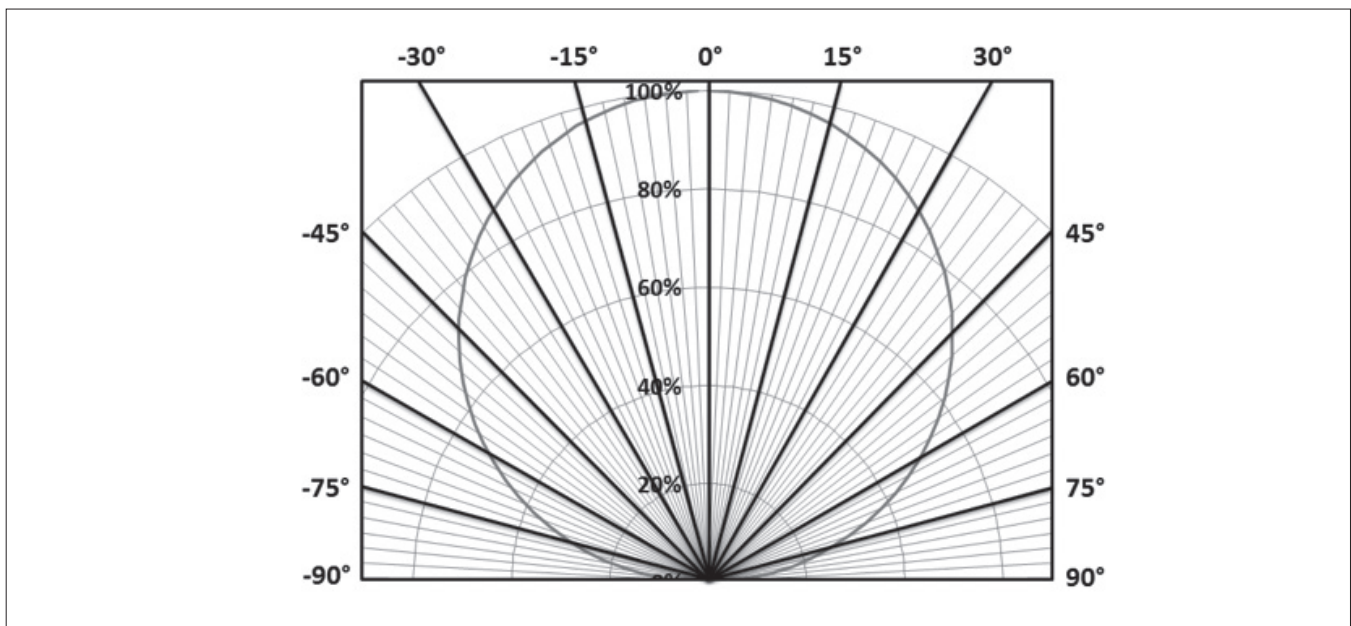

Typical Color Spectrum

Figure 20: Typical Color Spectrum

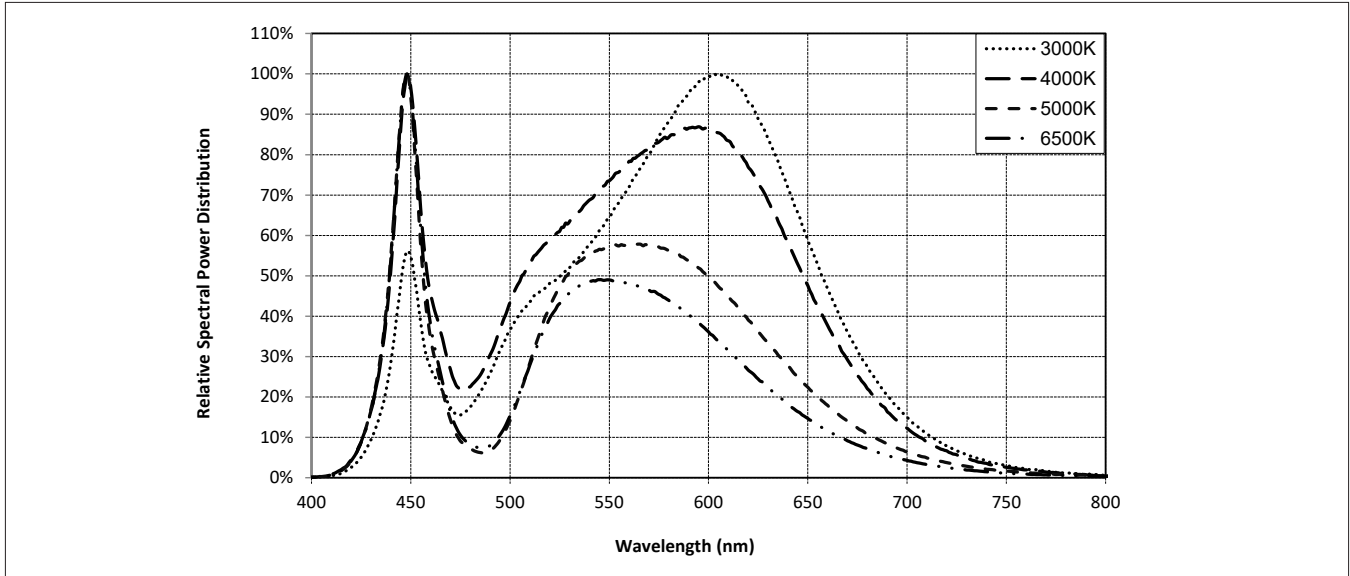

Notes for Figure 20:

1. Color spectra measured at nominal current for $T_j = T_c = 25^\circ\text{C}$.
2. Color spectra shown is 3000K and 80 CRI.
3. Color spectra shown is 4000K and 80 CRI.
4. Color spectra shown is 5000K and 70 CRI.
4. Color spectra shown is 6500K and 70 CRI.

Figure 21: Typical Color Spectrum for Vero 29 with Décor Series

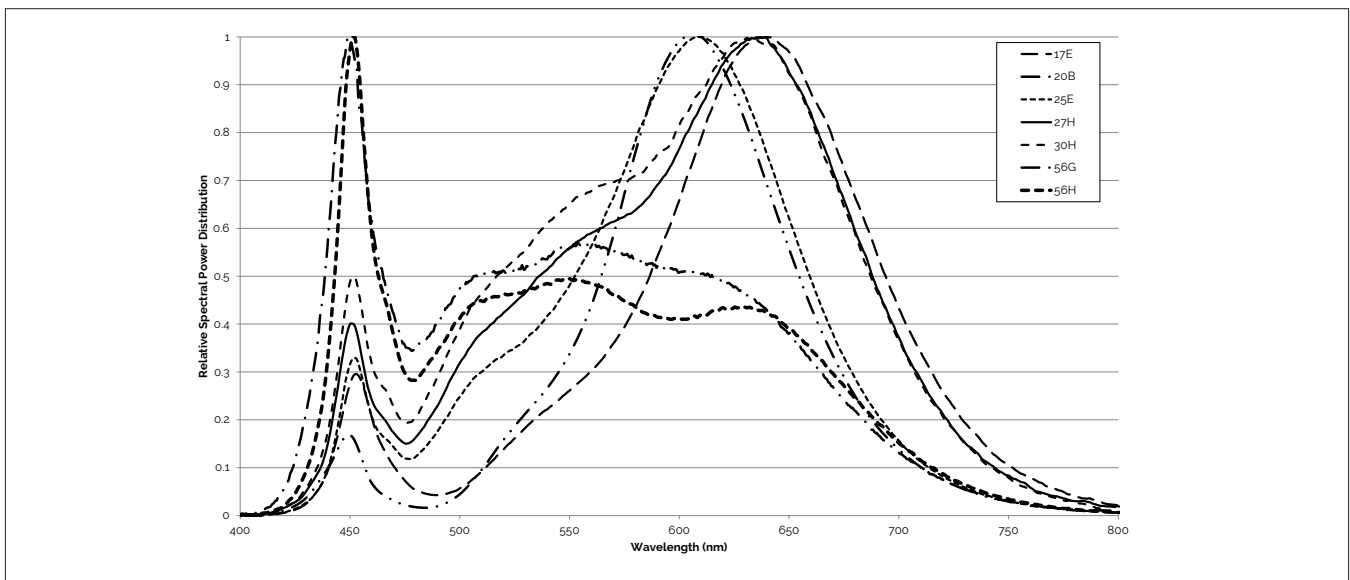

Note for Figure 21:

1. Color spectra measured at nominal current for $T_j = T_c = 25^\circ\text{C}$.

Mechanical Dimensions

Figure 22: Drawing for Vero 29 LED Array

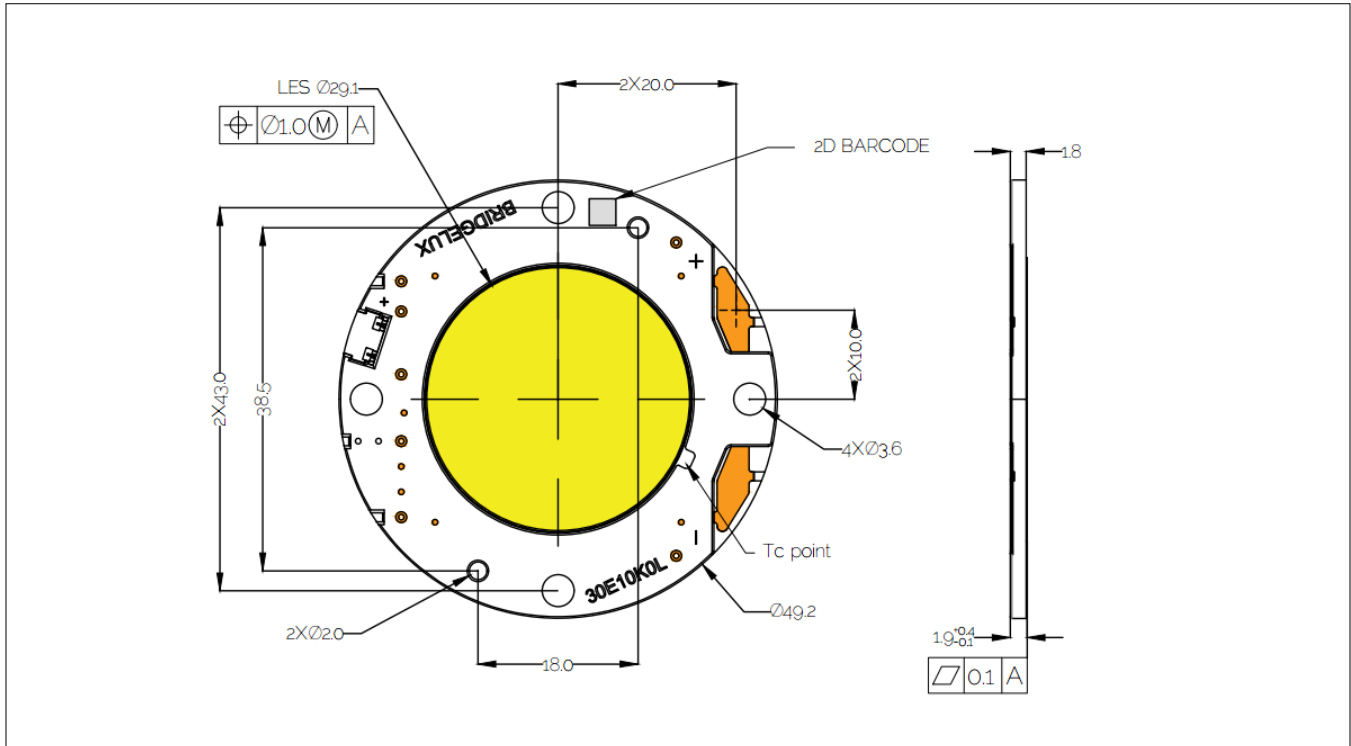

Notes for Figure 22:

1. Drawings are not to scale.
2. Drawing dimensions are in millimeters.
3. Unless otherwise specified, tolerances are $\pm 0.10\text{mm}$.
4. Mounting holes (4X) are for M3 screws.
5. Bridgelux recommends four tapped holes for mounting screws with $43.0 \pm 0.10\text{mm}$ center-to-center spacing.
6. Screws with flat shoulders (pan, dome, button, round, truss, mushroom) provide optimal torque control. Do NOT use flat, countersink, or raised head screws.
7. Solder pads and connector port are labeled "+" and "-" to denote positive and negative, respectively.
8. It is not necessary to provide electrical connections to both the solder pads and the connector port. Either set may be used depending on application specific design requirements.
9. Refer to Application Notes AN30 and AN31 for product handling, mounting and heat sink recommendations.
10. The optical center of the LED Array is nominally defined by the mechanical center of the array to a tolerance of $\pm 0.2\text{mm}$.
11. Bridgelux maintains a flatness of 0.10mm across the mounting surface of the array.

Color Binning Information

Figure 23: Graph of Warm and Neutral White Test Bins in xy Color Space

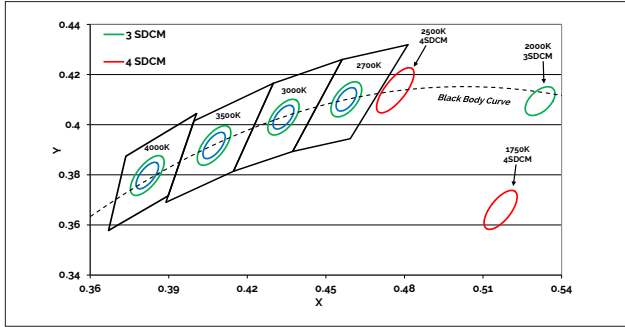

Note: Pulsed Test Conditions, $T_c = 25^\circ\text{C}$

Table 9: Warm and Neutral White xy Bin Coordinates and Associated Typical CCT

Bin Code	1750K	2000K	2500K	2700K	3000K ¹	3500K ¹	4000K ¹
ANSI Bin (for reference only)	-	-	-	(2580K - 2870K)	(2870K - 3220K)	(3220K - 3710K)	(3710K - 4260K)
73 (3 SDCM)	-	-	-	(2651K - 2794K)	(2968K - 3136K)	(3369K - 3586K)	(3851K - 4130K)
72 (2 SDCM)	-	-	-	(2674K - 2769K)	(2995K - 3107K)	(3404K - 3548K)	(3895K - 4081K)
Center Point (x,y)	(0.5167, 0.336)	(0.5280, 0.4100)	(0.4765, 0.4137)	(0.4578, 0.4101)	(0.4338, 0.403)	(0.4073, 0.3917)	(0.3818, 0.3797)

Notes for Table 9:

- Color Binning information excludes Decor Series Class A products. Please contact your Bridgelux Sales Representative for more information.
- Bridgelux maintains a tolerance of +/- 0.007 on x and y color coordinates in the CIE 1931 color Space.

Figure 24: Graph of Cool White Test Bins in xy Color Space

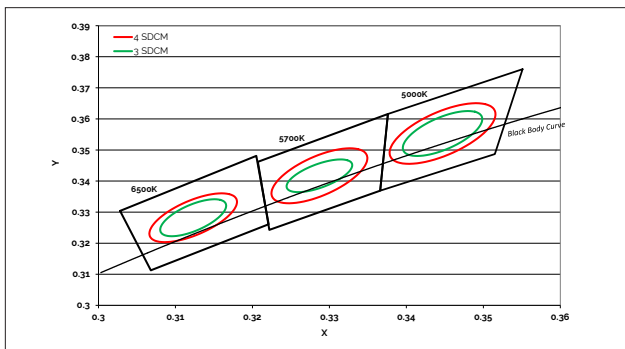

Note: Pulsed Test Conditions, $T_c = 25^\circ\text{C}$

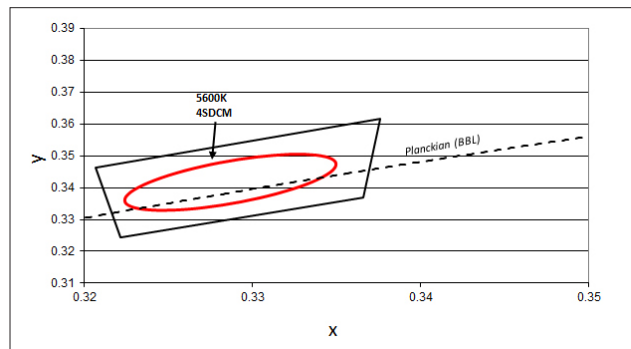

Note: Pulsed Test Conditions, $T_c = 25^\circ\text{C}$

Table 10: Cool White xy Bin Coordinates and Associated Typical CCT (product is hot targeted to $T_c = 85^\circ\text{C}$)

Bin Code	5000K	5600K ¹	5700K	6500K
ANSI Bin (for reference only)	(4745K - 5311K)	(5310K - 6020K)	(5312K - 6022K)	(6022K - 7042K)
74 (4 SDCM)	(4801K - 5282K)	(5475K - 5830K)	(5395K - 5970K)	(6200K - 6910K)
73 (3 SDCM)	(4835K - 5215K)	(5490K - 5820K)	(5460K - 5891K)	(6279K - 6811K)
Center Point (x,y)	(0.3447, 0.3553)	(0.3293, 0.3423)	(0.3287, 0.3417)	(0.3123, 0.3282)

Notes for Table 10:

- Select configurations with a CCT of 5600K are available with center point targets at $T_c = 85^\circ\text{C}$ or $T_c = 25^\circ\text{C}$.
- Bridgelux maintains a tolerance of +/- 0.007 on x and y color coordinates in the CIE 1931 color Space.

Packaging and Labeling

Figure 25: Drawing for Vero 29 Packaging Tray

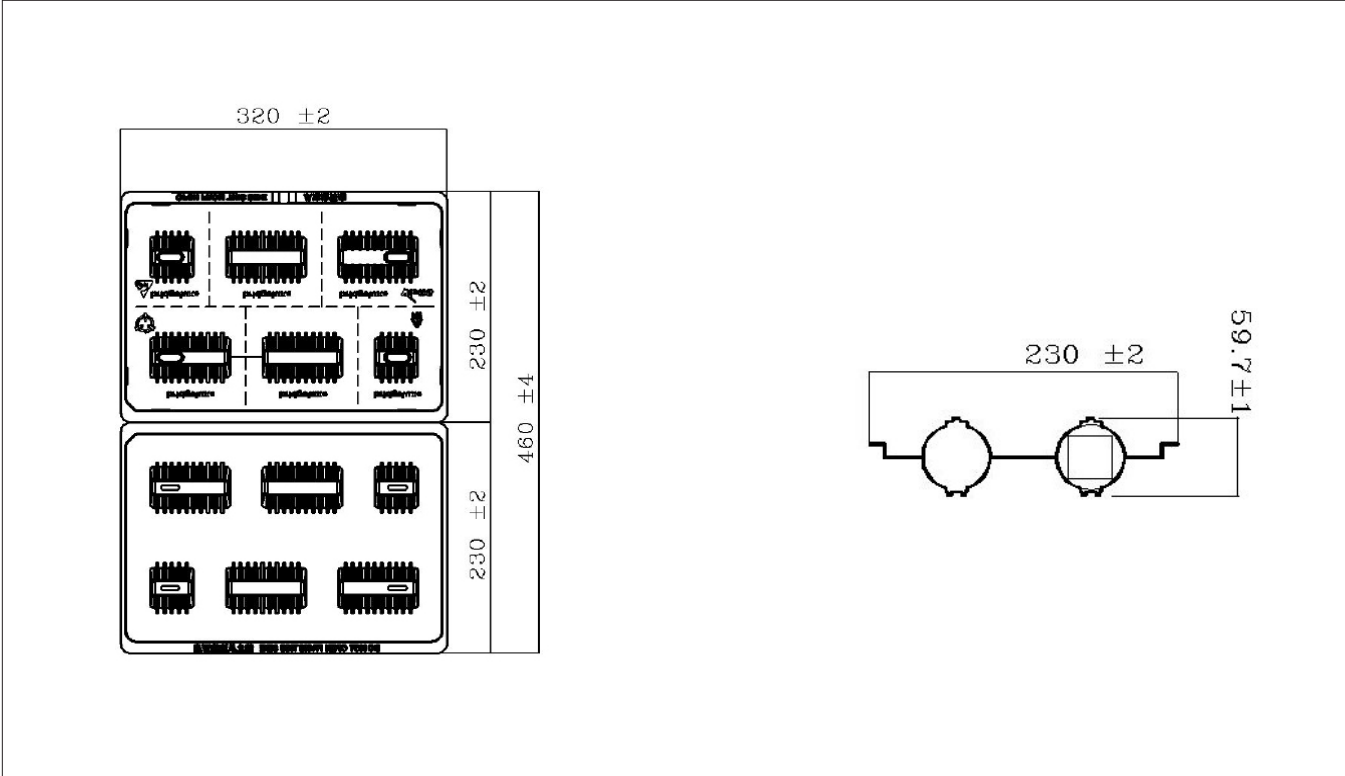

- Notes for Figure 25:
1. Dimensions are in millimeters.
 2. Drawings are not to scale.

Packaging and Labeling

Figure 26: Vero Series Packaging and Labeling

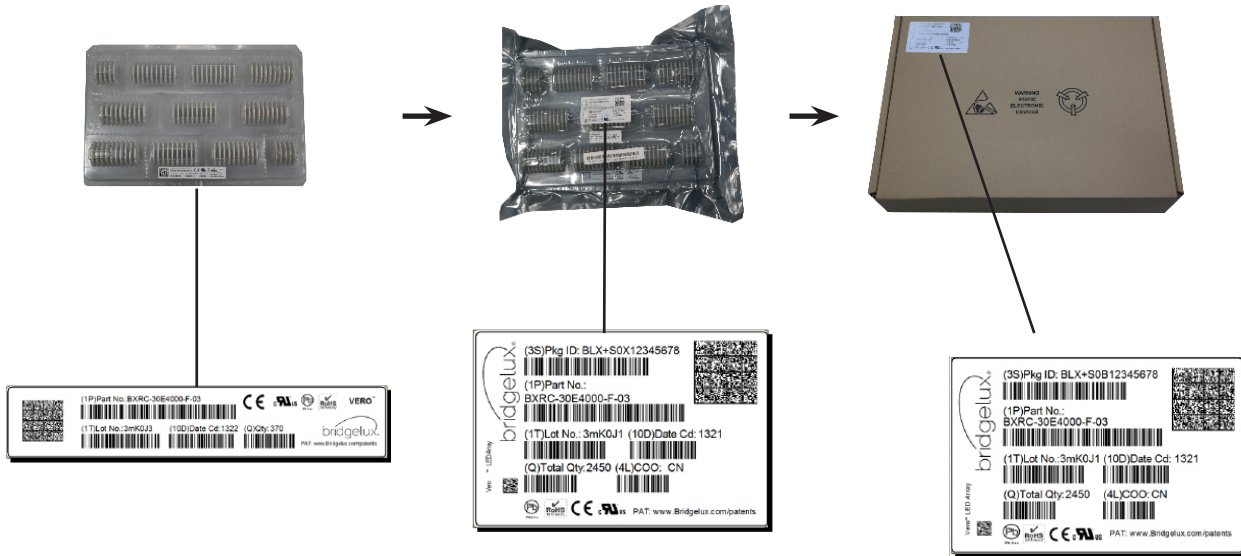

Notes for Figure 26:

1. Each tray holds 50 COBs.
2. Each tray is vacuum sealed in an anti-static bag and placed in its own box.
3. Each tray, bag and box is to be labeled as shown above.

Figure 27: Gen. 7 Product Labeling

Bridgelux COB arrays have laser markings on the back side of the substrate to help with product identification. In addition to the product identification markings, Bridgelux COB arrays also contain markings for internal Bridgelux manufacturing use only. The image below shows which markings are for customer use and which ones are for Bridgelux internal use only. The Bridgelux internal manufacturing markings are subject to change without notice, however these will not impact the form, function or performance of the COB array.



Customer Use- 2D Barcode
Scannable barcode provides product part number and other Bridgelux internal production information.

Customer Use- Product part number

30E10K0C 73 2F

Customer Use- V_i Bin Code
included to enable greater luminaire design flexibility. Refer to ANg2 for bin code definitions.

Design Resources

Application Notes

Bridgelux has developed a comprehensive set of application notes and design resources to assist customers in successfully designing with the Vero product family of LED array products. For all available application notes visit www.bridgelux.com.

Optical Source Models

Optical source models and ray set files are available for all Bridgelux products. For a list of available formats, visit www.bridgelux.com.

3D CAD Models

Three dimensional CAD models depicting the product outline of all Bridgelux Vero LED arrays are available in both IGS and STEP formats. Please contact your Bridgelux sales representative for assistance.

LM80

LM80 testing has been completed and the LM80 report is now available. Please contact your Bridgelux sales representative for LM-80 report.

Precautions

CAUTION: CHEMICAL EXPOSURE HAZARD

Exposure to some chemicals commonly used in luminaire manufacturing and assembly can cause damage to the LED array. Please consult Bridgelux Application Note AN31 for additional information.

CAUTION: RISK OF BURN

Do not touch the Vero LED array during operation. Allow the array to cool for a sufficient period of time before handling. The Vero LED array may reach elevated temperatures such that could burn skin when touched.

CAUTION

CONTACT WITH LIGHT EMITTING SURFACE (LES)

Avoid any contact with the LES. Do not touch the LES of the LED array or apply stress to the LES (yellow phosphor resin area). Contact may cause damage to the LED array.

Optics and reflectors must not be mounted in contact with the LES (yellow phosphor resin area). Optical devices may be mounted on the top surface of the plastic housing of the Vero LED array. Use the mechanical features of the LED array housing, edges and/or mounting holes to locate and secure optical devices as needed.

Disclaimers

MINOR PRODUCT CHANGE POLICY

The rigorous qualification testing on products offered by Bridgelux provides performance assurance. Slight cosmetic changes that do not affect form, fit, or function may occur as Bridgelux continues product optimization.

STANDARD TEST CONDITIONS

Unless otherwise stated, array testing is performed at the nominal drive current.

About Bridgelux: Bridging Light and Life™

At Bridgelux, we help companies, industries and people experience the power and possibility of light. Since 2002, we've designed LED solutions that are high performing, energy efficient, cost effective and easy to integrate. Our focus is on light's impact on human behavior, delivering products that create better environments, experiences and returns—both experiential and financial. And our patented technology drives new platforms for commercial and industrial luminaires.

For more information about the company, please visit
bridgelux.com
twitter.com/Bridgelux
facebook.com/Bridgelux
youtube.com/user/Bridgelux
linkedin.com/company/bridgelux-inc-_2
WeChat ID: BridgeluxInChina



46410 Fremont Boulevard
Fremont, CA 94538 U.S.A.
Tel (925) 583-8400
www.bridgelux.com